



PARTS & ACCESSORIES 2016/17





Parts Catalogue 2016/17

For over 50 years, people have put their trust in our trailers. As specialists in trailer design and engineering, we have continued to set the standard both in the UK and worldwide. We know that quality, strength, value and ease of maintenance are of vital importance to you. That's why we have made them the driving force behind everything we do. With a low rate of depreciation, buying an Ifor Williams Trailer is guaranteed to be a worthwhile investment.

This catalogue aims to provide customers with a comprehensive range of Parts & Accessories for their trailer in order to maintain its condition and increase its longevity.

Ifor Williams Parts & Accessories can be purchased through your local Ifor Williams Distributor, or direct through Ifor Williams Trailers Ltd. Our Parts & Accessories are all backed by prompt service, customer support and total dedication to keep you on the road.

To find the correct part for your trailer, use the contents table overleaf, search the index at the back of the catalogue or simply browse the range of Parts & Accessories on offer.

Parts are also available to search at: www.iwt.co.uk



Contents



**Distributor Contact
Details** 4 - 5

Trailer Range 7 - 21

Identifying your Trailer 22 - 23

**IWT Collection, Trailer
Cam & Gift Idea's** 25 - 29

Brakes 31 - 35

**Running Gear, Wheel
Equipment & Mudguards** 37 - 45

**Couplings & Trailer
Support** 47 - 55

**Trailer Security & Load
Restraint** 57 - 58

Hardware & Ironmongery 60 - 65

Lighting & Electrical 67 - 74

Winches 76 - 82

Model Specific 84 - 145

**Ply Coated Panels &
Flooring** 146 - 149

**Ordering Information &
Terms & Conditions** 150 - 155



Spare parts and accessories can be ordered through our national and international distributor network; contact details are listed on page 5 or page 153.

Our knowledgeable network will be pleased to help you with your inquiry.



Heavy or Bulky Items

Any item marked with this symbol cannot be ordered directly from Ifor Williams Trailers Ltd. These items must be ordered through one of our distributors.

IFOR WILLIAMS TRAILERS IWT BROCHURE COLLECTION



BRITAIN'S LEADING
TRAILER MANUFACTURER





IFOR WILLIAMS TRAILERS DISTRIBUTORS - UK & IRELAND

Northern England

- 1 **Barlow Trailers Ltd**
Leyland (01772 600395)
sales@barlowtrailers.co.uk
- 2 **Guy Machinery Ltd**
Clitheroe (01200 445555)
parts@guymachinery.co.uk
- 3 **Alan Tuer Ltd**
Carlisle (01228 672407)
alantuer@btconnect.com
- 4 **Tony Sharp**
Broughton in Furness
(01229 716445)
tsharptrailers@btconnect.com
- 5 **Swillington Trailer Centre Ltd**
Leeds (0113 287 1463)
swillingtontc@btconnect.com
- 6A **Ripon Trailer Centre**
Ripon (01765 698948)
ripontc@riponfarmservices.co.uk
- 6B **Ripon Farm Services**
Hull (01964 622351)
ripontc@riponfarmservices.co.uk
- 6C **Ripon Farm Services**
Stockton (01740 630254)
ripontc@riponfarmservices.co.uk
- 7 **JG Paxton & Sons Ltd**
Pity Me, Durham (0191 3847111)
info@paxtons.co.uk
- 8A **Thomas Sherriff & Co Ltd**
Alnwick (01665 603555)
donaldj@thomassherriff.co.uk
- 8B **Thomas Sherriff & Co Ltd**
Berwick (01289 306697)
donaldj@thomassherriff.co.uk

Central England

- 9 **Barnwell Trailers Ltd**
Peterborough (01832 272218)
Giles@barnwelltrailers.co.uk
- 10 **HFB Trailers Leek Ltd**
Leek (01538 306212)
sales@hfbtrailers.com
- 11 **Norfolk Trailers Ltd**
Norwich (01603 404302)
sales@norfolktrailers.co.uk
- 12 **Morris Bufton & Co Ltd**
Ludlow (01584 872244)
john@morrisbufton.co.uk
- 13 **Ross Farm Machinery Ltd**
Ross on Wye (01989 768811)
postroom@rossfarm.co.uk
- 14 **Scott Trailers**
Walcott (01526 860317)
office@scott-trailers.co.uk
- 15 **T & A Trailers**
Aldridge (01922 452456)
mail@tatrailers.co.uk
- 16 **Whitehall Trailers**
Stockton (01926 812088)
whitehalltrailer@aol.com

South West England

- 17 **Boulter Mead Ltd**
North Petherton (01278 661586)
sales@boultermead.com
- 18 **Devizes Trailer Centre**
Devizes (01380 721758)
info@devizestailers.com
- 19 **CJ Cox Ltd**
Sturminster Newton
(01258 473176)
cjcoxstores@btconnect.com
- 20 **Winston Pincombe**
Chulmleigh (01769 580900)
winston.pincombe@btconnect.com
- 21 **P R J Engineering Ltd**
Launceston (01566 782794)
sales@prjengineering.co.uk
- 22 **Vincent Tractors Ltd**
St Columb (01726 860332)
stores@vincenttractors.co.uk

Central South England

- 23 **T H White Ltd**
Reading (01189 760088)
trailerspares@thwhite.co.uk
- 24 **Cotswold Trailers Ltd**
Cheltenham (01451 851007)
cotswold.trailer@outlook.com
- 25 **Blains Trailers & Tyres Ltd**
Hemel Hempstead (01442 842419)
blainstrailers@aol.com
- 26 **New Forest Farm Machinery Ltd**
Ringwood (01425 472572)
Parts@newforestfarm.com

South East England

- 27 **Agriservices**
Blackmore (01277 822516)
sales@agriservices.co.uk
- 28 **John Page Trailers**
Ashford (01580 291088)
contact@johnpagetrailers.co.uk
- 29 **Universal Trailers**
Billingshurst (01403 782862)
info@universal-trailers.co.uk
- 30 **G T Towing Ltd**
Hatfield (01707 262526)
sales@gttowing.co.uk
- 31 **Agroco Trailers Ltd**
Ipswich (01473 657571)
info@agrocotrailers.co.uk

Wales

- 32A **Ifor Williams Trailers Ltd**
Corwen (01490 412527)
sales@iwt.co.uk
- 32B **Ifor Williams Trailers Ltd**
Deeside (01244 281888)
sales@iwtdeeside.co.uk
- 33 **J & C Griffiths and Son**
Talgarth (01874 711317)
sales@jandcgriffithsandson.co.uk
- 34A **Riverlea Tractors Ltd**
Cowbridge (01446 775602)
parts.la@riverlea.co.uk
- 34B **Riverlea Tractors Ltd**
Whitland (01994 240644)
parts.wh@riverlea.co.uk
- 35 **Ross Farm Machinery Ltd**
Raglan (01291 690205)
postroom@rossfarm.co.uk
- 36 **Mason Bros**
Bridgend (01656 723655)
info@masonbros.co.uk

Scotland

- 37A **T H Jenkinson**
Castle Douglas (01556 504133)
tom@thjenkinson.co.uk
- 37B **T H Jenkinson**
Whitefordhill (01292 619193)
ayr@thjenkinson.co.uk
- 38 **Stirling Trailer Centre**
Stirling (01786 833424)
parts@stirlingtrailercentre.co.uk
- 39A **Thomas Sherriff & Co Ltd**
Coldstream (01890 840550)
donaldj@thomassherriff.co.uk
- 39B **Thomas Sherriff & Co Ltd**
Haddington (01620 823132)
donaldj@thomassherriff.co.uk
- 39C **Thomas Sherriff & Co Ltd**
Stow (01578 730282)
stow@thomassherriff.co.uk
- 39D **Thomas Sherriff & Co Ltd**
Dunbar (01368 862736)
sherriff.dunbar@thomassherriff.co.uk
- 40 **Duncan McIntosh Trailers Ltd**
Brechin (01356 624600)
spares@duncanmcintosh.co.uk
- 41A **D & R Alexander & Son**
Inverness (01463 248268)
sales@dralexanderson.co.uk
- 41B **D & R Alexander & Son**
Thurso (01847 811365)
sales@dralexanderson.co.uk
- 42A **Balgownie Ltd**
Inverurie (01467 621493)
info@balgownieltd.co.uk
- 42B **Balgownie Ltd**
Turrieff (01888 530800)
info@balgownieltd.co.uk

Northern Ireland

- 43A **A J C Lamont Trailers**
Coleraine (028 7034 3563)
info@lamonttrailers.com
- 43B **A J C Lamont Trailers**
Lisburn (028 9266 6804)
info@lamonttrailers.com
- 44 **THJenkinson & Co**
Armagh (028 3756 8484)
sales@jenkinsontrailers.co.uk

Ireland

- 45 **Westwood Trailers Ltd**
Naas 00353 (0)45 876053
parts@westwoodtrailers.com

For overseas customers please look at the worldwide distributor section of our website and contact your local distributor. www.iwt.co.uk

Trailer Range

Introducing the full Ifor Williams range



Ifor Williams trailers produces over 10 main trailer model ranges with an extensive selection of sizes and variants within each range.

A brief description of the trailers and their main characteristics are summarised below. If you want more information please go on our website to the relevant trailer section and download the full brochure or contact your local distributor.

Contents

Page

Horsebox Trailers	8
Large Horsebox Trailers and Eventa	8 & 9
Livestock Trailers - Low Headroom	10
Livestock Trailers - Large Models	11
General Duty Trailers	12
Flatbed Trailers	13
Beavertail & Tiltbed Trailers	14
Tipping Trailers	15
Plant Trailers - GH, GP & GX Ranges	16
Car Transporter Trailers	17
Transporta	18
Box Van Trailers	19
Unbraked Trailers	20
Q Range	21



The Ifor Williams trailer range has been designed with you and your horse in mind. Combining the much loved qualities of the Ifor Williams range with continuous design improvements ensures that you are towing the safest and strongest horsebox trailer we have ever built. Trailer exteriors have a striking overall appearance which complements the towing vehicle. However, the beauty of our horsebox is not just skin deep, the comfort and safety of your horse has always been our main consideration in the design of our horsebox range.

Our trailers have undergone rigorous testing not only within our own test facilities, but also at independent test tracks. There are three models in the range; one single and two double. All trailers are available with an offload front ramp and a grooms' door fitted as standard.

HB506 and HB511 Double Horsebox Models – Both models are suitable for two horses. The HB506 can accommodate two horses up to 16.2hh; the HB511 is slightly longer, wider and will carry two 17.2hh horses. Both models feature a pair of side windows, and have a large inspection window which allows more daylight into the trailer. Centre partitions and breast and breeching bars are fitted as standard.

HB403 Single Horsebox – As a single horsebox, the HB403 provides more stall width than our double horsebox models and offers enough headroom to take one 16.2hh horse.

Being a narrower trailer, the HB403 is easier to tow and produces less wind resistance when towing. The HB403 is ideal for transporting nervous horses that require a wider stall and may prefer to travel alone.



HB506 with right offload ramp in Silver



HB403 with right offload ramp in Bala Blue



Whether you are a livery yard, trekking centre, riding school or private individual with a string of ponies, this trailer, with a maximum gross weight of 3500kg, makes an ideal workhorse.

HB510XL

The HB510XL offers the flexibility of carrying two horses up to 17.2hh or up to four ponies. The HB510XL comes with headroom of 2.3m and a locking groom's door as standard. With its 14' internal length the HB510XL offers either a range of telescopic partitions, suitable for ponies*, or a single centre partition allowing two horses to face forward.

HB610

The HB610 represents our largest trailer and can carry two large horses up to 17.2hh with room to spare or up to five ponies. The HB610 has headroom of 2.3m and a locking groom's door fitted as standard. As with the HB510XL, the HB610 has a maximum gross weight of 3500kg. However, by offering additional trailer width, the telescopic partition system allows up to five pony stalls.*

The wide front unload ramp, which comes as standard, makes this model unique and very useful for both horse and owner. † An additional benefit is the extra storage space available in the wind deflector, accessible from inside the trailer.

The sliding windows and roof vents provide a comfortable and safe environment for your horse, ensuring plenty of light and fresh air. Additional comfort is provided through thick rubber floor matting.

*Animals must not be carried adjacent to the groom's door under any circumstances. Please refer to the partition layouts for guidance.

†The HB610 front ramp provides headroom of 1.9m (74") and may not be suitable for front unloading of horses over 16.2hh.





EVENTA

Your Ifor Williams Horsebox can now be a home from home for you as well as your horse.

The Eventa range of horseboxes includes fitted living accommodation options. We have built on our 50 years of experience producing the UK's best trailers to produce this exciting range.

The Eventa comes in two sizes. The Eventa M is suitable for 2 horses whilst the Eventa L is suitable for 2/3 horses/ponies dependant on weight. Moving away from traditional trailers the partitions for the horses are at a herringbone angle – widely used on horsebox lorries.

The standard furniture in the Medium Eventa comprises of seating for three, sleeping for two, dining table, sink unit, drawer unit (with hob and grill fitted on Gold) and cupboard with some hanging space.





P6e Livestock with 20.5 x 8-10 tyres (750Kg)

P6e & P7e

Our P6e & P7e offer small unbraked trailers with outstanding flexibility both on and off road. The livestock versions include aluminium ramp gates, ventilation louvres in the front of the canopy and fixing points for the optional cross division.

P6g & P8g

These two models, the lightest in our braked Livestock range, are designed for those who need a light yet robust means of transporting small types of livestock. Easy to tow, reverse and manoeuvre, the trailers will meet the needs of the most serious farming professionals.

With a maximum gross weight of 1400kg, they can be towed by most large family cars. They provide a payload of 1010kg for the 6' version and 960kg for the 8' version. Both models offer 4' and 5' headroom with a width of 4'.

TA5 4'

The TA5 4' headroom models are slightly wider than the P6 and P8 at 5', and feature wider side vents with flaps giving increased ventilation. With the low headroom and increased floor space, the wind resistance is minimised when towing, a bonus when travelling long distances. The twin axles provide a maximum gross weight of 2700kg. The TA5 4' headroom model is available in 8', 10', 12', and 14' body lengths.



P6 (1400Kg)



TA5 10' (4' headroom)



DP120 (EasyLoad™) with optional ramp side gate extensions

TA5 6' AND 7' H/R

The TA5 range with 6' or 7' headroom is a substantial but narrow trailer, ideal for navigating rural tracks and lanes. The TA5 is available in 8', 10', 12' and 14' body lengths. The 8' and 10' versions have a maximum gross weight of 2700kg while the 12' and 14' heavy duty versions offer 3500kg maximum gross weight.

TA510

The TA510 offers an internal width of 5'10" and is a very popular and widely used means for moving livestock around the roads of Britain and Europe.

Body lengths of 10', 12' and 14' are available, with height options of 6' and 7'. The 14' is also available in 4' headroom. The 7' versions, with optional centre partition fitted, allow 2 16.2hh horses to be transported*. All trailers have a maximum gross weight of 3500kg; payload varies between 2010kg and 2550kg depending on size and specification.

DP120 DUAL PURPOSE TRAILERS

The DP120 range combines a substantial maximum volume and gross weight (3500kg) with the option of a removable container. When the container is removed, the DP120 can be used as a conventional flatbed trailer. Body lengths of 10', 12' and 14' are available, all with standard headroom of 6'. A tri-axle is an option on the 12' model and comes as standard on the 14' version.

RAMP OPTIONS

All three models are available with either the standard ramp or with the award winning EasyLoad™ ramp and folding deck system, designed to enable the handler to load two decks of sheep without having to handle large weights. TA5 and TA510 models are also offered with combination ramp doors allowing forklift loading of bulk feed etc.

*Subject always to the Welfare of Animals (Transport) England Order 2006.



TA5 (6' headroom) with optional ramp side gate extensions



TA510 12' (6' headroom) with optional ramp side gate extensions



GD85 single axle

Our General Duty trailers are at home in almost any environment, with virtually any type of load, from building materials to expedition equipment.

The trailers are built around a welded steel, galvanised chassis with fixed front and side panels. These panels are constructed from galvanised steel and are supported by galvanised steel channel sections.

The General Duty range is offered in width options from 4' to 5'9" (internal width), and length options from 6' to 12'. All models are offered with either a tailboard or rear ramp with assistor.

A number of axle options are available giving a maximum gross weight range from 1400kg to 2700kg.

Mesh sides are available for most models, providing the capability to carry bulky loads such as hedge cuttings and waste packaging.



GD105 with ramp



GD105 with mesh sides and ramp



LM126 with optional dropsides, tailboard and headboard.



LM126

From the smallest LT85 to the largest LM208, all Flatbed models are built around a welded steel, galvanized chassis fitted with bolt-on tapered drawbars and the Ifor Williams beam axle and leaf sprung suspension.

The Flatbed trailer range is normally supplied with twin axles. Tri-axle options are available on our LM6 series models in lengths over 10'.

Eurolight trailers are also available as a flat bed trailer option, see www.iwt.co.uk for more details

With the addition of a winch, rear prop stands and loading skids or the full-width ramp (1.83m/6' in length), the versatile flatbed can be used to carry loads such as small plant, ride-on mowers, mixers, shredders, rollers and a multitude of mobile plant equipment.

A new addition to the range is the LM208, this is the largest Flatbed trailer. The LM208 tri-axle trailer has all the normal features of an Ifor Williams Trailer but has the capacity to transport up to 10 portable toilets. This trailer is available with handrails for the operators' convenience and safety when loading. Alternatively the trailer can be used as a conventional trailer, with or without sides and with its large size the trailer offers great flexibility, including the ability to transport 6m lengths of materials or any large yet relatively light load.

The maximum gross weight for the LT model is 2000kg, whilst the heavier LM models offer between 2700kg and 3500kg.

Tough, adaptable and easy to maintain, all models are fitted with a tough resin-coated plywood platform, spare wheel and jockey wheel as standard. An option of aluminium treadplate covering is available, along with recessed lashing rings. Trailers can be further enhanced with accessories such as a headboard, ladder rack, dropsides or meshside extensions.

BEAVERTAIL

The Beavertail range is offered in width options of 6'6" and 7'6" and length options of 14' and 16'. The lighter LT models offer a maximum gross weight of 2000kg, whilst the heavier LM models offer the maximum gross weight of 3500kg.

Closely related to the flatbed range, with the addition of a sloping rear bed section, these trailers offer the flexibility of a flatbed with the added benefit of a low loading height to the rear of the trailer.

Many of the accessories available on the flatbed range can also be added to further enhance the beavertail range.



LM166B with optional electric winch (and battery) and optional propstands

TILTBED TRAILERS

Our TB range comprises six trailer models all with a width of 2100mm and four length options, two of which are also available with three axles.

With low bed height and reduced loading angles the versatility of this trailer is increased.

Tilting is achieved through the use of a hydraulic pump and ram. A choice of full width ramp, hinged skids or pull out skids are available as well as accessories such as sides, mesh sides and winch.

In addition to the TB range we also have the CT style of tiltbed trailers which complement the TB range



CT166 with 3' loading ramp and optional headboard and drop sides



CT166 shown in tilted position



TB4621-352 with stowable skids shown in tilted position with optional wheel chocks

Introducing the Tipper, a regular on building sites all over the UK and Europe, an Ifor Williams Tipper trailer is the builder's perfect partner.

Three sizes are available

TT2515 bed size 2.5m x 1.5m (8'x5'), the smallest of the range, has a maximum gross weight of 2700kg with the option of a manual or electric hydraulic pump (and self-contained 12v battery). This trailer comes with a strengthened aluminium floor as standard.

Larger models TT3017 (bed size 3.0m x 1.7m (10' x 5'6")) and TT3621 (bed size 3.6m x 2.1m (12' x 6'6")) have electrically operated tipper mechanisms with a self-contained 12v battery as standard. Both have a maximum gross weight of 3500kg and offer all the usual benefits of a tipper trailer, coupled with the superb flexibility of the flatbed range. With the addition of loading skids and rear prop stands, the larger tipper models can also be used to carry plant and machinery.



TT2515



TT3621



GP126 tri-axle

GX, GH and GP Plant trailers

The Ifor Williams Plant trailer range is designed specifically for transporting plant machinery and has been standard equipment for many plant users and plant hire firms since the 1980's across Europe. We offer three distinct styles of plant trailer – the GH range, the GX range and the GP range

GH Plant Trailers

The GH range comprise welded chassis and most models offer a beavertail floor to reduce the loading angle and reduce rockover experienced with tracked equipment . In addition the trailers are supplied with 24mm thick floors meaning the trailers can safely transport not just tracked plant and equipment but also drum rollers and the range is also suitable for carrying many types of access platform.

The GH range is widely used in the Plant hire industry and is available in range of sizes.

Two particularly popular models are the GH94BT, which is widely used for transporting 1 ½ tonne compact excavators, and the GH1054BT which is targeted at 2 ½ tonne compact excavators. The trailers are all available with either full width ramps or with sliding skids.

GX Trailers

The GX range is constructed from folded pre-galvanized sections and is offered in sizes from the GX84 2.5 x 1.2m (8' X 4') to GX126 3.6m x 1.8m (12' x 6'). This very flexible trailer is also available with mesh side extensions and can be ordered with standard or long ramps or sliding skids. The smaller models are only available in 2700kg gross, but the larger sized models are available in 3500kg and are ideal for carrying compact excavators and other tracked equipment as well as dumpers.

GP Trailers

The original Ifor Williams plant trailer, the GP is an open sided welded chassis and is available with a variety of wheel options – including 16" tyres. The entire GP trailer are rated at 3500kg and can be specified with either ramps or skids. Triaxle trailers are available on some models

All ifor williams plant trailers have ramps and skids which are self-supporting and are specially designed for the demands of loading plant and equipment.



GP106 with skids



GH94BT



CT177

CT177

A versatile transporter, wide enough for most light commercials and narrow enough for the smaller car, the CT177 is the ideal trailer for the motor trade or hire professional. Its tilt bed action combined with pull out mini-skids allows for quick and efficient loading of vehicles either under their own power or using one of the winch options available.

The combination of optimum engineering design and high strength materials has produced a trailer with an excellent strength to weight ratio. Wheel arch tops are only 10cm (4") from the bed to give ample door clearance and feature high grip treads for safe entry and exit from the vehicle being carried. Optional heavy duty wheel straps feature a soft-link that will not damage expensive alloy wheels and can be stowed away in the built-in toolbox.

Mini-skids, to give improved ground clearance, can be quickly and easily slid into position. Fully retained at all times they cannot be lost or stolen and once the vehicle is loaded they simply slide back in place within the rear deck.

The removable winch arm is fully adjustable from side to side allowing alignment with off-centre vehicle recovery eyes.



CT136 twin axle

CT136

With three models available, both vehicle recovery and motorsports are catered for within this trailer range.

Utilising the same lightweight construction on all three models, the single (1400kg gross), twin axle (2000kg gross) and heavy duty (2600kg gross) models are lightweight trailers giving a maximum payload capacity of 1000kg, 1500kg and 2100kg respectively.

The optional removable / adjustable front wheel chocks take the guess work out of positioning your vehicle. The heavy duty wheel straps (conveniently stored in the lockable toolbox) can be anchored at any number of perforations provided in the bed.



CT136 single axle

CT115

The CT115 is the smallest trailer in the Ifor Williams Car Transporter range and caters for both vehicle recovery and motorsport. With a gross weight of 1400kg and an unladen weight of only 350kg, this neat trailer boasts a payload over 1000kg. Slightly smaller than the single axle CT136, the CT115 is available with similar optional accessories.



TRANSPORTA

The newest trailer within the range is the **TRANSPORTA**.

The perfect trailer for motorsport enthusiasts, small racing teams and classic car owners, the enclosed car transporter offers protection from the elements whilst transporting and storing high value vehicles. All models feature a durable galvanised steel chassis, with the tiltbed model featuring a manual hydraulic tilting drawbar which accommodates most vehicles and for vehicles with low ground clearance an optional pair of ramp skid extenders are available.

The trailer is available with side opening doors or upward opening doors to allow excellent access to the vehicle. An electrically operated winch is available and the sliding bracket means the whole assembly can move from side to side to allow for variation in vehicle towing eye position. The optional tyre rack and workbench, which are mounted to the front of the trailer, can accommodate a set of differently sized wheels and gives a fully functional working area over a durable large front storage cabinet constructed from lightweight material.

With many other features and accessories available you can create a bespoke enclosed car transporter that suits your requirements.





BV84 single axle model



BV85 with roller shutter

Whatever you need to carry, there's an Ifor Williams Box Van to suit your needs. Take a look at the features and you'll find practicality, durability and reliability built in.

Our Box Vans are available in a choice of three height options, three width options and four length options. Smaller models are available with a choice of single or twin axles. Most models are offered with roller shutter, combination ramp doors or van rear doors, ensuring your trailer is perfect for your needs. The white coated side panels are tough, smart and easy to clean. They provide the classic 'blank canvas' ready to be sign-written and ideal for pre-cut vinyl graphics and logos. All our Braked Box Vans feature an exclusive beam axle and leaf spring suspension system which has been developed for a safe and stable ride. Similar systems are widely used on commercial vehicles, where performance under load is essential. Renowned for its durability and ease of maintenance, the Ifor Williams beam axle system contributes significantly to the low depreciation of our trailers. Our Box Van trailers feature a tapered/curved front section to maximise space and reduce drag. The increase in fuel economy makes a real difference when you are covering long distances.

BV4

The BV4 series is a small trailer with a big heart. It's available as a single or a twin axle, the single axle version being suitable for towing behind many larger family saloons.

The single axle version offers a maximum gross weight of 1400kg, whilst the twin axle version offers 2700kg

BV5 SERIES

The BV5 series is offered with three headroom options: 5ft (which will clear most garage doors), 6ft or 7ft. There are length options of 8ft, 10ft or 12ft. Carrying capacities range from 5.95m³ to 12.12m³.

All sizes come with twin axles giving maximum gross weight of 2700kg.

BV6 SERIES

The BV6 is available in lengths of 10ft and 12ft, and two headroom options: 6ft and 7ft. All models have a maximum gross weight of 3500kg.

With parallel side walls and no wheel arch intrusions, the space inside these trailers is cavernous. The series offers a carrying capacity of up to 14.38m³.



BV126 with combination ramp/doors



P5 tailboard model with optional tarpaulin cover



P6e tailboard model

The Ifor Williams Unbraked trailer range provides a low-cost entry into towing for thousands of new users every year.

Many owners have chosen these trailers for their ease of handling and towing plus their value for money. The extensive features add up to make an unbraked trailer the ideal choice for the smaller load.

On the road they can be towed by a family car by anyone with a licence – minimum licence requirement is category B¹, off road they can even be towed by a quad bike².

P5

The P5 is available with either a tailboard or a ramp and offers excellent strength to weight ratio with a maximum gross weight of 500kg and a payload starting at 359kg. The P5 has a floor area of 1.02m x 1.52m is 0.44m deep. There are a variety of extras available for the P5 including tarpaulin cover, mesh sides and fibreglass lockable hinged lid.

P6e, P7e & P8e

With ramp or tailboard versions, canopy and livestock options, gross weights of 500kg or 750kg on most models and a range of optional accessories, the P6e, P7e and P8e cater for most domestic, light commercial and general farmyard duties.

The P6e has a floor area of 1.21m x 1.98m, the P7e is slightly longer with a floor space of 1.21m x 2.21m. Both versions are available with maximum gross weights of 500kg or 750kg.

The P8e is the largest of the unbraked range. It comfortably carries standard building sheets (typical size of 2.4m x 1.2m) and has a maximum gross weight of 750kg. In addition, the generous width allows the loading of a variety of lawn mowers and quad bikes. The P8e is available with tailboard, a ramp or with an extended ramp version. The extended ramp version has been developed for carrying ride on mowers, which normally have limited ground clearance. Uniquely the extended ramp features an assistor for ease of use.

BV64e

Available with the choice of van style rear doors and flat roof or a convenient roller shutter with an aerodynamic GRP roof moulding. Both models feature a streamlined body and mud wings with the rear prop stands integrated into the wings. The adhesive bonded aluminium body structure gives exceptional strength whilst also saving weight, giving you more payload.

The BV64e has a floor area of 1.21m x 1.98m with an internal volume of 2.3m³, and a maximum gross weight of 500kg.

1. Refer to towing vehicle manufacturers handbook for maximum unbraked towing limit.
2. If fitted with optional Quad Bike drawbar.



P7e ramp model with optional propstands



BV64e roller shutter model



P8e



The Q Range are engineered for professional use and are built to last. They come in rugged sizes from 1.5m x 1m (5' x 3') to 2.5m x 1.45m (8' x 4'9").

With its high sides and range of accessories the Q Range is an exceptionally versatile trailer. While the Q trailer is ideal for many farming applications, it is also ideal for other industries such as building, landscaping and forestry.

Q5e Off Road/Road

This is a compact and robust trailer which comes in two variants: off road only versions and a dual version suitable for both road and off road. The trailer is available with either mesh or solid hinged sides as well as stock ramp and propstands.

The off-road trailer comes without lights or mudguards— meaning it is specifically for off-road use and makes the trailer less expensive and lighter than its road alternative.

The Q5 has a bed size of 1.5m x 1m (5' x 3'3") and is available in either 750kg or 350kg gross weight. There are two options for tyres on the off-road Q5e trailer – either the flotation tyres (20.5 x 8-10) or the knobbly tyres (22 x 11-8). The latter have a very deep tread depth which helps the trailer stay on track behind the towing vehicle in muddy conditions or hilly terrain.

Q6 & Q7 Off Road

The Q6 and Q7 have a bed width of 1.22m (4') and bed lengths of 1.95m (6'4") and 2.19m (7'2"), with 750kg GVW. This means they are solely for off-road use and come with a range of additional accessories and options.

Both the Q6 and Q7 have the options of hinged mesh sides or hinged solid sides as well as a roof and rack, stock ramp with stock door or simply a ramp. The roof and rack* is ideal for carrying feed or fencing posts when animals or other items are inside. A cross division option is also available which has an integrated door for internal access.

*The roof and rack has a maximum recommended weight of 50kg and uses two fasteners which are easily removed.

Q6, 7 & 8 Road

The Q6 and Q7 have a bed width of 1.22m (4') and bed lengths of 1.95m (6'4") and 2.19m (7'2"). The Q8 has a bed width of 1.45m (4'10") and a bed length of 2.51m (8'). All braked versions have a GVW of 1000kg whilst the unbraked trailers have a GVW of 750kg.

The roof and rack option is helpful for keeping contents dry as well as being able to carry fencing posts or a whole range of other materials*. The numerous tie down points on the roof and rack allow any load to be secured at any point along.

*The roof and rack has a maximum recommended weight of 50kg and uses two fasteners which are easily removed.



Q6e off road with internal partition and hinged solid sides.



Q7b with solid sides, roof and rack

TRAILER IDENTIFICATION PLATES – FOR TRAILERS PRODUCED SINCE SEPTEMBER 2012

Your trailer will have two or three identification plates which are typically attached to the right hand side of the drawbar. These plates contain important information including the trailers serial number (also known as VIN number) and its max gross weight.

For trailers produced on or before Sept 2012, there will still be a VIN Plate, which carries the serial number in the same format as the new trailers. (There may not however be a Drawbar approval plate fitted)

STANDARD EC APPROVAL VIN PLATE

1	EC approval number	1
	VIN Number	2
	Gross vehicle weight	3
	Permissible mass on a single axle	4
	Permissible mass on a double axle	5
	Permissible mass on a triple axle	6
	Internal description	7

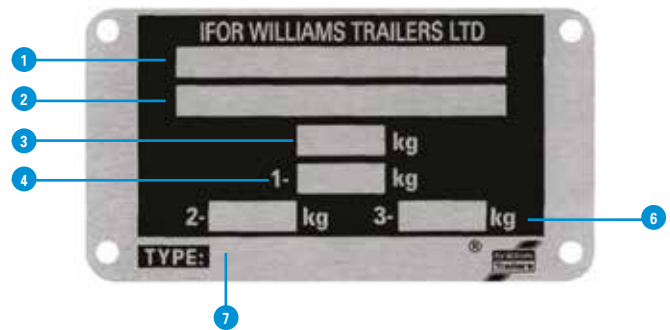

DRAWBAR APPROVAL PLATE

2	Trailer manufacturer	1
	Trailer model	2
	Drawbar variant code	3
	Maximum gross weight that can be fitted to this model of drawbar	4
	Theoretical horizontal reference force	5
	Max static load	6
	EC approval number	7

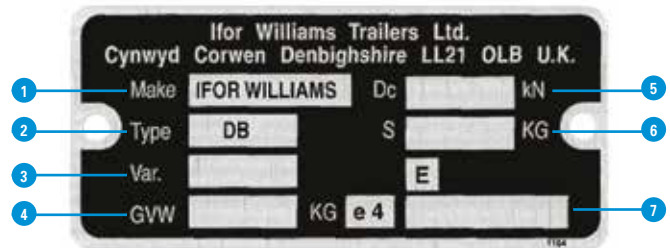

DOWN RATED TRAILER WEIGHT VIN PLATE

(Occasionally trailers are down rated (normally if the driver has not got B1 and E towing entitlements. If it has been downrated this plate will be present.)

3	EC down-rated approval number - Country specific	1
	VIN Number	2
	Gross vehicle weight	3
	Permissible mass on axle 1	4
	Permissible mass on axle 2	5
	Internal description	6

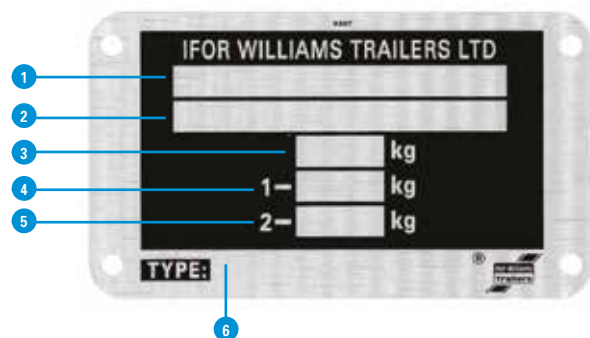

SERIAL NUMBER OF YOUR TRAILER

When ordering certain types of spare parts you will need to supply us with the serial number of the trailer. This identifies the age and batch reference of the trailer, which informs us of any changes to product specification around the date of manufacture. If you are ordering spares for more than one trailer, you will need to identify which serial number the parts are intended for.

HOW TO FIND YOUR SERIAL NUMBER

Every trailer we manufacture is fitted with a type plate (plate 2 – Standard EC approval VIN plate), this will have a unique serial number printed on it by multi-dot punching. An example of a standard type plate is shown opposite. All Ifor Williams Trailers serial numbers begin with the prefix SCK. This example is printed with the full 17 digit VIN (Vehicle Identification Number). The last 6 or 7 digits represent the serial number depending on the age and model of your trailer. Some models may be fitted with a slightly smaller plate; however, the serial number will still be present and easily recognisable.

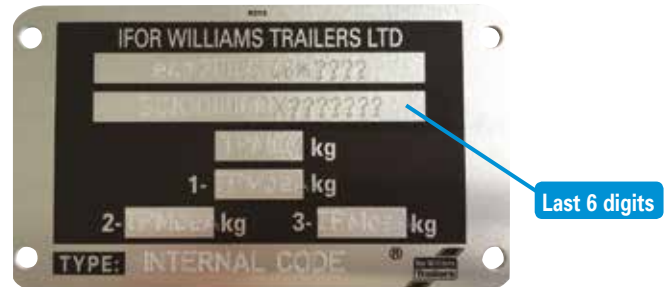

BRAKED TRAILERS

For trailers with 'A Frame' drawbars the plate is located on the outside of the right hand drawbar member. On trailers with adjustable height couplings the plate is located on the right hand section of the supporting structure that the drawbar/coupling unit is clamped to.

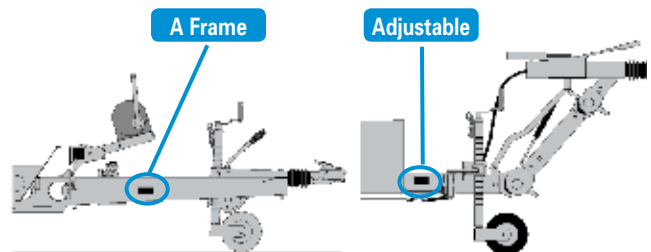

UNBRAKED TRAILERS

On P5/6/7e/8e (unbraked) models the plate is fitted to the front panel of the trailer, or is sometimes attached to the drawbar mounting bracket. On BV64e boxvan models the plate is fitted to the right hand side of the rear cross member.

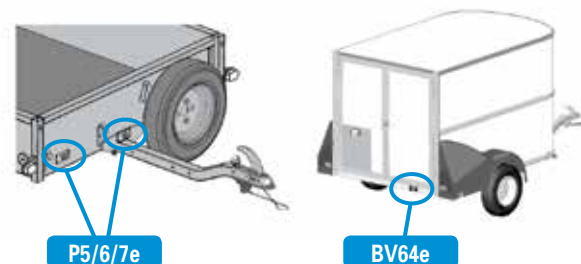

HB403 – SINGLE HORSEBOX

Unlike all other horsebox models, the HB403 has its plates fitted to the outer face on the right hand side directly below the front ramp.

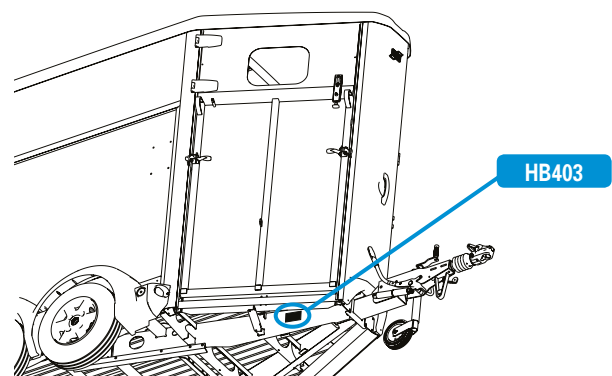

IDENTIFYING COUPLING TYPES

The coupling units fitted to your Ifor Williams trailer may be from one of several different manufacturers, when ordering spares for a coupling or brake linkage it is important to identify the manufacturer and model. Typically an overrun (brake control) coupling unit will be fitted with its own type plate, usually on the top or side of the main shaft housing. The example shown here is from Knott KF13 overrun coupling.

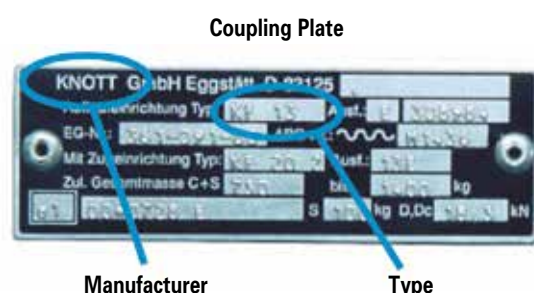

Collection & Gift Ideas

Trailer Covers • Casual Wear • Trailer Cam • Gift Idea's



Umbrella Page 29

Gift Ideas Page 29

Trailer Camera Page 27 - 28

Contents

Page

Trailer Covers

25

Casual Wear

26

Trailer Camera

27 - 28

Gift Ideas

29





TRAILER COVERS & TRAVEL ACCESSORIES

The IWT Collection has been created to offer a selection of additional accessories for our horsebox and trailer customers. Items range from security and safety products to rider clothing, which are all designed to complement our horsebox range.

TRAILER COVERS

The covers are made using a specially manufactured 3 layer heat bonded material designed to be 100% waterproof and breathable. The Torrent fabric prevents water penetrating through the cover in severe weather conditions and allows any condensation that forms under the cover to dry naturally throughout the day.

The cover incorporates a velcro sealed inspection door access available for both left and right hand models, a detachable A frame and coupling cover and webbing straps with buckles keep the cover secured in stormy conditions. Also supplied are poles for lifting cover when fitting, a storage bag and fitting instructions.

Trailer Aid. Used when replacing a flat or punctured tyre. Saves time and energy no need to use a jack. Available in black and yellow.

- B0054** Black.
- B0055** Yellow.



- B01686L** Trailer Cover HB403 / HB401. For models with a left hand side inspection door. Blue
- B01686R** Trailer Cover HB403 / HB401. For models with a right hand side inspection door. Blue
- B01696L** Trailer Cover HB506 / HB505. For models with a left hand side inspection door. Blue
- B01696R** Trailer Cover HB506 / HB505. For models with a right hand side inspection door. Blue
- B01706L** Trailer Cover HB510 / HB511. For models with a left hand side inspection door. Blue
- B01706R** Trailer Cover HB510 / HB511. For models with a right hand side inspection door. Blue
- B01740L** Trailer Cover Eventa L. Blue
- B01704M** Trailer Cover Eventa M. Blue

POLO SHIRT

1 100% Cotton, short sleeved. Available in navy or white.

Size	Part Number (Navy)	Part Number (White)
S	B0178S	B0179S
M	B0178M	B0179M
L	B0178L	B0179L
XL	B0178XL	B0179XL

FLEECE

2 Wind proof fleece 100% polyester. Available in navy.

Size	Part Number (Navy)
S	B0180S
M	B0180M
L	B0180L
XL	B0180XL

BODY WARMER

3 Reversible fleece lined body warmer. Available in two colours.

Size	Part Number (Navy/Camel)	Part Number (Royal/Navy)
S	B0181S	B0182S
M	B0181M	B0182M
L	B0181L	B0182L
XL	B0181XL	B0182XL

HI-VISIBILITY RIDER VEST

4 Available in pink or yellow.

Size	Part Number (Pink)	Part Number (Yellow)
S	B0176S	
M	B0176M	B0177M
L	B0176L	B0177L





IWT HORSE & TRAILER DIGITAL CAMERA

B0230 Trailer Cam. Includes Wireless digital wide angled camera with night vision, 5" LCD Monitor, monitor holder and power cables. Powered as standard from the trailer lighting system with the option of purchasing a battery pack for powering with more flexibility.

Transmits interference free live colour footage from the trailer to the towing vehicle enabling passengers to monitor animals during transit.

Trailer Cam is also proving popular for a variety of other uses as well as trailer interiors, it can also be used in stables, livestock sheds and dog kennels.

A Free line of sight range between the camera and monitor of up to 150 metres – please check the signal quality before mounting Permanently.

Night vision of up to 5 metres. Can be used as a reversing aid (with the purchase of an additional camera)

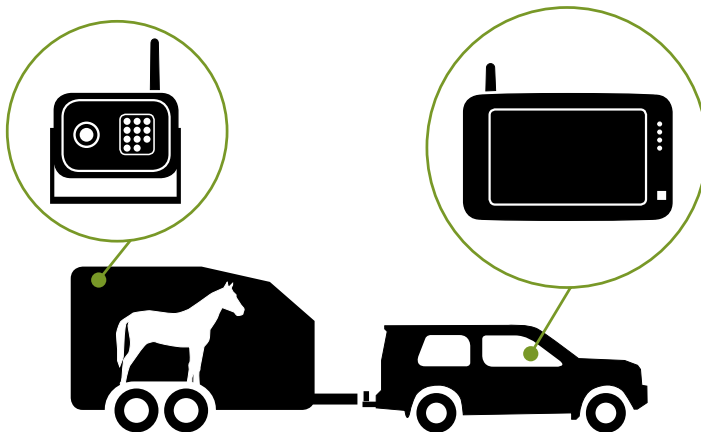



- 1 B0230BAT Water proof Battery and Magnet Flexi Pack.**
Rechargeable with a running time of 10 – 15 hours. Can be used to power the Trailer Cam, giving added flexibility to use the camera system with multi vehicles or in an environment without an electrical supply.
- 2 B0230CAM Additional / Spare Digital Camera.** Can be fitted in addition to the camera supplied with the Trailer Cam system or fitted to the exterior of the trailer as a reversing aid.
- 3 B0230HOL Replacement Monitor Holder.**
- 4 B0230MON Replacement Monitor.**





1



2



3



4



6



7



5



8



9

- 1 B0060S Adult Tee Shirt. 100% cotton Sizes: S.
- B0060M Adult Tee Shirt. 100% cotton Sizes: M.
- B0060L Adult Tee Shirt. 100% cotton Sizes: L.
- B0060XL Adult Tee Shirt. 100% cotton Sizes: XL.
- 2 B0056 Umbrella. Large golfing style umbrella.
- 3 B0159 Note Block. 100mm square telephone jotter pad.
- 4 B0158 Mug. Ceramic Ifor Williams Trailers branded mug.
- 5 B0068 Pen. Ifor Williams Trailers ball-point pen with soft grip.
- 6 B0066 Baseball Cap. One size fits all.
- 7 B0191 Toy TA510G Tri-axle. 1/32 scale, 2 cows included.
- 8 B0192 Toy HB506. Britains farm toys 1/32 scale HB506 Horsebox trailer.
- 9 B0193 Toy TA510G 14 Tri-axle. Britains farm toys.

Design and shading of product may vary from illustration



Knott Brakes Page 31 - 32

Brakes

Brake Shoes • Brake Assemblies • Rods, Cables & Adjusters

Contents

Page

Knott Brakes 200x50 (8"), Brake Assemblies, Spare Shoes, Springs and Spares	31
Knott Brakes 250x40 (10"), Brake Assemblies, Spare Shoes, Springs and Spares	32
Al-Ko Brakes (all sizes), Brake Assemblies, Spare Shoes, Springs and Spares	33
Bowden Cables, Brake Rods, Compensators and Spherical Adjusting Nuts	34
Bowden Cables – Quick Reference Guide	35

200 x 50 BRAKE ASSEMBLY (8")

Used since September 1992 on the following models BV4 & 5, CT115, CT136SA, & CT136, Eurolight Range, GD4 & GD5 Range, GD6 (165R13 Wheels), GH64, GH94 & GH94BT, GX84, GX85 & GX105, Horsebox range, LT range, LM85G, LM105G & LM125G, TA5G 8', 10' & 12', All Tri axle models. TB range with 10" wheels, TT2515, P6B, P7B, P8B, Q6B, Q7B & Q8B



P000120A Brake assembly. 200 x 50 (45mm diameter central hole) RH & LH - weld on type backplates pre-assembled with shoes, springs etc. Fitted from Sept 92 - Jan 94. Distributor supply & fit only

P000120B Brake assembly. 200 x 50 (45mm diameter central hole) RH & LH - weld on type backplates pre-assembled with shoes, springs etc. Fitted from Sept 92 - Jan 94. Distributor supply & fit only

P000140 Brake assembly. 200 x 50 RH & LH - Bolt on type backplates pre-assembled with shoes, springs etc (From Jan 1996).

F0940S Setscrew M12. Fixes 200 x 50 backplate to axle stub (4 per side).

P00051 Steady spring. 200 x 50 brake, holds the shoe against the backplate (fixed shoe only).

P00050 Brake spring. 200 x 50 brake, fits between shoes at adjuster end (87mm long).

P00049 Brake spring. Fits between the shoes at the expander end (75mm long).

P00048 Carrier spring. Holds the sliding shoe onto the carrier (2 off per wheel).

P00038 Re-adjustment Wedge. Fitted immediately behind the adjuster bolt this acts on the adjuster posts to adjust the brakes

P00042 Adjuster post. 200 x 50 brake, fitted each side of the adjuster screw (2 required per brake).

P00037 Eyelet. Connects the brake cable to the expander assembly.

P00036 Expander. Fits between the brake shoes (same expander for left or right).

P00044 Half shell. Shell for cable entry to backplate.

P00045 Inspection plug. 200 x 50 - covers the hole that allows brake lining inspection.

P00040 Adjuster Bolt. M10 40mm long hexagonal headed High Tensile bolt.



P000320 Brake shoe set. 200 x 50 (8")

A full set comprising two fixed and two sliding brake shoes, auto-reverse sliding shoe carrier and all springs required to complete the installation.

This kit services one axle, for continued safety, brakes should always be changed as complete axle sets.

**COMPLETE
AXLE SET**



**Used since
September
1992**



250 x 40

BRAKE ASSEMBLY (10")

Used since September 1992 on the following twin axle models BIAB, BV6 range, CT136HD, CT166G, CT167G, CT177, DP120G, Eventa, GD1*6GM, GH1054, GP6, GP7, GX105HD, GX106, GX126, HB510XL, HB610, LM105GHD, LM85HD, LM6G/GB, LM7G, TA5GHD, TA510G, Transporta, TT105G, TT3017, TT126G, TT3621, TB range with 12" wheels



1 P000160 Brake assembly. 250 x 40 RH & LH - Bolt on type backplates pre-assembled with shoes, springs etc (From Jan 1996 - March 2014). Unequally spaced holes in a rectangular pattern.

2 P000271 Brake Assembly. 250 x 40 RH & LH. Bolt on type backplates pre-assembled with shoes, springs etc (from March 2014). Equally spaced holes in a square pattern.

4 F0941S Setscrew M14. Cap head screw for fixing the brake backplate to the stub axle.

5 P00054 Steady spring. 250 x 40 brake, holds the shoe against the backplate (fixed shoe only).

6 P00052 Brake spring. For 250 x 40 brake fits between shoes at expander end. Silver coloured spring.

7 P00053 Brake spring. For 250 x 40 brake fits between shoes at adjuster end. Black coloured spring.

8 P00048 Carrier spring. Holds the sliding shoe onto the carrier (2 off per wheel).

9 P00039 Re-adjustment wedge. Fitted immediately behind the adjuster bolt this acts on the wedges to adjust the shoes.

10 P00043 Adjuster post. 250 x 40 brake, fitted each side of the adjuster screw (2 required per brake).

11 P00037 Eyelet. Connects the brake cable to the expander assembly.

12 P00036 Expander. Fits between the brake shoes (same expander for left or right).

13 P00044 Half shell. Shell for cable entry to backplate.

14 P00046 Inspection plug. 250 x 40 - covers the hole that allows brake lining inspection.

15 P00041 Adjuster Bolt. M12 40mm long hexagonal headed High Tensile bolt.



3 P000330 Brake shoe set. 250 x 40 (10")

A full set comprising two fixed and two sliding brake shoes, auto-reverse sliding shoe carrier and all springs required to complete the installation.

This kit services one axle, for continued safety, brakes should always be changed as complete axle sets.

COMPLETE AXLE SET



**Used since
September
1992**

Parts for trailers originally fitted with Al-Ko brakes

Al-ko brakes were fitted to all models before September 1992
 These trailers have black hub-caps with the Ifor Williams factory address and 0490 phone number but no logo.

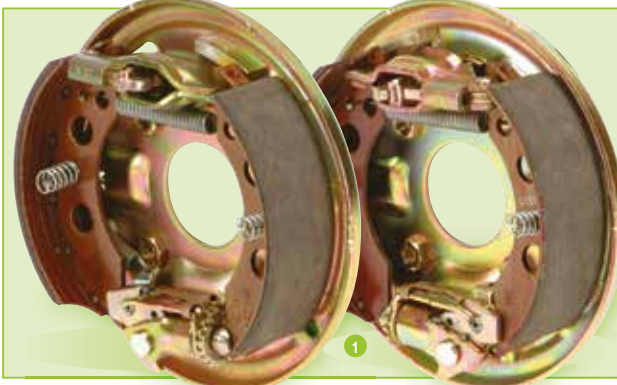

1 P00060 Complete 2050 brake assembly (Axle Set). Pre-fitted to backplate and complete with all springs, adjusters etc.

2 P00130 Complete 2051 brake assembly (axle set). Pre-fitted to backplate and complete with all springs, adjusters etc. Fitted from Jan 1989 – September 1992.

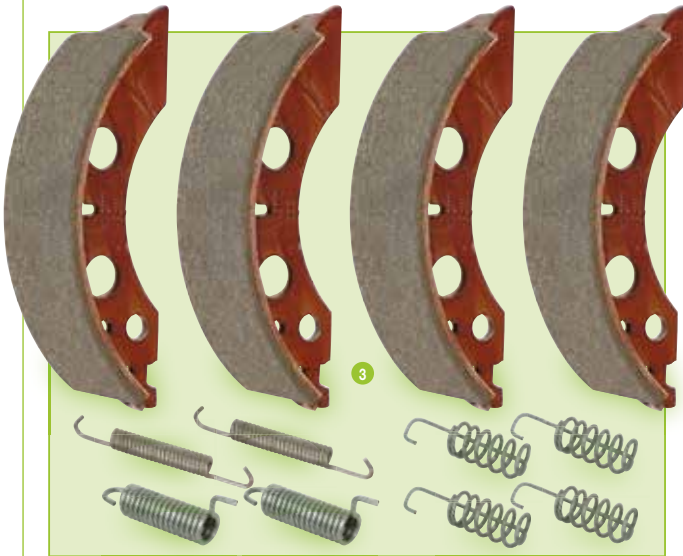

3 P00860 Brake shoe set. 2051 brake (will also fit 2050 brake).

A full set comprising of four brake shoes and all springs required to complete the installation.

This kit services one axle, for continued safety, brakes should always be changed as complete axle sets.

COMPLETE AXLE SET

- 4 P0071 Brake Spring.** 2-1/2" spring fits between brake shoes.
- 5 P0072 Cover Plate.** Used to hold pressure spring (P0073) onto backplate. (2 per brake).
- 6 P0073 Steady Spring.** Holds the shoe to the backplate (2 per brake).
- 7 P0074 Brake Spring.** 1-1/2" spring fits between brake backplate and transmission lever.
- 8 P0085 Expanding Clutch.** For both types of Al-ko brakes replaces older type, however new type brake shoes must be fitted.
- 9 P0078 Adjuster.** Adjuster Screw and nut for Al-Ko type brakes.
- 10 P0079 Cover Cap.** Covers the hole used to access the brake adjuster.
- 11 P0570 Half Shell.** Shell for cable entry on Al-Ko backplates with the quick release system.

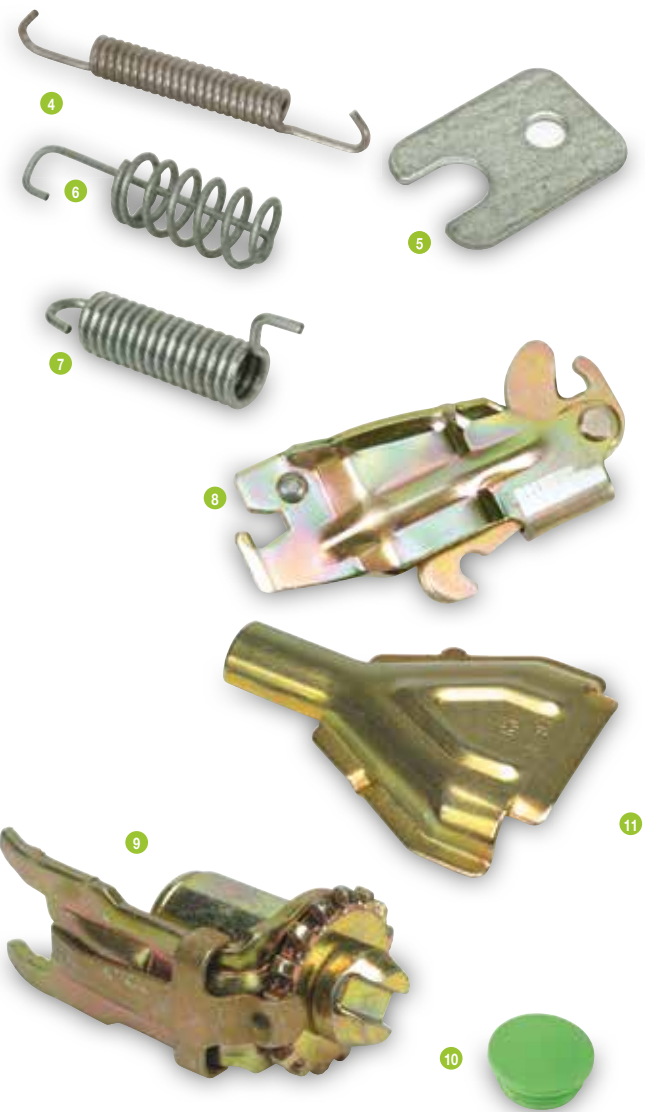

TO ENSURE SMOOTH OPERATION OF THE BRAKES AND TO REDUCE THE POSSIBILITY OF PREMATURE BRAKE WEAR, IT IS RECOMMENDED THAT THE BRAKE CABLES ARE INSPECTED EVERY 5000 MILES OR 12 MONTHS (THIS COULD BE DONE AT THE SAME TIME AS THE BRAKES ARE CHECKED). DAMAGED OR WORN CABLES SHOULD BE REPLACED IMMEDIATELY

TYPE 1 CABLE

With small cast end fitting for Lockheed & Al-ko brakes. Used on trailers manufactured before January 1989.

		Inner	Outer
1	P0109	1300	1000
	P0110	1400	1100
	P0111	1500	1200
	P0107	1705	1430
	P0123	1875	1600

TYPE 2 CABLE

With 26mm tubular end fitting for Alko brakes. Used from Jan 1989-Sept 1992

2	P0132	980	770
	P0133	1100	890
	P0135	1340	1140
	P0137	1640	1430
	P0138	1830	1620
	P0139	2220	1990

TYPE 3 CABLE

With 22mm tubular end fitting for Knott brakes. Used on trailers manufactured after September 1992

	P01401	840	630
	P0140	980	770
	P0141	1110	900
3	P0142	1340	1130
	P0143	1640	1430
	P0144	1840	1630
	P0145	2200	1990
	P0146	2000	1790
	P0147	2340	2130
	P0148	2560	2350
	P0149	2960	2750

4	C00023	Drawbar Spreader Plate.
5	C10801	Balance bar. Simple compensator used on single axle trailers.
6	C10800	Compensator beam. Used on twin axle trailers
7	C10111	Tri Axle 3-way Compensator.
8	C10799	Rocker. Two of these are fitted to the compensator beam on twin axle.
9	C10802	Tri Axle Compensator.
10	C10803	Tri Axle Compensator Bracket.
11	F1090Z	M10 Spherical seat nut. M10 used at the compensator end of the brake rod.
12	F1091Z	M8 Spherical nut. M8 used at the compensator end of the brake cables.
13	F1171	Spherical Washer M10. Replaces F1090Z on the tri axle brake assemblies.
	F1172	Spherical Washer M8. Replaces F1091Z on the tri axle brake assemblies.

MAIN BRAKE RODS

14	P05001	Brake Rod. 1270mm
	P05003	Brake Rod. 1675mm
	P05005	Brake Rod. 1970mm
	P05006	Brake Rod. 2030mm
	P05008	Brake Rod. 2210mm
	P05011	Brake Rod. 1300mm
	P05012	Brake Rod. 1330mm
	P05014	Brake Rod. 1475mm
	P05017	Brake Rod. 1370mm
	P05021	Brake Rod. 1510mm
	P05022	Brake Rod. 1725mm
	P05023	Brake Rod. 2475mm
	P05025	Brake Rod. 2060mm
	P05026	Brake Rod. 1935mm
	P05028	Brake Rod. 1785mm
	P05031	Brake Rod. 1570mm
	P05032	Brake Rod. 1460mm
	P05035	Brake Rod. 1130mm
	P05037	Brake Rod. 1010mm
	P05038	Brake Rod. 965mm
	P05039	Brake Rod. 2260mm



FOR TRAILERS USING TYPE 3 CABLES, FROM SEPT 92 ONWARDS

Brakes

Type	Model	Front Axle	Rear Axle
Beavertail	LT146GB, LM146GB, LM166GB	P0141	P0144
Beavertail	LM147GB, LM167GB	P0142	P0145
Box Van	BV84 Single Axle	P0141	
Box Van	BG84 Twin Axle	P0141	P0143
Box Van	BV85G Single Axle	P0143	
Box Van	BV85G Twin axle	P0141	P0144
Box Van	BV105G	P0141	P0144
Box Van	BV125G	P0142	P0146
Box Van	BV106G	P0142	P0144
Box Van	BV126G	P0142	P0145
Business in a Box	BIAB M	P0142	P0146
Business in a Box	BIAB L	P0142	P0146
Car Transporter	CT115, CT136SA	P0142	
Car Transporter	CT136, CT136HD	P0142	P0146
Car Transporter	CT177	P0147	P0149
Car Transporter	Covered Car Transporter CCT5221	P0143	P0148
Eurolight	EL071-2012, EL071-2515, EL101-2012	P0141	
Eurolight	EL101-2512, EL141-2512	P0142	
Eurolight	EL142-2512	P0140	P0144
Eurolight	EL142-3015, EL142-3615	P0142	P0144
Eurolight	EX202-2515	P0141	P0144
Eurolight	EX202-3015, EX202-3615	P0142	P0144
Eventa	Medium and Large	P0142	P0146
Flatbed	LM85G, LT85G	P0140	P0143
Flatbed	LM105G, LT105G, LM125G, LT125G, LM106G, LT106G, LM126G, LT126G, LM146G, LT146G, LM166G	P0141	P0144
Flatbed	LM186G	P0141	P0146
Flatbed	LM147G, LM167G	P0142	P0145
Flatbed	LM187G	P0142	P0146
General Duty	GD64G, GD84G	P0141	
General Duty	GD84GTA	P0141	P0143
General Duty	GD85 SA	P0142	
General Duty	GD85G, GD105G	P0141	P0144
General Duty	GD125G, GD106G	P0142	P0144
General Duty	GD126G	P0142	P0146
Horsebox	HB401, HB403	P0141	P0144
Horsebox	HB505, HB506, HB510, HB511	P0142	P0144
Large Horsebox	HB510XL	P0142	P0145
Large Horsebox	HB610	P0142	P0146
Livestock	P6G, P8G	P0141	
Livestock	TA5G 8', TA5G 10'	P0141	P0144
Livestock	TA5GHD 12', TA5GHD 14'	P0142	P0146
Livestock	TA510G 10'	P0142	P0144
Livestock	TA510G 12'	P0142	P0146
Livestock	TA510G 14'	P0142	P0145
Livestock	DP120G 10', DP120G 12'	P0141	P0146

Type	Model	Front Axle	Rear Axle
Plant	GP106	P0142	P0146
Plant	GP126	P0142	P0145
Plant	GP146	P0144	P0147
Plant	GP127	P0142	P0145
Plant	GP147	P0144	P0147
Plant	GX84	P0140	P0143
Plant	GX85, GX105	P0142	P0146
Plant	GX125HD, GX126	P0143	P0147
Plant	GX106	P0142	P0146
Plant	GH64	P0140	
Plant	GH94, GH94BT	P0140	P0143
Plant	GH1054BT	P0141	P0144
PB Range	P6B, P7B	P0140	
PB Range	P8B	P0141	
Q Range	Q6B, Q7B	P0140	
Q Range	Q8B	P0141	
TB Range	TB 4m	P0140	P0143
TB Range	TB 4.6m & 5m	P0140	P0144
Tiltbed Range	CT166G	P0142	P0145
Tiltbed Range	CT167G	P0143	P0147
Tipper Range	TT85G	P0141	P0144
Tipper Range	TT105G	P0142	P0145
Tipper Range	TT126G	P0143	P0147
Tipper Range	TT2515	P0140	P0144
Tipper Range	TT3017	P0142	P0145
Tipper Range	TT3621	P0141	P0144

TRI AXLE MODELS

Type	Model	Front Axle	Middle Axle	Rear Axle
Business in a Box	BIAB L TRI	P0142	P0146	P0146
Eventa	EVENTA L TRI	P0142	P0146	P0148
Flatbed	LM126G/TRI	P0141	P0143	P0145
Flatbed	LM14G/TRI	P0141	P0143	P0145
Flatbed	LM166G/TRI	P0141	P0143	P0145
Flatbed	LM186G/TRI	P0141	P0143	P0146
Flatbed	LM147G/TRI	P0142	P0143	P0147
Flatbed	LM167G/TRI	P0142	P0143	P0147
Flatbed	LM187G/TRI	P0142	P0144	P0147
Livestock	TA510G 14' TRI	P0142	P0143	P0147
Livestock	DP120G 12' TRI	P0142	P0144	P0148
Livestock	DP120G 14' TRI	P0142	P0144	P0148
Plant	GP126 TRI	P0142	P0144	P0148
Plant	GP146 TRI, GP147 TRI	P0143	P0145	P0149
Plant	GX126 TRI	P0142	P0146	P0148
Tiltbed	TB5M & 5.5M TRI	P0140	P0143	P0147



Running Gear & Wheel Equipment

Hubs & Bearings • Axles • Suspension Components • Wheels & Tyres • Mudguards

Contents

	Page
Hubs, Bearings and Components for current models	37
Hubs, Bearings and Components for older models	38
Axle Beams & Complete Assemblies	39
Unbraked Axles & Suspension Components	40
Tyres & Accessories	41
Wheel Assemblies & Wheel Centres	42
Spare Wheel Brackets, Spare Wheel Kits & Spare Wheel Covers	43
Mudguards for older models	44
Mudguards & Rainflaps for current models	45

- 1 **P1258 Hub cap Grey 76mm.** For trailers with bolt on knott brakes and 76mm bearings 1996 onwards. Damaged or missing hub caps should be replaced as soon as possible to avoid potential contamination of the unitised bearing.
- 2 **F1014Z Stake Nut M30.** With flange.
- 3 **F1016 Stake Nut.** Fitted to the Unbraked Eurolight & Q Range.
- 4 **F1951 Circlip.** 76mm internal (bearing retainer) circlip - for the current production type bearing.
- 5 **P00002 Bearing.** Unitized bearing for hubs with a 76mm bore. Fitted since January 1996. This bearing is sealed for life and should not be disassembled.
- 6 **P00003 Bearing.** Fitted to the Unbraked Eurolight & Q Range.

The Unitised wheel bearings do not require adjustment, however if the hubs are removed it is recommended that a new axle end nut is fitted and tightened to a torque of 350Nm/260lb ft. Over-tightening or under-tightening will cause the bearing to fail.



HUB KITS

These hub kits will suit all braked trailers manufactured since January 1996 and originally fitted with the P00002 bearing.

- 7 **KS0825 Hub kit.** 200 x 50, 4 bolt holes. Contains hub as illustrated, P1258 hub cap, F1014Z Stake nut, F1951 Circlip & P00002 Bearing.
- 8 **KS0826 Hub kit.** 200 x 50, 5 bolt holes. Contains hub as illustrated, P1258 hub cap, F1014Z Stake nut, F1951 Circlip & P00002 Bearing.
- 9 **KS0827 Hub kit.** 250 x 40, 5 bolt holes. Contains hub as illustrated, P1258 hub cap, F1014Z Stake nut, F1951 Circlip & P00002 Bearing.
- 10 **KS0828 Bearing Adaptor Kit.** This Kit is required in addition to the relevant hub kit listed above when fitting to a trailer manufactured between September 1992 & January 1996 with the SKF bearing fitted.

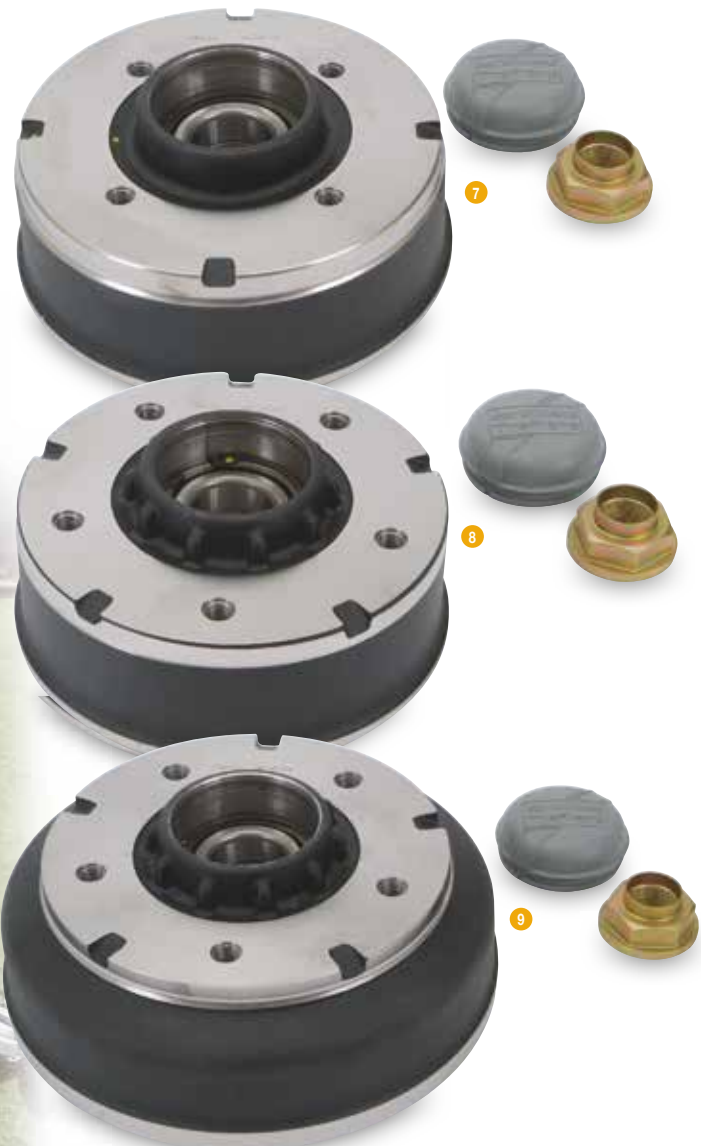

LM146 with headboard, droopsides, mesh sides, ramp and prop stands

Hub kits for trailers manufactured Pre September 1992 with the Alko braking system.

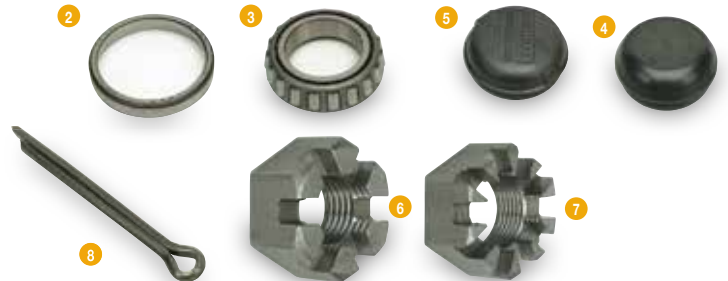

KS0756 Hub Kit. 200mm, 4 stud, smooth cast. Complete with P0001/ P0002 bearings, P0004 oil seal, F1099S axle end nut, C72253 hub cap, 4 x F1801 wheel studs, 4 x F1811 wheel nuts, F1508S split pin, F1909S spiro pin.

F1804 Wheel Stud. M16 x 58mm

F1811 Wheel Nut. M12 x 1.5P

F1813 Wheel Nut. M16 x 1.5P x 19 deep

KS0757L Hub Kit. 200mm, 5 stud, finned cast. Complete with P0001/ P0002 bearings, P0004 oil seal, F1099S axle end nut, C72253 hub cap, 5 x F1804 wheel studs, 5 x F1813 wheel nuts, F1508S split pin, F1909S spiro pin.

C72253 Hub Cap. Plain black. Will fit all braked trailers manufactured up to September 1992

P1250 Hub Cap. Black with IWT logo, 75mm. Fitted to braked trailers from September 1992 to January 1996.

P0001 Bearing Cup. Used on all braked trailers up to September 1992. Requires P0002 bearing cone, 2 per wheel.

F1098S Slotted Nut. 3/4" BSF 6 slot.

F1099S Slotted Nut 3/4" UNF 10 slot.

P0002 Bearing Cone. Used on all braked trailers up to September 1992. Requires P0001 bearing cup, 2 per wheel.

F1508S Split Pin. 5/32" x 1-1/2"

P0003 Oil Seal. 43mm x 75mm x 10mm.

P0004 Oil Seal. 55mm x 75mm x 10mm.

F1801 Wheel Stud. M12



HB511



- Applies to all axles

Axles compatible with 200 x 50 Backplates - 4 & 5 Bolt

Complete Axle Assy Number	Models This Axle Is Compatible With	Axle Beam	Length of Spring Centes	Length Over Hub Faces	Number of Wheel Bolts
AS4007	Unbraked Eurolight		757	1122	4
AS6401	GD6, HB510, HB511	AS0381	1770	2110	4
AS6402	HB505, HB506	AS0382	1642	1984	4
AS6403	TA5G, GD5	AS0383	1542	1924	4
AS6404	LT6G, GB	AS0384	1450	1828	4
AS6406	HB401	AS0386	1227	1610	4
AS6407	LT1*5G	AS0387	1146	1520	4
AS6408	TT85G	AS0388	1110	1460	4
AS6409	LT85G, TT2515	AS0389	1045	1387	4
AS6414	BV5G	AS0390	1530	1924	4
AS6415	P6G, P8G, BV84G	AS0391	1224	1610	4
AS6440	Eventa Tri Axle	AS0392	1755	2100	5
AS6417	GD4, GD84GTA, GX84	AS0393	1250	1610	4
AS6445	GX85, GX105	AS0395	1575	1935	4
AS6451	Eurolight 1.2m	AS0411	757	1147	4
AS6452	Eurolight 1.5m	AS0412	1032	1407	4
AS6458	GH64, GH94, P6B, P7B, Q6B, Q7B	AS0423	1161	1511	4
AS6459	GH94+3, GH94+3BT	AS0340	1240	1590	4
AS6460	HB403	AS0413	1275	1610	4
AS6466	P8B, Q8B	AS0343	1386	1753	4
AS6480	TB 2.1m with 10" wheels	AS0344	1411	1753	4
AS6410	TA5G 10' & 12, GD5 (5 Bolt)	AS0390	1542	1924	5
AS6412	LM105G, LM125G	AS0387	1146	1520	5
AS6413	LM85G, TT2515 with 12" wheels	AS0389	1045	1387	5
AS6418	LM1*6/ DP/ CT166 Tri Axle	AS0384	1450	1828	5
AS6439	CT115	AS0379	1610	1975	5
AS6440	LM1*7/ CT167 Tri Axle	AS0392	1755	2100	5
AS6442	GX126 Tri, GP126 & GP146 Tri Axle with 12" wheels	AS0381	1770	2110	5
AS6444	TA510G3 14' Tri Axle	AS0398	1770	2150	5
AS6447	CT136, CT136SA	AS0397	1770	2135	5
AS6448	GP126 & GP146 Tri Axle with 16" wheels	AS0399	1770	2175	5
AS6455	GD4 with 16" wheels	AS0393	1250	1610	5
AS6456	GD5 with 650R16 wheels	AS0395	1575	1935	5

AXLES COMPATIBLE WITH 250 X 40 BACKPLATES – 5 BOLT

In March 2014 the design of the 250 x 40 backplate changed. For trailers manufactured before March 2014 with 250 x 40 Knott backplates, a replacement axle weld assembly is no longer available which suits that design of backplate. Should you require a replacement axle weld assembly, you will need to order a new 'complete axle assembly' which will be supplied with the new style backplates fitted (and hub).

Complete Axle Assy Number	Models This Axle Is Compatible With	Axle Beam after March 2014	Length of Spring Centes	Length Over Hub Faces	Number of Wheel Bolts
AS6420	BV6 with 16" wheels, HB510XL & HB610	AS029504	1770	2150	5
AS6421	BV6 with 12" wheels, GP1#6 with 12" wheels, GX106, GX106N & GX126	AS029505	1770	2110	5
AS6422	DP Range, LM6G & B Range, CT166, TT3621	AS029506	1450	1828	5
AS6424	LM105GHD, LM125GHD, TT105G, TT3017	AS029508	1146	1520	5
AS6425	LM85GHD	AS029509	1045	1387	5
AS6426	LM147G, LM/CT167G, CT177, EVENTA	AS029510	1755	2100	5
AS6427	TA5GHD	AS029503	1542	1924	5
AS6428	TA510G	AS029511	1770	2175	5
AS6431	GX105HD, GX125HD, GD5 with 175 75 R16 wheels	AS029502	1575	1935	5
AS6461	GH1054	AS029514	1556	1905	5
AS6481	TB 2.1m with 12" wheels	AS029516	1411	1753	5



NEW TYPE

- 1 **P12081 Spring Eye Bush.** Used in parabolic springs Type C90003 & C90004. Fitted up to 2001
- 2 **P1208 Bush.** Used in parabolic springs Type C90001 & C90002. Fitted up to 2001
- 3 **C20340 Spacer Tube.** For spring eye bush in Parabolic springs C90001 and C90002 (will not fit C90003 or C90004).
- 4 **C90003 Parabolic Spring.** Mono leaf parabolic road spring (current production type).*
- 5 **C90004 Parabolic Spring.** Twin leaf parabolic road spring (current production type).*
- 6 **F0417 Centre Bolt.** M8 x 40 Spring centre bolt. Bolts the two leaf spring together.
- 7 **C31270 Clamp Plate.** Used to secure U bolts to axle and springs (2 per axle).
C00131 **U Bolt.** Fitted the Q and the Unbraked Eurolight range of trailers.
- 8 **C00141 U Bolt.** Holds the axle and roadsprings together - 4 per axle 120mm long (single leaf springs).
- 9 **C00148 U Bolt.** Holds the axle and roadsprings together - 4 per axle 130mm long (Two leaf springs).
- 10 **C70340 Spring Retainer Bush.** 50mm Used at the flat end of the mono leaf spring to prevent spring movement (where there is no second spring eye present).
- 11 **C70341 Spring Retainer Bush.** 42mm Used at the flat end of the twin leaf spring to prevent spring movement (where there is no second spring eye present).
- 12 **C80315 Bump Stop.** Used on all trailers with Parabolic springs from January 1994
- 13 **C80316 Bump Stop.** Fitted to the new TB range of trailers, offset centre.
- 14 **C80317 Bump Stop.** Fitted the Q and the Unbraked Eurolight range of trailers.
- 15 **C80318 Rebound Bush Moulding.** Fitted to the Tipper (TT2515, TT3017, TT3621 range) above and below the suspension leaf springs at the tail end of the spring to reduce the noise generated by the suspension
F0374ZPK **Bolt M12 x 80 Hex High Tensile.** Used to secure the leaf spring through the eye of the bush. Pack Qty 10.
F0378ZPK **Bolt M12 x 100 Hex High Tensile.** Used to secure the leaf spring through the eye of the bush. Pack Qty 10.
F1056ZCPK **Nut M12 Flanged Nyloc.** Used to secure the C00141 & C00148 U Bolts. Pack Qty 10. It is recommended that these nuts are checked and tightened every 1000 miles or 2 months. They should be tightened to 140Nm (socket size 18mm)









* It is recommended that these springs are changed in axle sets only.

OLD TYPE

- 16 **P0020 5 Leaf Spring.** This type of roadspring was used on various models until January 1994.
- 17 **P0022 7 Leaf Spring.** This type of roadspring was used on various models until January 1994.
- 18 **C10011 Shackle Bracket.** Weld on component for trailers with 4,5 or 7 leaf springs.
- 19 **C00145 U-Bolt.** Holds the axle and roadsprings together - 4 per axle (7 leaf springs Post March 1990).
- 20 **C00146 U-Bolt.** Holds the axle and roadsprings together - 4 per axle (5 leaf springs Post March 1990).
F1078ZCPK **Nylon Nut 1/2" UNF.** To fit C00145 & C00146 U-Bolts. Pack qty 10
F0464ZPK **Bolt 5/8 unc x 3 3/4 Hex Head.** Used to secure the 5 & 7 leaf spring. Pack Qty 8.
F1081ZPK **Nut 5/8 unc.** Nylon Pack Qty 10.



BV64e, P5, P6e, P7e, P8e, Q5, & Q7 UNBRAKED RANGE

-  **P05915 Suspension Axle.** 500Kg GVW Rubber suspension axle complete with hubs (100mm PCD) as fitted to P5 models.
-  **P05920 Suspension Axle.** 500Kg GVW Rubber suspension axle complete with hubs (100mm PCD) as fitted to P6e & BV64e with 10" tyres.
-  **P05930 Suspension Axle.** 750Kg GVW Rubber suspension axle complete with hubs (100mm PCD) as fitted to P6e & P7e with flotation wheels.
-  **P05940 Suspension Axle.** 500kg GVW Rubber suspension axle complete with hubs (100mm PCD) as fitted to P6e & P7e with 13" wheels.
-  **P05945 Suspension Axle.** 1000kg GVW Rubber suspension axle complete with hubs. (100mm PCD) as fitted to the P8e with 13" and flotation wheels.
-  **AS4002 Axle Weld Assembly.** Fitted to the Q5 Road / Off Road with flotation wheel assemblies.
-  **AS4005 Axle Weld Assembly.** Fitted to the Q6 & Q7 Road /Off Road with flotation wheel assemblies.
-  **AS4009 Axle Weld Assembly.** Fitted to the Q5 Off Road with 22 x 11-8 wheel assemblies.
- P05931 Hub Overhaul Kit.** For the full suspension axle fitted to P6e models (1997 onwards), P5, P7e & P8e overhauls one hub. Complete with bearing, seal, clip, hub cap and axle end nut.
- 25 **P05931/HUB Hub.** For the full suspension axle fitted to P6e models (1997 onwards), P5, P7e & P8e, Unbraked Eurolight & Q range.
- 26 **P05931/BE Bearing.** For the full suspension axle fitted to P6e models (1997 onwards), P5, P7e & P8e.
P00003 **Bearing.** Fitted to the Unbraked Eurolight & Q range.
- 27 **P05931/C Circlip.** For the full suspension axle fitted to P6e models (1997 onwards). Also fitted to P5, P7e & P8e, Unbraked Eurolight & Q range.
- 28 **P05931/S Seal.** For the full suspension axle fitted to P6e models. 56mm OD x 44mm ID x 5mm.
- 29 **P05931/S2 Seal.** For the full suspension axle fitted to P6e models. 64mm OD x 44mm ID x 5mm. Also fitted to P5, P7e & P8e.
- 30 **P05931/AN Axle End Nut.** For the full suspension axle fitted to P6e models (1997 onwards). Also fitted to P5, P7e & P8e.
- 31 **P05931/HC Hub Cap.** For the full suspension axle fitted to P6e models. Fits 52mm hole.
- 32 **P05931/HC2 Hub Cap.** For the full suspension axle fitted to P6e models. Fits 64mm hole. Also fitted to P5, P7e & P8e. Unbraked Eurolight & Q range.





Check the pressure of your trailer tyres before every journey. Under-inflated tyres can cause excessive wear and increased fuel consumption. If severely under-inflated a tyre may overheat and fail. The table below indicates the correct tyre pressures, please be aware that although the total combined tyre max load may exceed the trailer gross weight, the limit outlined on your VIN plate should always be adhered to.



TYRES

Part Code	Size	Load / Speed Index	Max Load Per Tyre (kg)	Pressure Bar	Pressure PSI
1 P0815T	145R10C 8PR	84N / 82N	500	4.5	65
2 P0888T	6.50R16C 10PR	108 107P	1000	5	73
3 P0841T	165R13C 8PR	94N / 92N (96N FRT)	585***	3.4	50
P0841T	165R13C 8PR	94N / 92N (96N FRT)	650***	4.2	60
P0841T	165R13C 8PR	94N / 92N (96N FRT)	710***	4.5	65
P0876T	195/55R10C	98N	750	6.2	90
4 P0878T	155/70R12	104 / 102N	900*	6.5*	94*
P0878T	155/70R12	104 / 102N	900**	6.2**	90**
5 P0875T	185/70R13C	106 / 102N	950	6	87
P0889T	195/60R12	104 / 102N	900	6.5	95
P0879T	175/75R16C	101R (104N) FRT	900	4.8	96

* 5.5 Inch rim
**4.5 Inch rim

***The max load is listed on the side wall of the tyre.

ACCESSORIES

- 6 P08891V **Valve.** Compatible with many wheel assemblies (contact us for details)
- 7 KX0835 **Wheel Trim Set.** To fit 13" wheels, supplied in a set of 4. Style of trim may vary from illustration.
- 8 P1256 **Wheel Brace.** 19mm, supplied as standard with most trailers.
- 9 B0019 **Wheel Wrench.** 4 Headed wrench sizes 17,19,21 & 22mm, supplied with the Horsebox and Box Van prop stand kits.
- 10 F1830ZPK **Wheel Bolt.** M12 x 1.5mm pitch 30mm long, 19mm A/F head. Pack of 4
- 11 F1835ZPK **Wheel Bolt.** M14 x 1.5mm pitch 27mm long, 19mm A/F head. Pack of 5
- 12 KX9802 **Locking Wheel Bolt Kit.** M12 x 1.5 pitch with uniquely coded adapter and spider wheel wrench.
- B0054 **Trailer-Aid Ramp - Black.** Simplifies wheel changing on twin axle trailers.
- 13 B0055 **Trailer-Aid Ramp - Yellow.** Simplifies wheel changing on twin axle trailers.
- 14 KX0240 **Wheel Chocks.** Pair of lightweight wheel chocks with snap fit holder for fixing to trailer.



WHEEL ASSEMBLIES

Part Code	Description	Load / Speed Index	Pressure Bar	Pressure PSI
1 P0815	Wheel Assembly 145R10 8Pr	84N 82N	4.5	65
P0835	Wheel Assembly 145/80B10	74N	2.5	36
4 P0845	Wheel Assembly 145R10/HG58S	325kg @ 190km/h		40
P0877	Wheel Assembly 155/70R12	104/102N	6.5	94
7 P0878	Wheel Assembly 155/70R12	104/102N	6.2	90
8 P0875	Wheel Assembly 185/60R12	104/102N	6.5	94
9 P0876	Wheel Assembly 195/55R10C	98N	6.2	90
10 P08891	Wheel Assembly 195/60R12	104/102N	6.5	95
11 P08891AL	Alloy Wheel Assembly 195/60R12	104/102N	6.5	95
P0833	Wheel Assembly 145/70R13 4PR	84N FRT	3.7	54
P0834	Wheel Assembly 145/70R13 4PR	78N	3.2	47
P0852	Wheel Assembly 155R13 4PR	79S / T / 78S	2.4	35
13 P0841	Wheel Assembly 165R13C 8PR	94N / 92N (96N FRT)	4.5	65
15 P0841AL	Alloy Wheel Assembly 165R13C 8PR	94N / 92N (96N FRT)	4.5	65
P0851	Wheel Assembly 185/70R13C	106 / 102 N	6	87
17 P0872	Wheel Assembly 195/50R13	104 / 102J (100/98N)	6.5	94
18 P0867	Wheel Assembly 20.5 x 8-10 4PR	77M	2.5	36
20 P0868	Wheel Assembly Flotation mounted onto 100mm PCD	600kg @ 130km/h		70
P0879	Wheel Assembly 175/75R16C	101R (104N FRT)	4.8	96
23 P0888	Wheel Assembly 6.50R16C 10PR	108 / 107P	5	73
25 P0894	Wheel Assembly 22 x 11 Off Road Knobbly ATV Tyre	155kg @ 100km/h	0.3	5

WHEEL CENTRES

Part Code	Description	Where Used
2 P0804	Wheel Centre 3.50BX10 ST4/5.5/95 ETO	Older LT models
3 P0864	Wheel Centre 3.5BX10 ST 4/100/60 SILVER	P5, P6e, BV64e & Unbraked Eurolight
5 P0810	Wheel Centre 3.5 x 10	Older P6e trailers with suspension units
6 P0875C	Wheel Centre 5.5JX12 5/6.5/114.5 ETO	CT115, CT136 & CT177
P0878C	Wheel Centre 4.5JX12 5/6.5/114.5 ETO	BV6, GP & GX
6 P0875C	Wheel Centre 5.5JX12 5/6.5/114.5 ETO	Older models
P0876C	Wheel Centre 6.00X10 4/5.5/95.3 ET-10	GH94 (flatbed model) and TB Tiltbed (3T twin axle and tri axle models)
P08891C	Wheel Centre 6JX12 5/6.5/114.5 ETO	BIAB, BV6 series, CT166/7, DP range, Eventa, GP, LM Flatbed and Beavertail range and TB range (longer twin axle models) and Tipper range
12 P08891ALC	Alloy Wheel Centre	Optional accessory on BIAB, Eventa (Style may vary from illustration)
Not Available		LT Range, P#B & Eurolight
Not Available		P6e, P7e & P8e
Not Available		HB401.
14 P0805	Wheel Centre 4.5JX13 4/5.5/95.5 ET25.4	Boxvan (BV4 and 5 series), Eurolight (EL141 and EX202 models), GD range, GX84 and 5, Horsebox range, P*G range, TA5G range
Not Available		Optional accessory on Horsebox range
16 P0820	Wheel Centre 6JX13 H2 5/6.5/114.5 ET+7	GH1054 and Tipper range (TT3017 and TT3621)
16 P0820	Wheel Centre 6JX13 H2 5/6.5/114.5 ET+7	Older models
19 P0865	Wheel Centre 6.00IX10 4/100/60 ET-3	EL071, P6, P7 & Q#e
21 P0812	Wheel Centre 6.00 x 10	Older P6e trailers with suspension units
22 P0808S	Wheel Centre 500F x 16" Vented	BV6, GD, HB510XL, HB610, TA5G & TA510G
24 P0808	Wheel Centre 500F x 16" Non Vented	BV6, GD, HB510XL, HB610, TA5G & TA510G
Not Available		Q5e Off road model



SPARE WHEEL BRACKETS

- 1 AS0013 **Spare Wheel Bracket.** Fitted to the older Livestock and BV trailers and the current GP Low sided range with 12" & 16" wheels.
- 2 AS4520 **Spare Wheel Bracket.** Fitted to the BV64E.
- 3 AS5100 **Spare Wheel Bracket.** Fitted to the Imperial GD range, TT105G, TT126G, P6G & P8G.
- 4 AS5106 **Spare Wheel Bracket.** Fitted to the P5e,P6e,P7e,P8e,P6b,P7b & P8b with 10", 13" & flotation wheel assemblies
- 5 AS5539 **Offset Spare Wheel Bracket.** Can be fitted to the flatbed range when a winch is fitted over the standard spare wheel bracket.
- 6 AS7001 **Spare Wheel Bracket.** Fitted to the current TB range with 10" wheels.
- 7 AS7028 **Spare Wheel Bracket.** Fitted to the current TB range with 12" wheels.
- 8 C00371 **Spare Wheel Bracket.** Fitted to the GX84.
C00215 **Spare Wheel Support J Bolt.** Compatible with the C00371 & C00373 spare wheel brackets.
C00373 **Spare Wheel Support Bracket.** Fitted to the GX105HD & GX6 range with 12" wheels.
- 9 C10769 **Spare Wheel Bracket.** Fitted to the current BV range.
- 10 C10770 **Spare Wheel Bracket.** Fitted to the current Tipper, GD, TA5G & TA510G range. Please specify size of wheel fitted when ordering.
- 11 C12766 **Spare Wheel Bracket.** Fitted to the Eurolight range.
- 12 KX9978 **Spare Wheel Bracket.** Fitted to the HB401, HB505 & HB510.

SPARE WHEEL BRACKET FITTINGS

- 13 C09803 **Spare wheel Studding.** M16 x 165mm.
C09804 **Spare wheel Studding.** M16 x 115mm.
- C15841 **Spare wheel Clamp.** Used with the studding to secure the spare wheel.
- F1062PK **Nyloc Nut M16,8.** Compatible with the Studding. Pack Qty 10.
- F1067ZPK **Nut M16 Hex.** Compatible with the studding. Pack Qty 10.
- 14 KX0795 **Lockable Spare Wheel Carrier.** Compatible with the HB403, HB506 & HB511. Allows for a padlock to be fitted (not included)
- 15 P0885-SVR **Spare Wheel Cover.** Rigid silver /grey cover printed with the Ifor Williams logo. Fits the 165R13 wheel. Compatible with the Horsebox range.
- 16 P4084 **Spare Wheel Cover.** Rigid silver /grey cover printed with the Ifor Williams logo. Fits the 195/60R12 wheel. Compatible with the Eventa.

SPARE WHEEL KITS

Wheel assembly, bracket and all fittings included.

- KX0243 **Spare Wheel Kit.** CT115 & CT136
- KX35318 **Spare Wheel Kit.** GH94BT (165R13)
- KX35319 **Spare Wheel Kit.** GH94 (195/55R10TL)
- KX35320 **Spare Wheel Kit.** GH1054BT (185/70R13)
- KX8645-A **Spare Wheel Kit.** Q#e (Off-Road & Flotation). Not applicable for Q5e Off Road trailers with knobby wheels
- KX8645-B **Spare Wheel Kit.** Q#b (195/55R10)

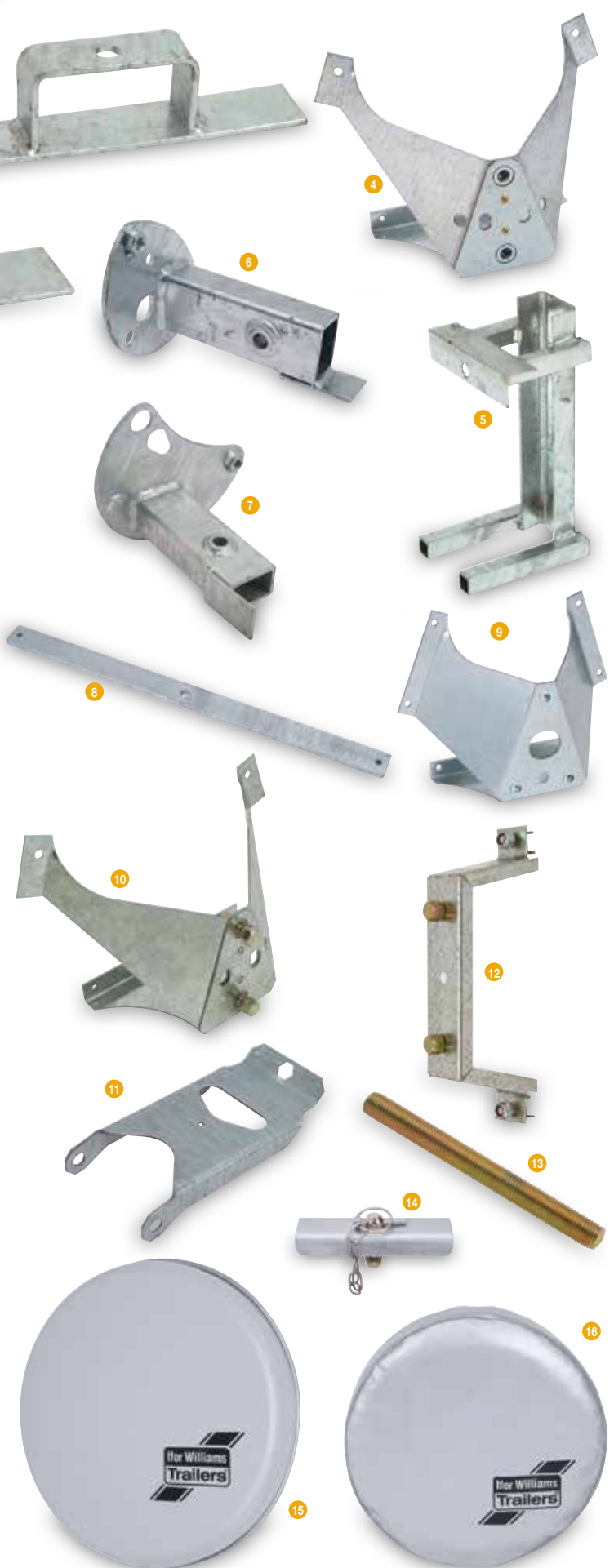

Fitted until
late 2012



- 1 **CP00321 Mudguard Twin Arch Section.** Used on the HB403, HB506 & HB511. Sold individually.
- 2 **CP00322 Mudguard Inner Section.** Used on the HB403, HB506 & HB511. Sold individually.
- 3 **C71730 Mudguard Single.** Used on the CT115, CT136 & CT136SA, P5E & P6E with 10" wheels fitted. (1 pair)
- 4 **C71733 Mudguard Single.** Used on the Eurolight range and The P6E, P7E & P8E with 13" wheels. (1 pair)
- 5 **P0605 Mudguard Single.** Used on the P6E, P7E & P8E with wheels fitted. (1 pair)
- 6 **P0608 Mudguard Single.** Used on the TT126G. (1 pair)
- 7 **P0610 Mudguard Single.** Used on the TA5G 12', TA5G 12' - 4ft h'room, TA510G 12' & TA510G 14', HB510XL 10' GD 4 & 5 with 16" wheels. (1 pair)
- P0613 Mudguard Tandem.** Length 1540mm. Used on the GP 6, TT105G, TA5G 10' & TA5G 10' 4ft h'room, BV106G & BV126G 12" & 13" wheels GD105, GD125, GD106 & GD126. (1 pair)
- P0614 Tandem Mudguard.** Length 1750mm. Used on the TA5G 10' with 16" Wheels & TA510G 10', GD105 & GD125 with 16" wheels, BV106 & BV126 with 16" wheels, HB510XL & HB610. (1 pair)
- P0619 Tandem Mudguard.** Length 1500mm. Used on the HB401, HB505 & HB510. (1 pair)
- P0621 Tri-Axle Mudguard.** Used on the TA510G 14' Tri-Axle. (1 pair)
- 8 **C80370 Mudflap.** For the GH & GP models. Sold individually.
- 9 **C80737 Mudflap.** For the LT/LM/CT models with IWT logo Sold individually.
- 10 **C00473 Mudguard Bracket.** Centre for Tandem mudguards.
- 11 **C00476 Mudguard Bracket.** Front and rear for Tandem Mudguards with 13" wheels fitted.
- 12 **C00477 Mudguard Bracket.** Front and rear for Tandem Mudguards with 16" wheels fitted.
- 13 **C14244 Mudguard Inspection Step.** Fitted between the P0610 mudguards on the older livestock trailers.



Fitted from
late 2012



- 1 **C72710** **Mudguard.** Fitted to the TB range with 10" & 12" wheels. Sold individually.
- 2 **C72711** **Mudguard.** Fitted to the CT115, CT136 & P5e with 10" wheels. Sold individually.
- 3 **C72712** **Mudguard.** Fitted to the Beavertails, Boxvan range with 12" wheels, CT166 & 167, DP range, Eurolight range with 10" & 13" wheels, LT/ LM Range, P6e, P7e, P8e, P6b & P7b. Sold individually.
- 4 **C72713** **Mudguard.** Fitted to the BV range, GD range, P#G and TA5G with 13" wheels. Sold individually.
- 5 **C72715** **Mudguard.** Fitted to the BV, GD, HB510XL, TA5G & TA510G with 175/75R16 wheels. Sold individually.
- 6 **C72716** **Mudguard.** Fitted to the BV, HB510XL, HB610, TA5G & TA510G with 6.50R16 10pr. Sold individually.
- C72583** **Rainflap.** GH64.
- 7 **C72574** **Rainflap.** Fitted to the GP,Q#E & Q#B road range.
- 8 **C72584** **Rainflap.** GH94+3BT & GH1054BT.
- 9 **C72588** **Rainflap.** Fitted to the GH94.
- 10 **C72589** **Intermediate Rainflap.** GH94+3
- 11 **C72614** **Rainflap.** Fitted to the GX4 & 5 range.
- 12 **C72615** **Rainflap.** Fitted to the GX6 range.
- 13 **C12370** **Mudguard Stay.** 21mm offset. Measurement taken from centre of shackle bolt hole to angle of bracket.
- 14 **C12371** **Mudguard Stay.** 27mm offset. Measurement taken from centre of shackle bolt hole to angle of bracket.
- 15 **C12372** **Mudguard Stay.** 47mm offset. Measurement taken from centre of shackle bolt hole to angle of bracket.
- 16 **C12373** **Mudguard Stay.** 75mm offset. Measurement taken from centre of shackle bolt hole to angle of bracket.
- 17 **C12374** **Mudguard Stay.** 96mm offset. Measurement taken from centre of shackle bolt hole to angle of bracket.



Couplings & Trailer Support

Couplings for Braked & Unbraked Trailers • Jockey wheels • Propstands

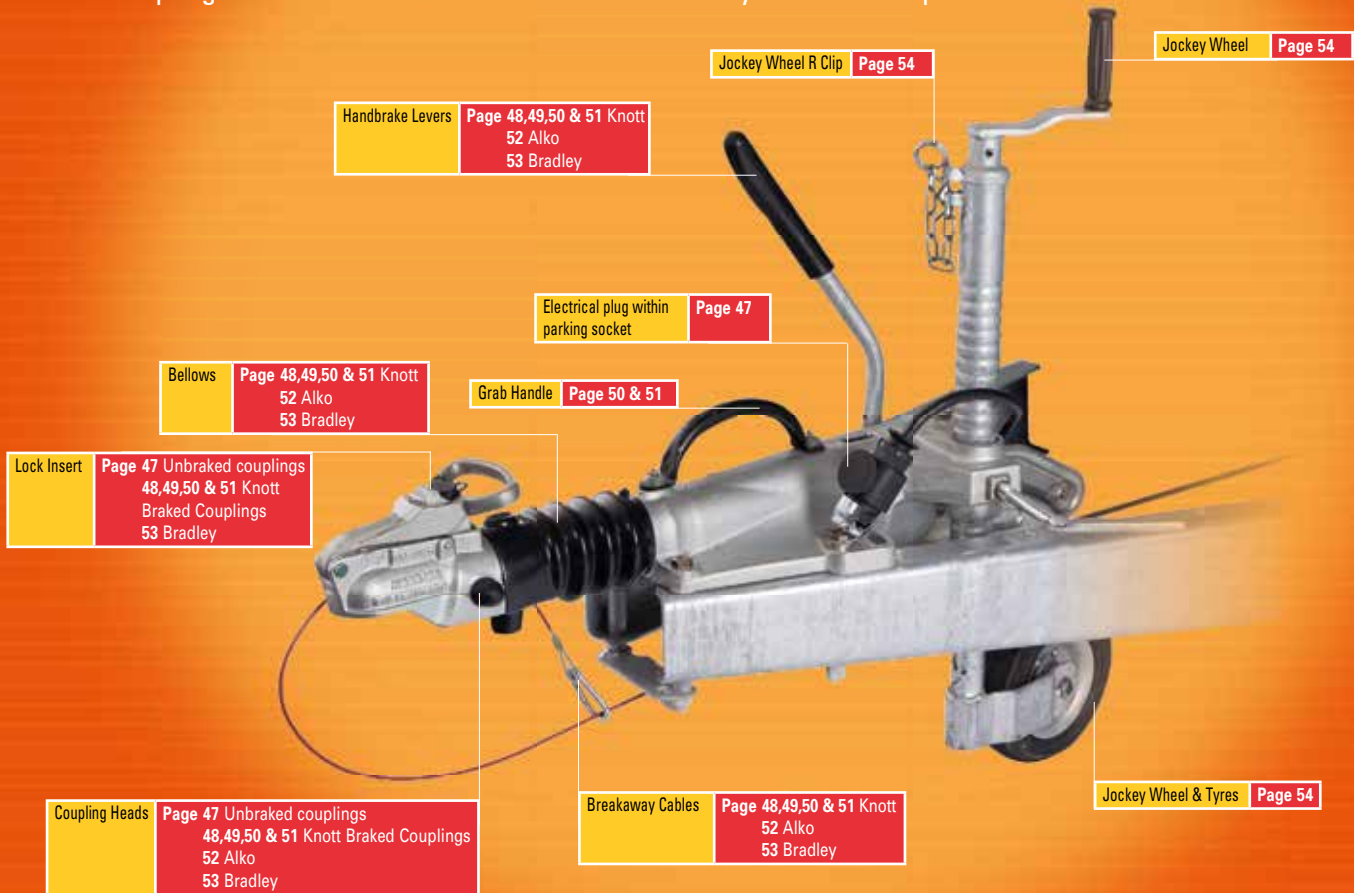

Contents

	Page
Unbraked Couplings & Spares	47
KF13 & KF13E Couplings & Spares	48
KF20, KFG20 & KRV20 Couplings & Spares	49
KFG27 Coupling & Spares	50
KFG35 Coupling & Spares	51
Al-Ko Coupling & Spares	52
Bradley Couplings & Spares	53
Propstands & Jockey Wheels	54
Bolt On Propstands	55

P00280	Unbraked Coupling Assembly KZE 7.5 110 – 120MM centres. Used on the Q#e and unbraked Eurolight range.
P00355LDB	Coupling/Drawbar. Swan neck style drawbar and coupling head. Used on the P5 Range.
P00355DB	Coupling/Drawbar. Swan neck style drawbar and coupling head used on the BV64e & P6e Range.
P00355DB2	Coupling/Drawbar. Swan neck style drawbar and coupling head used on the P7e Range.
P00355DB3	Coupling/Drawbar. Swan neck style drawbar and coupling head used on the P8e
P00355DBQ	Coupling/Drawbar. Used on the Q5e Road.
C24431	Straight Drawbar. Q5e Off Road. Coupling head not included.
1 P00355	Coupling Head. 750kg 50mm ball, pressed steel head. Used on all unbraked trailers.
2 P00270	Swivel Hitch. Used on the Q5e Off Road. Not approved for on-road use.
3 P0150	Coupling Head. 750kg 50mm ball, cast iron coupling head. Used on older P6e drawbars.
4 P00354*	Slider lock. Fits within the sliding bolt aperture on the P00355 head to prevent operation of the handle, can also be used when coupled to car.
P00355SC	Secondary coupling cable. Used with P00355 unbraked coupling head.
P00355SK	Drawbar Skid. Used on all unbraked trailers.
5 P00355PP	Electrical Plug Parking Socket. Can be fitted with braked & unbraked couplings.
6 WT5100-00020	Coupling Raiser. 20mm used on the Q#e range.



P6e with tailboard and 145/70R13 tyres.



KF13 & KF13E



EYE MAY DIFFER FROM THE PHOTOGRAPH

1 P00317-120 KF13 Coupling Unit. Pressed Steel Body 750 -1400kg GVW. 120mm bolt spacings, hydraulically damped overrun coupling unit, incorporating energy store handbrake for use with autoreverse brakes and 50mm ball head. Used on the BV*4, BV*5 – single axle, GD*4 & GD*5 – single axle ranges & P*G.

P00307 KF13E Coupling Unit. 1400kg GVW, 120mm bolt spacings, fitted with pressed steel head. Used on the EL Eurolight, P#b & Q#b ranges.

2 P00301 Coupling Head. Replacement low profile 50mm coupling head for the KF13 coupling. Includes the lock and two keys. Requires P00939 packing shim.

P003075 Pressed Steel Coupling Head KF13E. To fit 45mm drawtube. Lockable with a padded grip. For the P00307 Coupling. Used on the Eurolight range. Requires P00939 packing shim.

P00939 Packing Shim. Fits under the coupling heads P00301 & P003075.

3 P00302 Lock insert. Replacement lock for the Avonride coupling head. KF13 coupling.

4 P00303 Cover Cap. Protects the Avonride coupling head lock from ingress of dust and water. KF13 coupling.

5 P00318C 30mm Eye Kit. Includes all mounting hardware.

P00333 40mm Eye Kit. Includes all mounting hardware.

6 P00369 Bellows. Replacement protective bellows.

7 P00937 Damper. Replacement hydraulic damper for KF13, KF13E.

P00936 Damper Bracket. Holds one end of the damper rod within the body of the coupling.

8 P00938 Drawtube. Includes stop ring.

9 P00931 Powered Handbrake Upgrade Kit. Complete with oil-damped spring pack, handbrake lever and all mounting hardware etc.

P00929 Oil Damped Spring Pack.

P00928 Hand Brake Lever Assembly.

10 P00940 Overrun Lever. Fitted to the rear of the coupling unit, this lever creates the pull on the brake rod.

11 P00892 Shoulder Bolt. Fits through the centre of the overrun lever to secure the handbrake lever in place.

12 P00363 Clamp handle. Short jockey wheel clamp handle.

13 P00399 Retainer pad. Fits within the recess in the overrun unit to securely clamp the jockey wheel.

14 P00387 Breakaway cable spring ring type. It is recommended that you carry a spare breakaway cable whenever you tow.

15 P00899 Breakaway cable clevis type. For more recent knott couplings having this type of cable fitted originally.

16 P0235 Jockey Wheel Clamp. Used on the Q#b, P#b, EL101, EL142, EX202 & EL141. Compatible with the P00307 & P00308 couplings.

KF20, KFG20 & KRV20

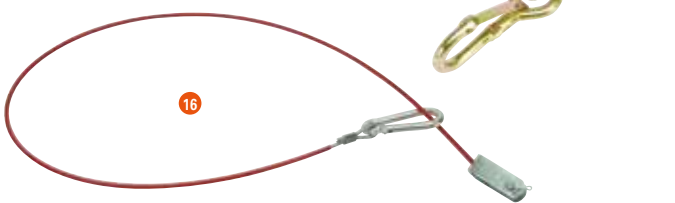
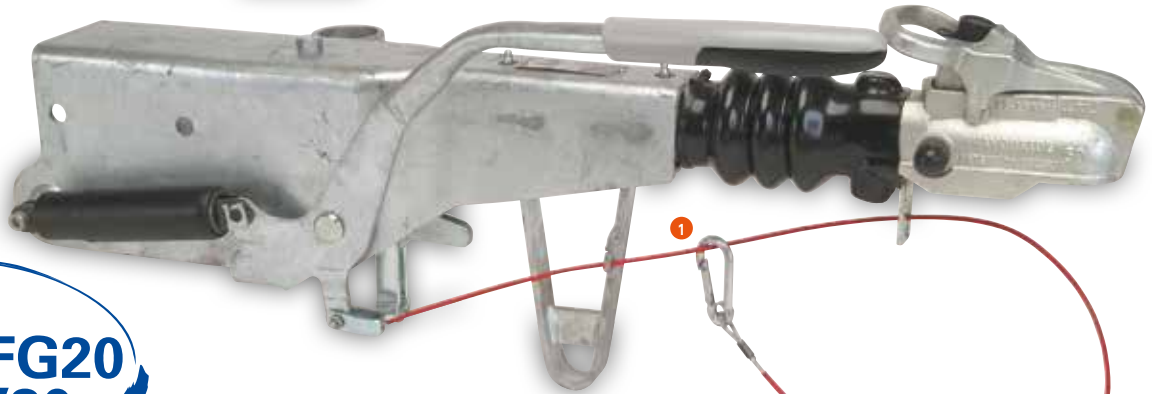

EYE MAY DIFFER FROM THE PHOTOGRAPH

- P00308** Coupling Unit KF20. 120mm centres. Lockable pressed steel head. High rear bracket. Used on the Eurolight range EX202-2515, 3015 & 3615.
- P00320** Coupling Unit KRV20 (Pressed Steel Body) For 100Mm Square Tube Drawbars. 1100-2000Kg GVW Hydraulically damped overrun coupling unit, incorporating energy store handbrake for use with autoreverse brakes and 50mm ball hitch. Used on the HB401 & HB403.
- P00324** Coupling Unit KFG20 (KPD20POD). With pressed steel head. Used on the CT115 & CT136.
- P00330** Coupling Unit KFG20. Weight range 1100 – 1200kg. 50mm lockable low profile coupling head. Used on the GH64.
- P00301** Coupling Head. Replacement lockable low profile head for the KRV20 & P00330 KFG20 couplings.
- P003085** Coupling Head. Replacement head for the P00324 KFG20 coupling. P00939 packing shim also required.
- P00302** Lock insert. Replacement lock for the Avonride coupling head. Used on the Avonride head fitted to the KFG20 & KRV20 coupling units.
- P00303** Cover Cap. Protects the Avonride coupling head lock from ingress of dust and water. Used on the Avonride head fitted to the KFG20 & KRV20 coupling units.
- P00333** 40mm Eye Kit. Includes all mounting hardware. For the KFG20 coupling.
- P00369** Bellows. Replacement protective bellows for the KF20 & KRV20 coupling.
- P00417** Bellows. Replacement protective bellows for the P00324 KFG20 coupling.
- P00373** Damper. Replacement hydraulic damper for the KF20, KRV20 & KFG20 couplings.
- P00938** Drawtube. For the KF20, KFG20 & KRV20 couplings.
- P00413** Overrun Lever. For the KFG20 couplings.
- P00940** Overrun Lever. For the KF20 & KRV20 couplings.
- P00868** Spring Pack. Oil damped unit for the KFG20 & KRV20 couplings.
- P00929** Spring Pack. Oil damped unit for the KF20 coupling.
- P00869** Handbrake Lever. For the KFG20 & KRV20 couplings.
- P00928** Handbrake Lever. For the KF20 coupling.
- P00363** Clamp Handle. Jockey clamp handle.
- P00399** Retainer Pad. Fits within the recess in the overrun unit to securely clamp the jockey wheel.
- P00387** Breakaway Cable Spring Ring Type. It is recommended that you carry a spare breakaway cable whenever you tow.
- P00899** Breakaway Cable Clevis Type. For more recent Knott couplings having this type of cable fitted originally.

KFG27



1 P00335 KFG27 Coupling Unit (Cast Body). 1400-2700kg GVW Hydraulically damped overrun coupling unit, incorporating energy store handbrake for use with autoreverse brakes and 50mm ball hitch. Used on the BV4TA, BV5G, CT136HD, GD84TA, GD5, GD6, GH94, GX4, GX5, HB505, HB510, LM5, TA5G & TT85G.

P00335-120HB KFG27 Coupling Unit 120mm bolt spacing. Used on the GD4HD, HB506, HB511, LT range, TA5G 12' x 4' & TT2515.

2 P00301 Coupling Head. Replacement lockable low-profile head for KF/KFG overrun units with a 50mm drawtube.

3 P00302 Lock Insert. Replacement lock for the Avonride coupling head.

4 P00303 Cover Cap. Protects the Avonride coupling head lock from ingress of dust and water.

5 P00404 30mm Eye. Eye kit includes all mounting hardware to fit KFG27 overrun unit.

6 P00339 40mm Eye. Eye kit includes all mounting hardware to fit KFG27 overrun unit.

P00420 50.8mm Eye Kit. Eye kit includes all mounting hardware to fit KFG27 overrun unit.

7 P00376A Nato Eye. Eye kit includes all mounting hardware to fit KFG27 overrun unit.

8 P00369 Bellows. Replacement protective bellows for drawtube of KF27 (Pressed steel body).

9 P00417 Bellows. Replacement protective bellows for drawtube of KFG27 overrun unit (Cast body).

10 P00374 Damper. Replacement hydraulic damper for KFG27.

P00878 Damper Support Bracket. Fits within body of coupling.

11 P00881 Grab Handle.

P00882 Grease nipple adaptor. Bolt that is fitted through handle.

12 P00408 Drawtube. 50 x 10 DIN2391.

13 P00869 Hand Brake Assembly KFG Low Type.

14 P00868 Oil Damped Spring Pack Knott. Oil - damped unit only, as fitted to later or upgraded units.

15 P00867 Spring Pack Mount Plate.

16 P00413 Overrun Lever. Fitted to the rear of the coupling unit, this lever creates the pull on the brake rod.

17 P00892 Shoulder Bolt. Fits through the centre of the overrun lever to secure the handbrake lever in place.

18 P00363 Clamp Handle. Short jockey clamp handle for Knott couplings.

19 P00399 Retainer pad. Fits within the recess in the overrun unit to securely clamp the jockey wheel.

20 P00387 Breakaway Cable Spring Ring Type. It is recommended that you carry a spare breakaway cable whenever you tow.

21 P00899 Breakaway Cable Clevis Type. For more recent Knott couplings having this type of cable fitted originally.



22 P00915 Manual Reverse Kit. While the basic reversing function remains automatic, this kit allows easier reversing up steep hills or on poor surfaces, where traction can sometimes be a problem. Please note Can only be fitted to the KFG27 coupling manufactured from late 2005 that has slot fitted as standard.

KFG35

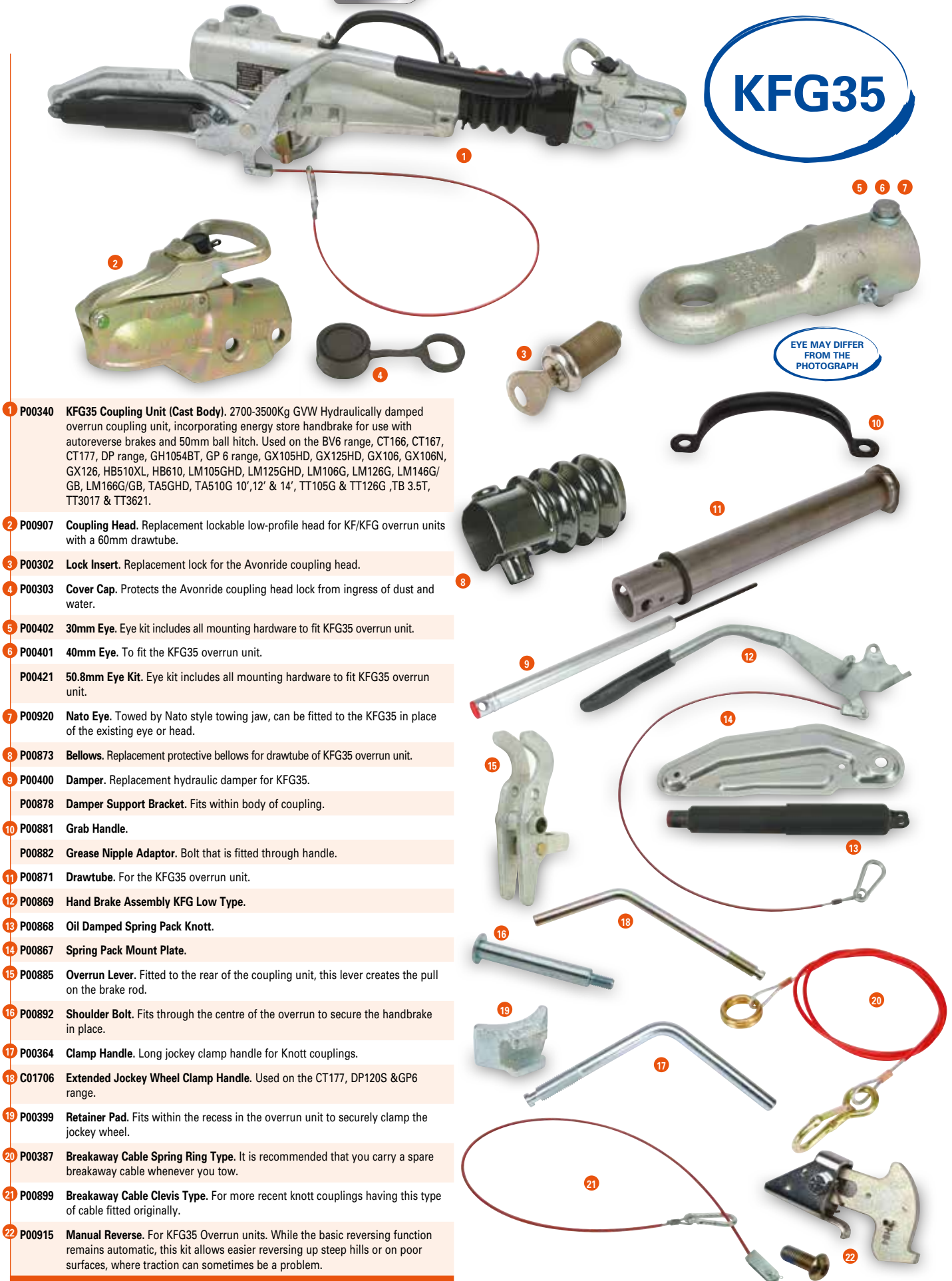

EYE MAY DIFFER FROM THE PHOTOGRAPH

- 1 P00340 KFG35 Coupling Unit (Cast Body).** 2700-3500Kg GVW Hydraulically damped overrun coupling unit, incorporating energy store handbrake for use with autoreverse brakes and 50mm ball hitch. Used on the BV6 range, CT166, CT167, CT177, DP range, GH1054BT, GP 6 range, GX105HD, GX125HD, GX106, GX106N, GX126, HB510XL, HB610, LM105GHD, LM125GHD, LM106G, LM126G, LM146G/GB, LM166G/GB, TA5GHD, TA510G 10', 12' & 14', TT105G & TT126G ,TB 3.5T, TT3017 & TT3621.
- 2 P00907 Coupling Head.** Replacement lockable low-profile head for KF/KFG overrun units with a 60mm drawtube.
- 3 P00302 Lock Insert.** Replacement lock for the Avonride coupling head.
- 4 P00303 Cover Cap.** Protects the Avonride coupling head lock from ingress of dust and water.
- 5 P00402 30mm Eye.** Eye kit includes all mounting hardware to fit KFG35 overrun unit.
- 6 P00401 40mm Eye.** To fit the KFG35 overrun unit.
P00421 50.8mm Eye Kit. Eye kit includes all mounting hardware to fit KFG35 overrun unit.
- 7 P00920 Nato Eye.** Towed by Nato style towing jaw, can be fitted to the KFG35 in place of the existing eye or head.
- 8 P00873 Bellows.** Replacement protective bellows for drawtube of KFG35 overrun unit.
- 9 P00400 Damper.** Replacement hydraulic damper for KFG35.
P00878 Damper Support Bracket. Fits within body of coupling.
- 10 P00881 Grab Handle.**
P00882 Grease Nipple Adaptor. Bolt that is fitted through handle.
- 11 P00871 Drawtube.** For the KFG35 overrun unit.
- 12 P00869 Hand Brake Assembly KFG Low Type.**
- 13 P00868 Oil Damped Spring Pack Knott.**
- 14 P00867 Spring Pack Mount Plate.**
- 15 P00885 Overrun Lever.** Fitted to the rear of the coupling unit, this lever creates the pull on the brake rod.
- 16 P00892 Shoulder Bolt.** Fits through the centre of the overrun to secure the handbrake in place.
- 17 P00364 Clamp Handle.** Long jockey clamp handle for Knott couplings.
- 18 C01706 Extended Jockey Wheel Clamp Handle.** Used on the CT177, DP120S & GP6 range.
- 19 P00399 Retainer Pad.** Fits within the recess in the overrun unit to securely clamp the jockey wheel.
- 20 P00387 Breakaway Cable Spring Ring Type.** It is recommended that you carry a spare breakaway cable whenever you tow.
- 21 P00899 Breakaway Cable Clevis Type.** For more recent knott couplings having this type of cable fitted originally.
- 22 P00915 Manual Reverse.** For KFG35 Overrun units. While the basic reversing function remains automatic, this kit allows easier reversing up steep hills or on poor surfaces, where traction can sometimes be a problem.

251S

Used on the
HB505 up to
September 1992

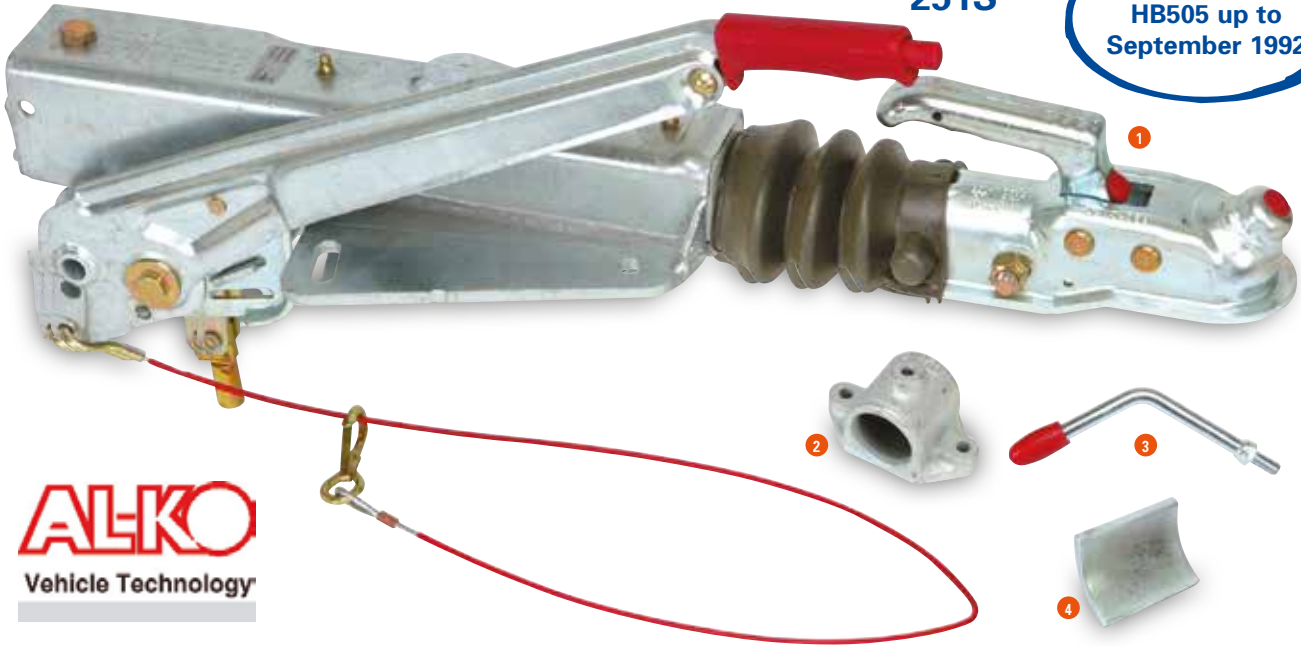

ALKO
Vehicle Technology

- 1 **P0515 251S Coupling unit.** 1500-2600Kg GVW Hydraulically damped overrun coupling unit, incorporating gas sprung handbrake for use with autoreverse brakes and 50mm ball.
- 2 **P0549 Jockey Bracket.** Type 295-191 this is used on the 251s overrun unit.
- 3 **P0549H Clamp handle.** For the 295-191 Bracket.
- 4 **P0549P Pad.** Fits within the recess in the 295-191 Bracket to clamp against the jockey wheel tube.
- 5 **P0542 Damper.** Old Type. (325mm Centres).
- 6 **P0542A Damper.** New Type. (505mm Centres).
- 7 **P0528 Head.** Replacement coupling head for 251's overrun unit.
- 8 **P0551 Bellows.** For the 251s overrun unit.
- 9 **P0545 Brake lever.** For the 251s overrun unit.
- 10 **P0548 Outer clamp.** Outer part of Jockey wheel clamp on 251S overrun unit.
- 11 **P00387 Breakaway cable.** It is recommended that you carry a spare breakaway cable whenever you tow.



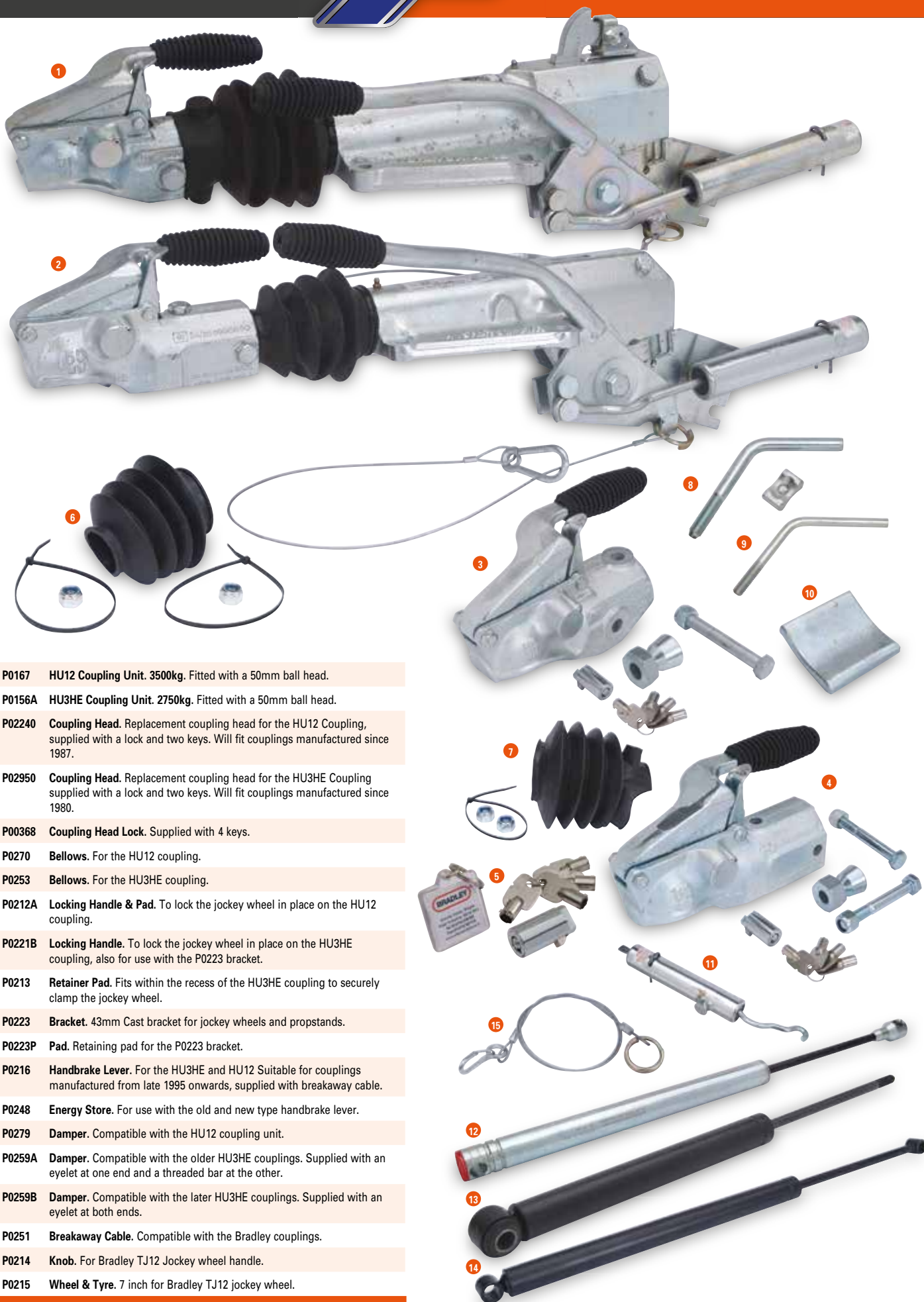

- 1 P0167 HU12 Coupling Unit. 3500kg.** Fitted with a 50mm ball head.
- 2 P0156A HU3HE Coupling Unit. 2750kg.** Fitted with a 50mm ball head.
- 3 P02240 Coupling Head.** Replacement coupling head for the HU12 Coupling, supplied with a lock and two keys. Will fit couplings manufactured since 1987.
- 4 P02950 Coupling Head.** Replacement coupling head for the HU3HE Coupling supplied with a lock and two keys. Will fit couplings manufactured since 1980.
- 5 P00368 Coupling Head Lock.** Supplied with 4 keys.
- 6 P0270 Bellows.** For the HU12 coupling.
- 7 P0253 Bellows.** For the HU3HE coupling.
- 8 P0212A Locking Handle & Pad.** To lock the jockey wheel in place on the HU12 coupling.
- 9 P0221B Locking Handle.** To lock the jockey wheel in place on the HU3HE coupling, also for use with the P0223 bracket.
- 10 P0213 Retainer Pad.** Fits within the recess of the HU3HE coupling to securely clamp the jockey wheel.
- P0223 Bracket.** 43mm Cast bracket for jockey wheels and propstands.
- P0223P Pad.** Retaining pad for the P0223 bracket.
- P0216 Handbrake Lever.** For the HU3HE and HU12 Suitable for couplings manufactured from late 1995 onwards, supplied with breakaway cable.
- 11 P0248 Energy Store.** For use with the old and new type handbrake lever.
- 12 P0279 Damper.** Compatible with the HU12 coupling unit.
- 13 P0259A Damper.** Compatible with the older HU3HE couplings. Supplied with an eyelet at one end and a threaded bar at the other.
- 14 P0259B Damper.** Compatible with the later HU3HE couplings. Supplied with an eyelet at both ends.
- 15 P0251 Breakaway Cable.** Compatible with the Bradley couplings.
- P0214 Knob.** For Bradley TJ12 Jockey wheel handle.
- P0215 Wheel & Tyre.** 7 inch for Bradley TJ12 jockey wheel.



- 1 P0475 Jockey wheel 48mm.** Heavy duty ribbed shaft design and heavy duty tyre. Suits the Bradley HU12, Knott KFG35 couplings or the P0209 clamp.
- 2 P0475H Jockey wheel 48mm.** Heavy duty version with extended slimline handle for extra clearance against winch brackets. Fitted with the P04751 tyre.
- 3 P0474 Jockey wheel 48mm.** Medium duty smooth stem design, suits the Knott KF13, KF13E, KF20, KFG20, KRV20 KFG27 & Alko P0515 couplings.
- 4 P0476 Jockey wheel 42mm.** Standard duty smooth stem design, suits the Bradley HU3H & HU3HE couplings.
- 5 P0567 Jockey Wheel 35mm.** Suits the BV64e, P5, P6e, P7e, P8e, Q range and the unbraked Eurolight.



- 6 KX0221 Propstand kit.** Pair of propstands for the GD range.
- 7 KX0222 Propstand kit.** Pair of propstands for the Box Van and Horsebox range.
- KX0224 Propstand kit.** Pair of propstands for the BV4 & BV5 range.
- KX0225 Propstand kit.** Pair of propstands for the P#e, P#b & Q ranges.
- KX0233 Propstand kit.** Pair of propstands for the HB403, HB506 & HB511.



- 8 P04741 Wheel.** Wheel & tyre 52mm x 200mm diameter. Suits the P0474, P0476 & P0567 Jockey wheels.
- 9 P04743 R clip.** Includes chain, as fitted to P0474, P0475 & P0476.
- 10 P04744 Axle tube.** Fits items 3 & 4.
- 11 P04745 Thrust bearing unit.** Fits between inner and outer stem of P0475, P0475H, P0474 & P0476 Jockey wheels.
- P04746 Thrust Bearing Washer.** To be fitted with the P04745 thrust bearing.
- 12 P04751 Wheel.** Wheel and tyre 75mm wide x 235mm diameter. Suits the older P0475 Jockey wheels and P0475H Jockey wheels.
- 13 P04752 Wheel.** Wheel and tyre 60mm wide x 210mm diameter. Suits the current P0475 Jockey wheel.
- 14 P04754 Jockey wheel axle.** For the wide tyre fitted to heavy duty ribbed jockey wheels.
- 15 P0209 Clamp bracket.** Complete clamp bracket for all our ribbed heavy duty jockey wheels & propstands.
- P0209SP Split pin.** Fitted through top of heavy duty prop stand.
- P0209H Handle.** For heavy duty prop stand clamp.
- P0209N2 Nut M16.** (Clamp nut used in the P0209 bracket).
- P0221 Propstand bracket.** Mounting bracket for 35mm propstand or jockey wheel, requires pad and handle to complete.
- P0221P Retainer pad.** Fits within the recess of the P0221 bracket.
- P0221H Clamp handle.** M12 for metric propstand clamps.
- P0223 Jockey bracket.** P200 bracket for fitting 42mm diameter jockey wheels or propstand tubes.
- P0223P Pad.** For bracket P0223.
- P0221B Clamp handle.** 1/2" For the P0223 Bracket.



- 16 AS5875 Propstand Leg.** Used on the P5, P6, P7, P8 & Q ranges. 460mm.
- AS5874 Propstand Leg.** Used on the BV4 & 5, HB & GD ranges. 560mm.
- P0197 Propstand leg.** Serrated shaft, used on the BV6 range with 12" wheels. 590mm.
- P0196 Propstand leg.** Serrated shaft, used on the BV6 range with 16" wheels. 720mm.

- 1 KX0227 Propstand Kit.** Pair of propstands and fittings. Compatible with the Beavertail, Flatbed and old tipper range.
- KX0220 Propstand kit.** Pair of propstands and fittings for current LT/LM85 trailer range.
- KX3185 Propstand Kit.** Pair of propstands, spigots and backing plates for the Eurolight range.
- 2 KX6316 Propstand Kit.** Pair of propstands for the current TT Tipper range.
- P1114 Propstand.** Individual propstand. Compatible with the Beavertail, Eurolight & Flatbed range.
- P11145 Propstand.** Individual propstand leg for the TT range.
- 3 P1115/P Pin Assembly.** Compatible with the P1114 & P11145 propstands.
- 4 P11170G Bolt on Spigot.** Compatible the Beavertail, Flatbed and old Tipper range.

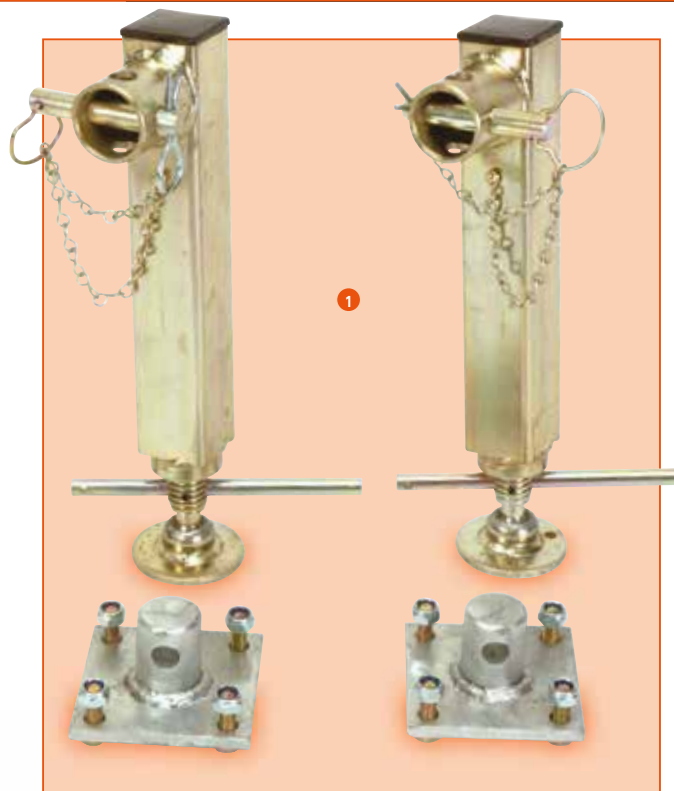

- LM146 with headboard, dropsides, mesh sides, ramp and prop stands.

Trailer Security and Load Restraint



Contents

Trailer Security

Load Restraint

Page

57

58

1 KX8105 Ifor Williams Coupling Head Lock. The lock is designed to fit 50mm ball couplings fitted with the Avonride head – and will suit most braked trailers in the Ifor Williams range (the only exceptions are the CT115, CT136, Eurolight range, P*b & Q*b).

The coupling head security lock has been designed and manufactured to resist attack and uses toughened steel and high security barrel lock mechanisms. In rigorous security testing, the lock has been awarded 'Gold Standard' by 'Sold Secure' - a major UK test house.

The coupling head lock is plated all over and in addition the upper section is powder coated. The internal elements of the lock are made from non-rusting materials. A convenient weather-proof cover is also provided which covers the whole lock to give additional protection.

A spare barrel lock is supplied giving the option of replacing the lock on the coupling head of the trailer enabling the use of the same key to open both locks. (The coupling lock comes with a total of four keys)

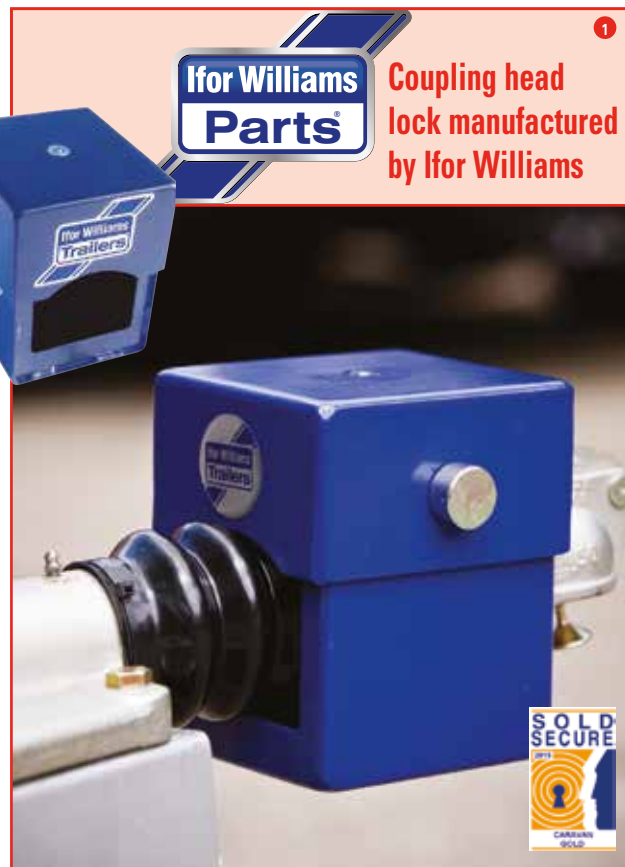



- 1 P1046 Cargo Strap & Ratchet.** 3 metre long.
- 2 P1049 Cargo Strap & Ratchet.** 8 metre long.
- P10495 Cargo Strap.** 3 metre long ratchet cargo strap.
- 3 P1042 Wheel Securing strap.** For use on the CT177
- 4 KX0201 Lashing Ring Kit.** Used on the GX range. The kit contains one recessed lashing ring, one mounting plate, nuts, bolts & washers.
- 5 KX0202 Lashing Ring Kit.** Used on the Box van range. The kit contains one recessed lashing ring, one mounting plate, nuts, bolts & washers.
- 6 KX0206 Lashing Ring Kit.** Used on the Flatbed, Beavertail range. The kit contains one recessed lashing ring, one mounting plate, nuts, bolts & washers.
- 7 KX0651 Lashing Point Kit.** Used on the Unbraked range. The kit contains two lightweight lashing points, nuts, bolts & washers.
- 8 KX3190 Lashing Ring Kit.** Used on the Eurolight range. The kit contains two recessed lashing rings, nuts, bolts & washers.
- 9 KX6318 Single Lashing Point.** Used on the current Tipper range. The kit contains one U bolt and nuts.
- 10 KS3740 Bolt On Lashing Lug Kit.** One pair, compatible with the GH range.
- 11 KS0204 Lashing Lug Kit.** Used on the GX range, mounted on the side panel (Internal). The kit contains two lashing lugs, two back plates, nuts & bolts.



- 12 P12451 Rope Cleat.** Round plastic cleat used on P5 model.
- 13 C04663 Rope Hook.** Used on the Low loader range of trailers.
- 14 C04664 Rope Hook.** Formed rope hook used on general duty trailer models.
- 15 C04667 Rope Hook.** Used on the unbraked & P*b ranges.
- 16 C04669 Rope Hook.** Used on the Eurolight range.

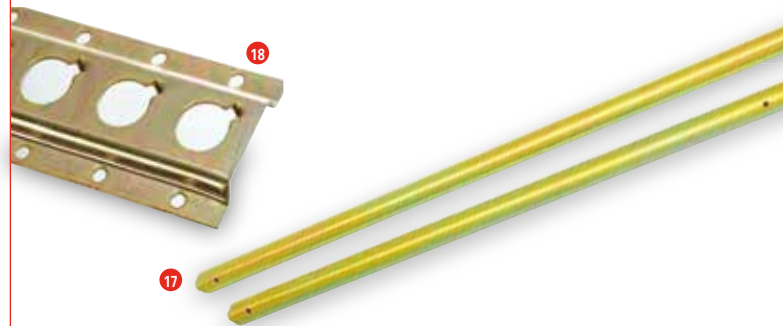

- 17 P1050 Shoring Pole.** BV4 Series spring loaded pole that fits between the receiver tracks to secure upright loads.
- P1047 Shoring Pole.** BV5 Series spring loaded pole that fits between the receiver tracks to secure upright loads.
- P1048 Shoring Pole.** BV6 Series spring loaded pole that fits between the receiver tracks to secure upright loads.
- 18 P1035 Receiver Track.** Allows for the use of shoring poles, 2.40m.
- P1036 Receiver Track.** Allows for the use of shoring poles, 3.10m.
- P1037 Receiver Track.** Allows for the use of shoring poles, 3.62m.

Hardware & Ironmongery

Hinges & gas struts • Coiled springs • Ramp fasteners • Inspection door fittings
fittings • Linch pins & Antiluce fasteners • Door stops, spacers & washers

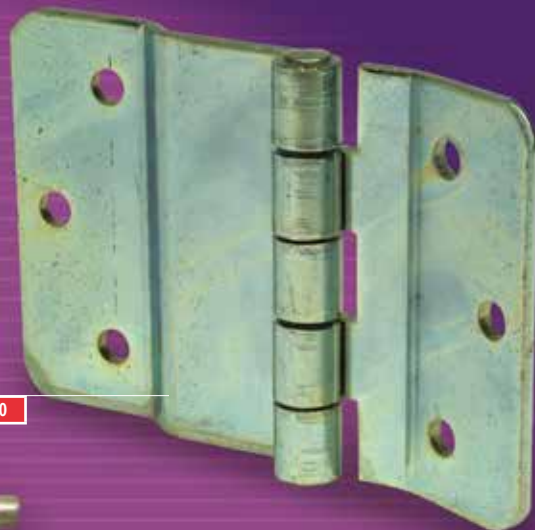

Hinge Page 60



Spring Bolt Page 62

Ramp Fasteners Page 62



Coiled Springs Page 61



Hinge Page 60



Inspection Door Fittings Page 63

Contents

Page

Hinges & Gas Springs

60

Coiled Springs

61

Ramp Fasteners

62

Inspection Door Fittings

63

Linch Pins, Receivers & Antiluce Fasteners

64

Door Stops, Holders, Spacers, Bushes & Washers

65

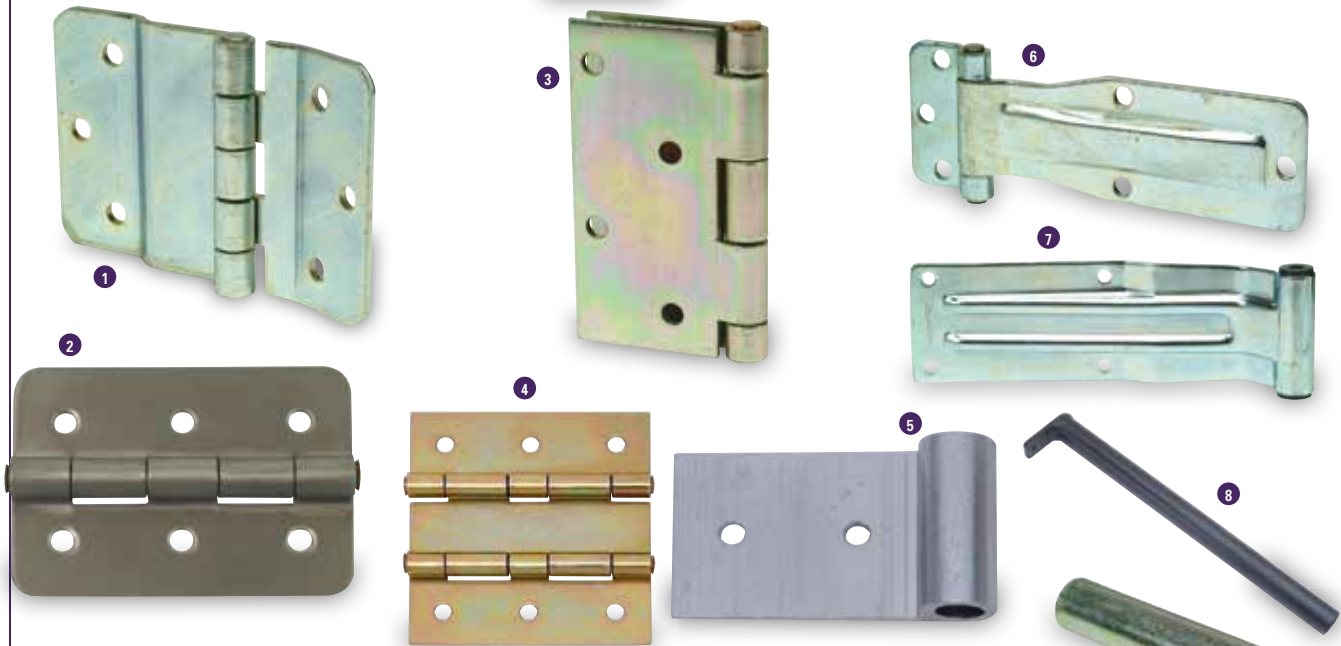

HINGES & HINGE PINS

- 1 P1070 Hinge.** Inspection door hinge for Boxvans.
- 2 P1072SS Stainless steel hinge.** Used on the inspection doors of the old HB range, Tipper Toolboxes, Beavertail skid carriers & CT136 number plate.
- P10725 Hinge.** Inspection door hinge HB510XL & HB610.
- 3 P1074 Hinge.** 4" butt hinge BV ramp/doors.
- 4 P1075 Double Knuckle Hinge.** Used to hinge the inner & outer sections of the folding aluminium sheep decks together.
- 5 C44934 Outer Deck Hinge Leaf.** Used to hinge the outer sheep deck section to the side of the trailer. Requires F0334Z Bolt for the 2 leaf hinge and F0332Z for the 3 leaf hinge.
- 6 P1077 Hinge.** Box van rear door hinge for BV4 range.
- 7 P1078 Hinge.** Box van rear door hinge for BV5 & BV6 range.
- 8 AS0558 Ramp Hinge Tube.** Used on the current GD & GX ranges.
- 9 AS8214 Hinge Pin.** Fitted through the lighting bracket this pin acts as pivot for the tailboard or ramp on P5, P6e, P7e & P8e & Q range.
- 10 C74427 Bush.** Ramp hinge bush P5, P6e, P7e & P8e & Q range.
- 11 C20937 Ramp Hinge Tube.** Nylon coated hinge pin. Used on the DP range, Box Van ramp doors, HB510XL, HB610 & GP range.
- 12 P1246 Ramp Hinge Pivot Bush.** Used on the Livestock range, Box Van ramp doors, GX, HB510XL & HB610.
- 13 KS0810 Ramp Hinge Tube Kit.** Used for pre 1997 Livestock trailers and Imperial GD ramps.

GAS SPRINGS

- P1186 Gas Spring.** Used within the gas strut kit for the LandRover V379, V381 and V383 models. 230N.
- P1186A Gas Spring.** Used within the gas strut kit for all other models of canopies 230N.
- P1186B Gas Spring.** Used on the P5e GRP lid.
- 14 P1188 Gas Spring.** Used on Easyload ramps and the latest Rear barrier mechanisms on livestock trailers & opening wind deflector kits. 1000N.
- P1189 Gas Spring.** Used on the ramps for the CT166/167, GD & GX84 6' ramp. 1700N.
- 15 P1191 Gas Spring.** Used on the HB403, HB506 & HB511 front and rear ramps. HB401, 505 & 510 front ramps, TB ramp kits, Beavertail 6' ramps, GP & GX ramps. 2100N.
- 16 P1192 Protective Bellows.** Used on the Horsebox, CT, GD, GP & GX ranges.
- P1193 Gas Spring.** This gas spring will eventually supersede P1191 totally over a period of 9 months starting in September 2016. (The two parts are interchangeable). 2100N



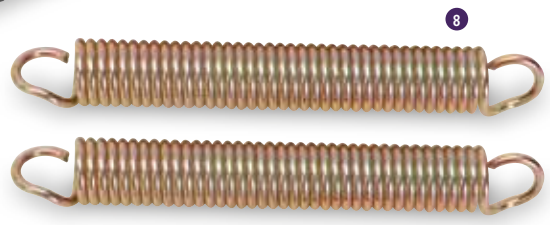

- 1 P1159** Ramp Spring. Used on the GH94BT & GH1054BT rear ramps. Overall length 520mm.
- P1159-00470** Ramp Spring. Used on the GH64 rear ramp. Overall length 470mm.
- 2 P1161** Ramp Spring. Used on TA5, TA510G & DP ramps, BV6 ramp doors & HB610 rear ramps. Overall length 660mm.
- P1162** Ramp Spring. Used on container front ramps. Overall length 640mm.
- 3 P1163** Ramp Spring. Used on HB401, HB505 & HB510 rear ramps, GH94 ramps, BV4, BV5 Rear ramp doors & HB510XL rear ramps. Overall length 640mm.
- 4 P1165** Ramp Spring. Used on the older GX ramps and the TA5G 4' rear ramp. Overall length 280mm.
- 5 P1167** Ramp Spring. Used on the BIAB, Container, Eventa and Transporta rear ramps. Overall length 720mm.
- 6 P1168** Ramp Spring. Used on the imperial GD range. Overall length 300mm.
- 7 P1184** Rear Ramp Spring. Used on the BIAB, Container, Eventa and Transporta rear ramps. Overall length 723mm
- KS0800** Ramp Spring kit. Includes 2 x P1163 springs, 2 x C00215 J Bolts & 6 x F1005Z nuts.
- 8 KS0803** Ramp Spring Kit. Includes 2 x P1168 springs, 2 x C00216 J bolts & 2 x F1005Z.
- C70310** Ramp Spring Cover. Used on the HB510XL & HB610 to cover the top of the spring.
- 9 C70311** Ramp Spring Cover. Used on the HB401, 505, 510 and Container rear ramps to cover the top of the spring.



RAMP FASTENERS

- 1 C00049 Sliding Bolt.** Vertical locking bolt used on the HB505 ramp door model, BV4, BV5 & BV6 Ramp doors & TA5, TA510 ramp doors.
- C00263 Sliding Bolt.** Horizontal, used on the BV126G 7' Ramp Doors.
- C40142 Sliding Bolt.** Horizontal locking bolt used on the HB505 ramp door model, BV4, BV5 & BV6 Ramp doors & TA5, TA510 ramp doors.
- P1173 Spring.** Used with the vertical sliding bolts.
- 2 P12361 Moulded Pin & Knob.** Used with the sliding bolts on the Box Van & Livestock.
- 3 C70136 Spring Bolt Guide Bush.** Used on the Boxvan range with ramp doors. 4 per trailer.
- 4 C01690 Ramp Closure Lock Pin.** Used on the Boxvan ramp door range and Livestock rear ramps.
- 5 C14324 Ramp Closure Handle.** Right hand used on the Boxvan ramp door range and Livestock rear ramps.
- C14325 Ramp Closure Handle.** Left hand used on the Boxvan ramp door range and Livestock rear ramps.
- P1288 Ramp Closure Spring.** Used on the Boxvan ramp door range and Livestock rear ramps.
- 6 C30709 Ramp Fastener Ramp Handle.** M14. Used on the GD, GH, GP & GX ranges to secure the ramps & skids.
- 7 P10885 Ramp Fastener Eye Bolt.** M14. Used on the GD, GH, GP & GX ranges to secure the ramps & skids.
- 8 AS5087 Spring Bolt.** Used to secure the Imperial GD tailboard.
- 9 AS5870 Spring Bolt.** Used on imperial GD ramps, metric GD tailboards, current large cross divisions and livestock barrier kits.
- 10 C00120 Door Stay.** Used on the BV4 range to hold the van doors open.
- C00256 Door Stay.** Used for holding the ramp doors open on the BV6 range.
- C00266 Door Stay.** Used for holding the ramp doors open on the TA5G & TA510G.
- P1023 Plastic Clip.** Used to secure the door stays when not in use.
- C00898 Fixing Bracket.** Secures the door stays on the Box Van ramp door / van door combinations and Livestock ramp doors.
- 11 C31249 Ramp Fastener Handle.** Used on the old Horsebox Range front and rear ramps and the HB510XL rear ramp.
- 12 P1079 Over Centre Ramp Catch.** Used on the front and Rear ramps of HB610 & containers
- 13 P1053 Handle.** Locking handle with 180 degree movement between open and closed, 8mm square operating shaft. Used on the rear doors of Box Vans. With ramp doors.
- 14 P1054 Handle.** Chrome lever handle used on box vans with van doors.

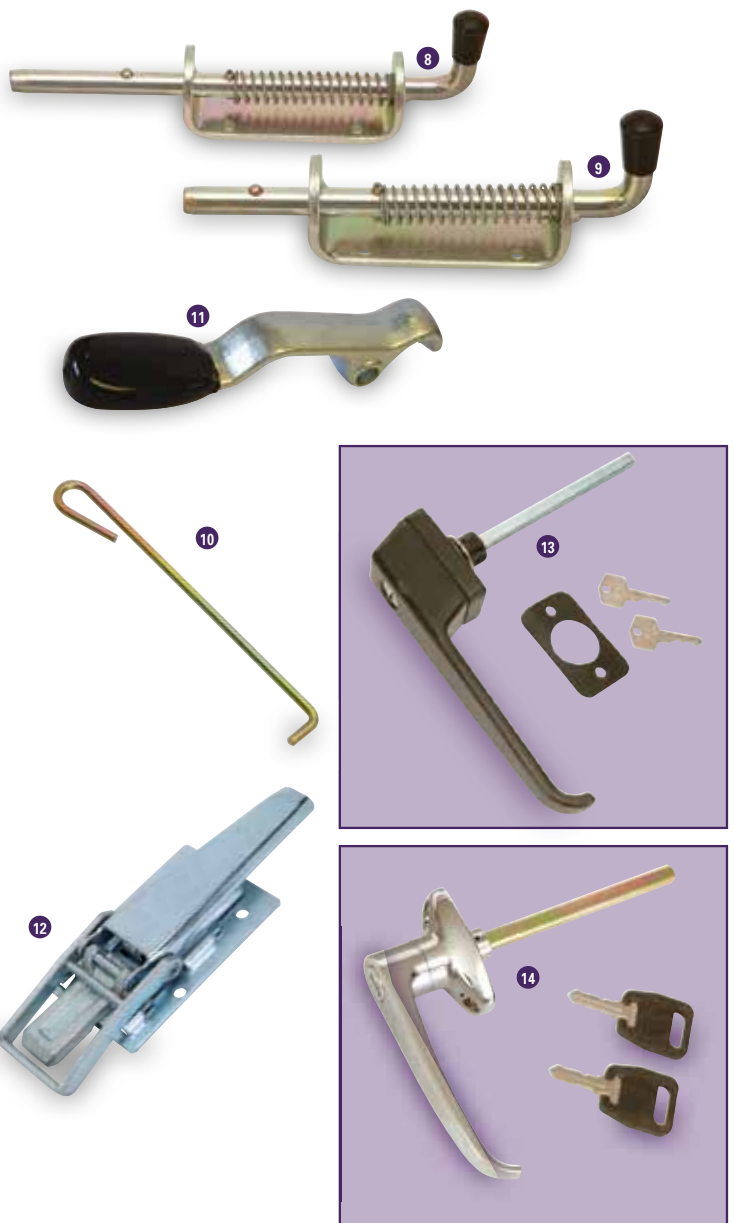

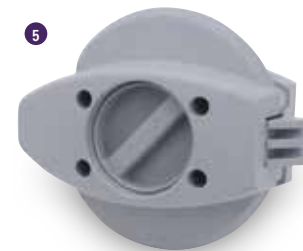
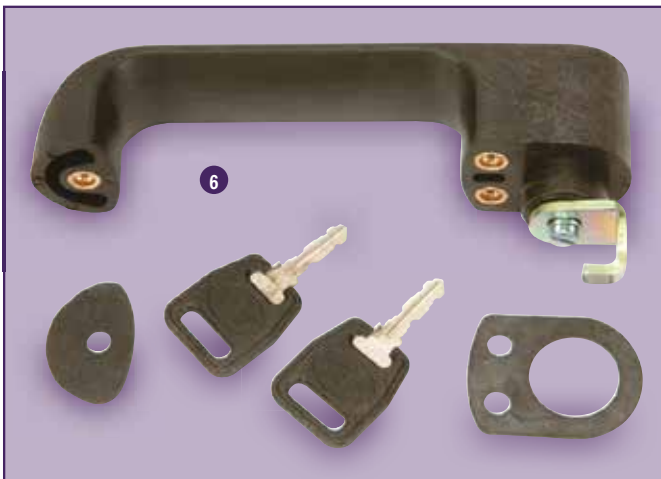

- 1 P1066 Paddle Latch.** Lockable Inspection door latch. Used on the classic horsebox HB510XL & HB610.
- 2 C00272 Inspection door latch.** Used on the older Classic HB range to secure the paddle latch P1066.
- AS4275 Latch Keep.** Used on the HB510XL & HB610 to secure the paddle latch P1066.
- C00273 Latch Keep Bridge.** Used on the HB510XL & HB610.
- C70322 Latch Cover.** Used on the older Classic HB range, HB510XL & HB610.
- 3 P1803 Inspection Door Lock.** Outer assembly. Used on the current HB range and the Eventa Inspection door, storage and toilet doors.
- 4 P1804 Inside Latch.** Used on the Eventa inspection door
- 5 WA00460 Inspection Door Inner Latch.** Used on the current Horsebox range.
- 6 P10580 Handle.** Push button handle used on BV4 & BV5 inspection doors.
- 7 P1059 Inner Latch.** RH internal door latch mechanism as used on boxvans with left side inspection doors. Compatible with the P10580 handle.
- P1060 Inner Latch.** LH internal door latch mechanism as used on boxvans with right side inspection doors. Compatible with the P10580 handle.
- AS0254 Inspection Door Locking bar bracket.** Top, used on the BV6 7' Inspection door.
- AS0255 Inspection Door Locking bar bracket.** Bottom, used on the BV6 7' Inspection door.
- AS0256 Inspection Door Locking Bar Assembly.** Used on the BV6 7' Inspection door.
- AS0258 Inspection Door Latch Assembly.** Used on the BV6 Inspection door.
- AS1691 Inspection Door Handle.** Used on the BV6 inspection door.

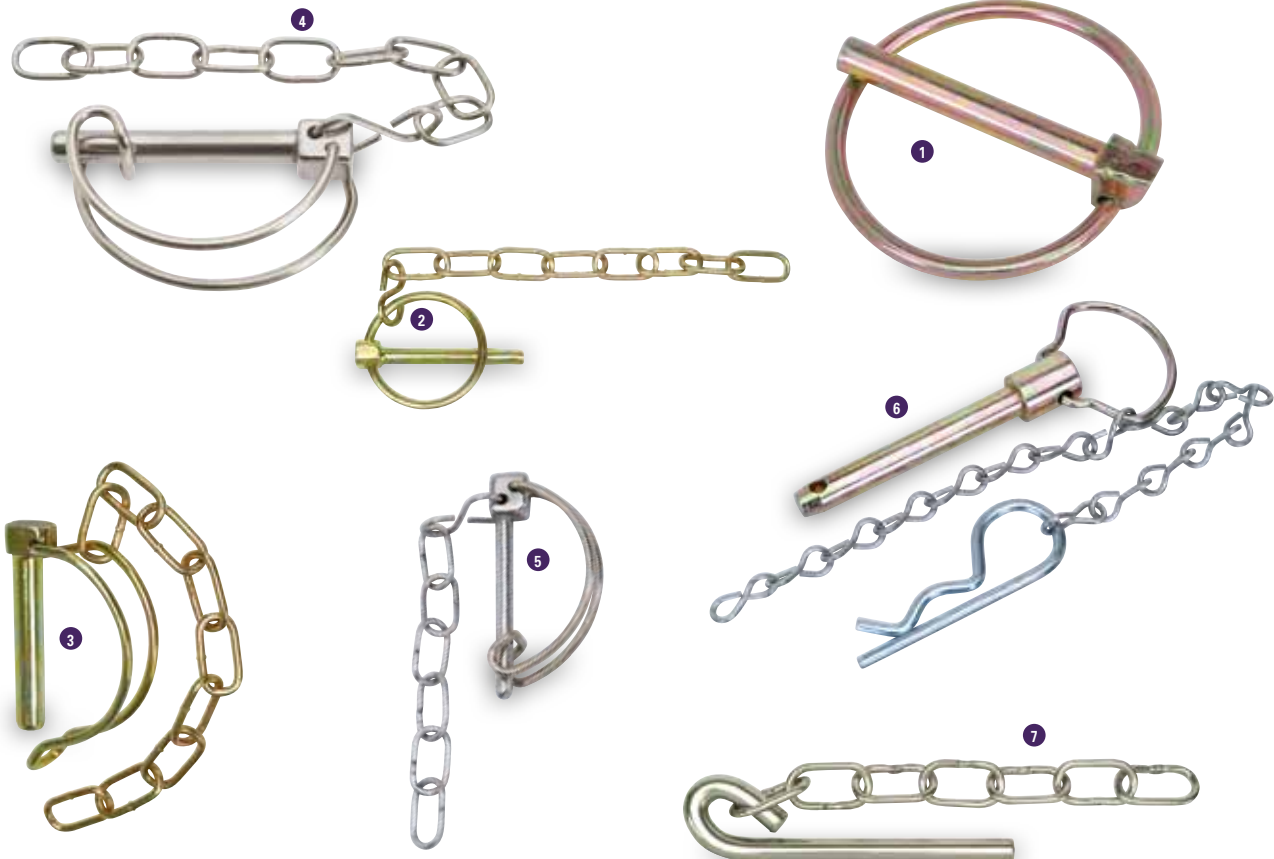

LINCH PINS & RECEIVERS

- 1 P1110/LS** **Cross Division Storage Pin.** To secure the large cross division to the front panel of livestock trailers.
- 2 P1110/50SS** **Linch Pin.** ¼ inch diameter stainless steel lynch pin with retainer chain fitted. Used on the horsebox range, to secure unbraked trailer ramps and tailboards and to secure drop side and mesh kits.
- 3 P1096** **Linch Pin.** Used on the CT136 & TB wheel chock kits, CT115 & CT136 winch mounting kits and on the older style Tipper rear pillars.
- 4 P1098** **Linch Pin.** Stainless steel, used within the body kit and mesh kits for the TT2515, TT3017 & TT3621.
- 5 CP00581** **Linch Pin & Chain.** Used on the current HB403, HB506 & HB511 to secure ramp latch.
- 6 P11155** **Pin Assembly.** HB510XL & HB610 telescopic partitions.
- 7 P11190** **Pin & Chain.** Used to secure the front and rear ramps on the old horsebox range and to secure the rear ramp on the HB510XL.
- 8 P1099** **Linch Pin Receiver.** Used on Eurolight, P6e, P7e & P8e mesh kits.
- 9 P1105** **Linch Pin Receiver.** Bolt on, used on many mesh side kits (headboard connection) & LT/LM ramp pillars.
- 10 P1107** **Linch Pin Receiver.** Used on livestock trailer back rails, rear barriers, Q range mesh & sold panel kits and hinged mesh kits.

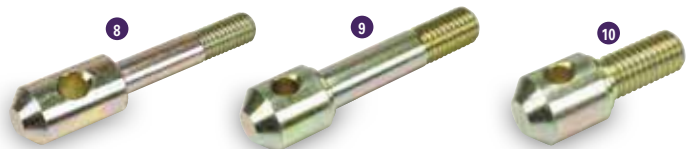

ANTILUCE FASTENERS

- 11 P1003D** **Antiluce.** As used on rear ramps of horseboxes (older models), livestock trailers and canopies.
- 12 P1005D** **Antiluce.** Used within the metric GD mesh kits.
- 13 P1007D** **Antiluce.** Used within the sheep deck kits, folding front panel kits, opening wind deflector kits and the older horsebox range inspection doors.
- 14 P1009D** **Antiluce.** Used on P6/8, TA5/510 and DP inspection doors.
- P1010D** **Antiluce.** Used on the Eventa ramp gate assemblies.





DOOR STOPS & HOLDERS

- 1 P1012F Door Holder Blue (Female).** Used on the current horsebox range to hold the inspection door open, Eventa M Ramp gate and inspection door assemblies.
- 2 P1012M Door Holder (Male).** Used with P1012F to hold the inspection door open on the current horsebox range, HB510XL, HB610, Eventa M Inspection door and livestock deck kits.
- 3 P1012S Door Holder (Female).** Used on the HB510XL & HB610, Livestock deck barriers, CT115 & 136 to secure the rear light brackets & TB Stowable skid kits.
- 4 P1014 Door Stop.** Currently used on the Box Van roller shutter and ramp door kits, back rail assemblies, sheep deck kits and Land Rover canopies, Eventa side step, hinged mesh kits & P5e hard top.
- 5 P10141 Door Stop.** Used on livestock ramp side gates, DP cross divisions & TB dropside & ramp kits.
- 6 P1015 Door Stop.** Used on the TA5G & TA510G cross divisions, P5, P6, P7 & P8e ramps, BV ramp door kits & livestock deck kits.
- 7 CP00463 Door Stop Bracket.** Fitted to the current horsebox range, bolts to the coupling.
- 8 P10151 Top Hat Buffer.** Used on the current Tipper skid carrier kits and Beavertail skid rack kits.

SPACERS & BUSHES

- 9 C70689 Ramp Side Gate Pivot Bush.** Fitted to the floor of the sealed floor livestock trailers.
- 10 C74419 Livestock Deck Pivot Bush.** Fitted to the upper sheep deck for locating the small cross division.
- 11 C75363 Ramp Gate Capping Insert.**
- 12 P1245PK Deck Cleat.** Fitted to the side panel of the current livestock trailer to secure the vents in the open position. Sold in packs of 10.
- 13 P1246 Hinge Pivot Bush.** Used on the ramp installations for the GP, GX, Metric GD range, new and old horsebox range Eventa, HB510XL, HB610, TA5G & TA510G rear ramps.
- 14 C74427 Hinge Pivot Bush.** Used on the P5e, P6e, P7e & P8e Ramp & Tailboard installations.

WASHERS

- 15 P1274 Square Neoprene Washer.** To prevent any rattle on the drop side kits and centre and rear pillars LT/LM & hinged & mesh Q side kits.
- 16 P1280 Rubber Washer/Antiluce Pad.** Used on the unbraked mesh kits and canopy rear doors & sheep deck kits.
- 17 P1281 Natural LDPE Washer.** Used to prevent rattle on mesh side kits.



Lighting & Electrical

Cable & Wiring accessories • Lamps • Lighting kits

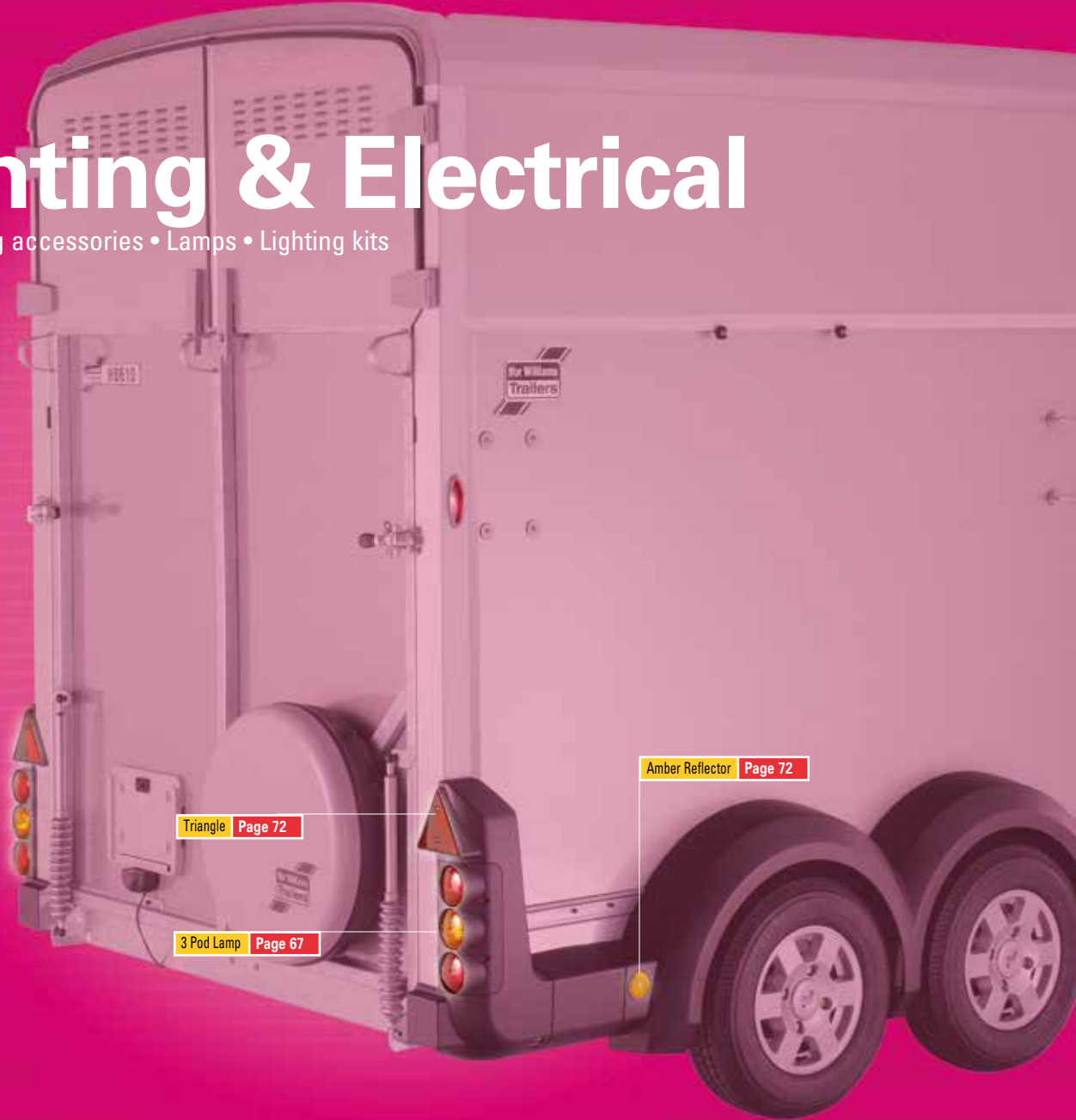

Contents

	Page
Rear Combination Lamps	67
Rear Combination Lenses, Multifunction Rear Lamps & Lenses	68
Fog Lamps, Reverse Lamps & Number Plate Lamps	69
Front Position & Outline Marker Lamps	70
Rear Position & Side Outline Marker Lamps	71
Reflectors, Interior Lamps & Lighting Kits	72
Light Leads, Harnesses & Accessories	73
Quick Reference Guide	74

- 1 P0669 Rear Combination Lamp.** Stop/ tail and indicator functions.
- 2 P06691/R Rear Combination Lamp.** Stop/ tail and indicator functions. Cable coloured for RH fitting
- P06691/L Rear Combination Lamp.** Stop / tail and Indicator functions. Cable coloured for LH fitting.
- 3 P06770 Rear Combination Lamp.** Rubber bodied Stop/ tail and indicator functions. Supplied with 4 metres of cable coloured for right hand use.
- P06771 Rear Combination Lamp.** Rubber bodied Stop/ tail and indicator functions. Supplied with 4 metres of cable coloured for left hand use.
- 4 P06778 Rear Combination Lamp.** Rubber bodied Stop/ tail and indicator functions. Supplied with 2 metres of cable coloured for right hand use.
- P067781 Rear Combination Lamp.** Rubber bodied Stop/ tail and indicator functions. Supplied with 4 metres of cable coloured for right hand fitting. Used on the GH range.
- P06778A Rear Combination Lamp.** Vertical Rubber bodied Stop/ tail and indicator functions. Used on the HB610.
- P06779 Rear Combination Lamp.** Rubber bodied Stop/ tail and indicator functions. Supplied with 0.8 metres of cable coloured for left hand fittings
- P067791 Rear Combination Lamp.** Rubber bodied Stop/ tail and indicator functions. Supplied with 4 metres of cable coloured for left hand fittings. Used on the GH range.
- 5 P06783 Rear Combination Lamp.** Rubber bodied Stop/ tail and indicator functions. Supplied with 2 metres of cable coloured for right hand use.
- P067836 Rear Combination Lamp.** Rubber bodied Stop/ tail and indicator functions. Supplied with extra long length of cable coloured for right hand use. Used on the CT136.
- P06784 Rear Combination Lamp.** Rubber bodied Stop/ tail and indicator functions. Supplied with 0.8 metres of cable coloured for left hand use.
- P067841 Rear Combination Lamp.** Rubber bodied Stop/ tail and indicator functions. Supplied with extra long length of cable coloured for left hand use. Used on the CT136 & CT177.
- 6 P07983 Round Stop / Tail Lamp.** Tungsten. Used on the BIAB, Eventa & TB ranges.
- P079831 Round Stop / Tail Lamp.** LED with 2000mm cable. Available as an option for the TT & TB ranges.
- 7 P07984 Round Indicator Lamp.** Tungsten. Used on the BIAB, Eventa & TB range.
- P079841 Round Indicator Lamp.** LED with 2000mm cable. Available as an option for the TT & TB ranges.
- 8 P1812 Round Stop / Tail Lamp.** Used on the current horsebox range.
- 9 P1813 Round Indicator Lamp.** Used on the current horsebox range.
- 10 P1851 Rear Combination Lamp.** Rubber bodied stop/ tail, indicator and reverse functions. For right hand use. Fitted to the HB510XL.
- 11 P1880 Pro -Disc LED Indicator / Stop / Tail / Triangle lamp.** Available as an LED option for the GD, GP & GX ranges.**
- 12 P1885-05 Mini LED Indicator/Stop/ Tail.** 12V/ 24V 0.5m. Available as an LED option for the Flatbed range.**
- P1885-20 Mini LED Indicator /Stop/ Tail.** 12V/ 24V 2.0m. Available as an LED option for the Flatbed range.**
- P1885-50 Mini LED Indicator/Stop/ Tail.** 12V/ 24V 5.0m. Available as an LED option for the GH range.**



** Some vehicles present so far insoluble problems when coupled to a trailer with LED lights. This may take the form of the hazard warning lights flashing continuously and there may be other problems too. Many other vehicles perform faultlessly when connected to LED equipped trailers. However, where such problems do occur, these are vehicle problems and Ifor Williams Trailers will not be responsible for their resolution. Owners are strongly advised to make thorough checks with the vehicle manufacturer before buying or specifying LED trailer lights.

REAR COMBINATION LENSES

- 1 **P0704 Rear Combination lens.** For the P0669 lamp.
- 2 **P06691LS Rear Combination lens.** For the P06691/L & P06691/R lamps.
- 3 **P06770/F Fog Lens.** Used on the 2 & 3 pod rubber bodied lamps.
- 4 **P06770/I Indicator Lens.** Used on the 2 & 3 pod rubber bodied lamps.
- 5 **P06770/T Stop / Tail Lens.** Used on the 2 & 3 pod rubber bodied lamps.
- 6 **P067831 Rear Combination Lens.** Used on the P06783, P067836, P06784 & P067841 lamps.

MULTIFUNTION REAR LAMPS

- 7 **P1870 Multipoint 5 Combi Lamp.** Right hand. With stop/tail, indicator, fog, reverse and side number plate illumination. Plug in 6 pin connector. Used on the current Beavertail & CT166/167.
- 8 **P1871 Multipoint 5 Combi Lamp.** Left hand. With stop/tail, indicator, fog, reverse and side number plate illumination. Plug in 6 pin connector. Used on the current Beavertail & CT166/167.
- 9 **P07943 Multifunction Rear Lamp.** Right hand, includes fog, stop/ tail, indicator, outline marker and warning triangle. Used on the CT136 & CT177 up to April 2008.
- 9 **P07944 Multifunction Rear Lamp.** Left hand, includes fog, stop/ tail, indicator, outline marker and warning triangle. Used on the CT136 & CT177 up to April 2008.
- 10 **P07946 Multifunction Rear Lamp.** Right hand, includes number plate illumination, stop/ tail, indicator and warning triangle. Used on Tipper trailers (TT2515, TT3017 and TT3621).
- 9 **P07947 Multifunction Rear Lamp.** Includes number plate illumination, stop/ tail, indicator, fog and warning triangle. Used as Left hand lamp on Export (right hand traffic) Tipper trailers (TT2515, TT3017 and TT3621) and as a Right hand lamp on Eurolight trailers (pre 2012).
- 11 **P07978 Multifunction Rear Lamp.** Left hand, includes number plate illumination, stop/ tail, indicator, reverse and warning triangle. Used on Tipper trailers (TT2515, TT3017 and TT3621).
- 9 **P07979 Multifunction Rear Lamp.** Includes number plate illumination, stop/tail, indicator, reverse and warning triangle. Used as Right hand lamp on Export (right hand traffic) Tipper trailers (TT2515, TT3017 and TT3621).
- 12 **P07990 Multifunction Rear Lamp.** Right hand, includes fog, stop/ tail, indicator and built in warning triangle.
- 13 **P07991 Multifunction Rear Lamp.** Left hand, includes fog, stop/ tail, indicator and built in warning triangle.
- 14 **P07997 Multifunction Rear Lamp.** Left hand, includes reverse, stop/ tail, indicator and built in warning triangle.
- 9 **P1875 Multi LED Rear Lamp.** Right hand, Includes reverse, stop / tail and indicator. Fitted as an LED option to the Beavertail range.**
- 15 **P1876 Multi LED Rear Lamp.** Left hand, Includes fog, stop / tail and indicator. Fitted as an LED option to the Beavertail range.**

MULTIFUNTION REAR LENSES

- 9 **P07943L Multifunction Rear Lens.** Compatible with P07943.
- 9 **P07944L Multifunction Rear Lens.** Compatible with P07944.
- 9 **P07946L Multifunction Rear Lens.** Compatible with P07946, P07947 & P07978.
- 9 **P07990L Multifunction Rear Lens.** Compatible with P07990.
- 9 **P07991L Multifunction Rear Lens.** Compatible with P07991.

** Some vehicles present so far insoluble problems when coupled to a trailer with LED lights. This may take the form of the hazard warning lights flashing continuously and there may be other problems too. Many other vehicles perform faultlessly when connected to LED equipped trailers. However, where such problems do occur, these are vehicle problems and Ifor Williams Trailers will not be responsible for their resolution. Owners are strongly advised to make thorough checks with the vehicle manufacturer before buying or specifying LED trailer lights.





FOG LAMPS

- 1 P0654 Fog Lamp.**
- P06541 Fog Lamp.** Supplied with longer length of cable.
- 2 P06781 Fog Lamp.** Rubber bodied fog lamp.
- P067811 Fog Lamp.** Rubber bodied fog lamp with 4.6m of cable. Fitted to the GH & TB ranges
- 3 P07945 Fog Lamp.** Surface mounted, includes feed plug & cable for use with P07966 lamp.
- 4 P07985 Fog Lamp.** Used on the BIAB, Eventa & TB ranges and being introduced.
- P079851 Fog Lamp.** LED with 2000mm cable. Available as an option for the TT & TB ranges.
- P1814 Fog Lamp.** Round, fitted to the current horsebox range.
- P1883 Mini LED Lamp.** Fog / reverse. Fitted as an LED option to the GX range.**
- 6 P1886-03 Mini LED Fog / Reverse Lamp.** 12/24v 0.3 m. Available as an LED option for the Flatbed range.**
- 7 P1886-15 Mini LED Fog / Reverse Lamp.** 12/24v 1.4 m. Available as an LED option for the Flatbed range.**
- P1886-50 Mini LED Fog / Reverse Lamp.** 12/24v 5.0 m. Fitted to the GH range from June 2016.**

FOG LAMP LENSES

- 8 P0707 Fog lamp lens.** Compatible with P0654 & P06541.
- 9 P06770/F Fog Lamp Lens.** Compatible with the single, 2 & 3 pod rubber bodied lamps.
- 10 P07945L Fog lamp Lens.** Compatible with P07945.

REVERSE LAMPS

- 11 P07986 Reverse Lamp.** Used on the BIAB, Eventa & TB ranges and being introduced to the CT177 during 2016.
- P079861 Reverse Lamp LED with 2000mm cable.** Available as an option for the TT & TB ranges.
- 12 P1827 Reverse Lamp.** Round, fitted to the current horsebox range.
- 13 P1850 Reverse Lamp.** Square, rubber bodied Lamp. Fitted on the DP, Flatbed & GH ranges.
- 14 P1852 Reverse Lamp.** Rectangular lamp with screw in lens.
- 15 P1853 Reverse Lamp.** Square lamp with 4metres of cable complete with 2 spades. Fitted to the Boxvan, HB610, P6/ P8G, TA5G & TA510G.

REVERSE LAMP LENSES.

- 16 P06770/C Reverse Lamp Lens.** Compatible with P1850
- 17 P1852-L Reverse Lamp Lens.** Compatible with P1852.

NUMBERPLATE LAMPS

- 18 P0667 Numberplate Lamp.** Supplied with 1 metre of cable.
- P06671 Numberplate lamp.** Supplied with longer length of cable. Fitted to the Beavertail, CT115, 136, CT177, P6/8G, TA5G & TA510G.
- 19 P06772 Numberplate Lamp.** Rubber bodied lamp. Fitted to the DP, Flatbed & HB510XL.
- 20 P06780 Numberplate Lamp.** Rubber Bodied lamp. Short cable. Fitted to the Flatbed range.
- P06781 Numberplate Lamp.** Rubber Bodied lamp. Long cable. Fitted to the Flatbed range.
- 21 P07951 Numberplate Lamp.** Fitted to the GD, GP, GX, TB & Unbraked ranges.
- 22 P0796LED Numberplate Lamp.** LED Fitted to the Beavertail, BIAB & Eventa ranges as standard and as an LED option for the Flatbed range. **
- 23 P1894-50 Numberplate lamp.** LED 12/24v 5.0m. Fitted to the GH range from June 2016.**
- 24 P1848 Numberplate Lamp.** Supplied with 0.7m of cable. Fitted to the CT166 & CT167.
- 25 P1849 Numberplate Lamp.** Supplied with 2 metres of cable. Fitted to the current Boxvan range.

NUMBERPLATE LENSES

- 26 P0667C Numberplate Lamp Casing.** Compatible with P0667 & P06671.
- 27 P0668 Numberplate lens.** Compatible with P0667 & P06671.
- 28 P06772/1 Numberplate Lens.** Compatible with P06772.
- 29 P07951L Numberplate Lens.** Compatible with P07951.

** Some vehicles present so far insoluble problems when coupled to a trailer with LED lights. This may take the form of the hazard warning lights flashing continuously and there may be other problems too. Many other vehicles perform faultlessly when connected to LED equipped trailers. However, where such problems do occur, these are vehicle problems and Ifor Williams Trailers will not be responsible for their resolution. Owners are strongly advised to make thorough checks with the vehicle manufacturer before buying or specifying LED trailer lights.



FRONT POSITION & OUTLINE MARKER LAMPS

P0653 Front Position lamp.

1 P06530 Front Position Lamp. Supplied with a longer length of cable.

2 P06773 Front Position Lamp. Rubber Bodied Lamp with integral reflector. Supplied with 2.5 metres of cable coloured for RH function. Fitted to The DP range.

P06774 Front Position Lamp. Rubber Bodied Lamp with integral reflector. Supplied with 2.5 metres of cable coloured for LH function. Fitted to The DP range

3 P06773B Front Position Lamp & Bracket. Rubber Bodied Lamp with integral reflector. Supplied with 2.5 metres of cable coloured for RH function. Fitted to the Beavertail, CT166 /167, HB510XL, HB610 & Flatbed range.

P06774B Front Position Lamp & Bracket. Rubber Bodied Lamp with integral reflector. Supplied with 2.5 metres of cable coloured for LH function. Fitted to the Beavertail, CT166 /167, HB510XL, HB610 & Flatbed range.

4 P06785 Front Position Lamp. Rubber Bodied Lamp with integral reflector. Supplied with 1.3 metre of cable coloured for RH function.

P06786 Front Position Lamp. Rubber Bodied Lamp with integral reflector. Supplied with 1.3 metre of cable coloured for LH function.

5 P06787 Front Outline Marker Lamp. Mounts directly onto the roof channel on the TA510G. Supplied with 5 metres of cable coloured for RH function.

P06788 Front Outline Marker Lamp. Mounts directly onto the roof channel on the TA510G. Supplied with 5 metres of cable coloured for LH function.

6 P0699 Front Position Lamp. LED Fitted to the TB range as standard and to the Beavertail and Flatbed range as an option.**

7 P07940 Front Position Lamp. Incorporating reflector, pre-fitted to a multi-positional fitting bracket. Fitted to the Unbraked range.

8 P07942 Front Position Lamp. In tough rubber housing.

9 P07942LED Front Position Lamp. 12/24v LED. Fitted to the CT136, CT177, GD, GP, GH4 and GX ranges.**

P07942LED-12 Front Position Lamp. 12/24v LED. Supplied with 1.2 metre of cable. Fitted to the GH1054.**

P07949LED-46 Front Position Lamp. LED supplied with 6.4 metres of cable. Fitted to the current Tipper range.**

10 P1811LED Front Position Lamp LED. Fitted to the current Horsebox range.

11 P18111 Front Position Lamp. Fitted to the BIAB & Eventa range.

FRONT POSITION & OUTLINE MARKER LENSES

12 P0706 Clear Lens. Compatible with P0653 7 P06530.

13 P06773/1 Clear Lens. Compatible with P06773, P06773B, P06774 & P06774B.

14 P067851 Clear Lens. Compatible with P06785 & P06786.

15 P067871 Clear Lens. Compatible with P06787 & P06788.

16 P07940L Clear Lens. Compatible with P07940 & P07942.

** Some vehicles present so far insoluble problems when coupled to a trailer with LED lights. This may take the form of the hazard warning lights flashing continuously and there may be other problems too. Many other vehicles perform faultlessly when connected to LED equipped trailers. However, where such problems do occur, these are vehicle problems and Ifor Williams Trailers will not be responsible for their resolution. Owners are strongly advised to make thorough checks with the vehicle manufacturer before buying or specifying LED trailer lights.





REAR POSITION & SIDE OUTLINE MARKER LAMPS

- 1 P06531 Amber Side Marker Lamp**
- 2 P0652/84 Outline Marker Lamp.** For Front or rear mounting, supplied with clear and blank lenses and 2.1 metres of cable. Fitted to the BV6.
- 3 P0657A Outline Marker Lamp.** Surface mounted stalk lamp with red and black lenses. Fitted either up or down hand positioning.
- P0657B Outline Marker Lamp.** Surface mounted stalk lamp with red and black lenses. Fitted either up or down hand positioning.
- 4 P0657L Outline Marker Lamp.** LH surface mounted stalk lamp with red and clear lenses. Fitted to the HB510XL & HB610.
- P0657R Outline Marker Lamp.** RH surface mounted stalk lamp with red and clear lenses. Fitted to the HB510XL & HB610.
- P06576R Outline Marker Lamp.** RH. Fitted to the CT115 & CT136.
- P06577L Outline Marker Lamp.** LH. Fitted to the CT115, CT136 & CT177.
- P06577R Outline Marker Lamp.** RH. Fitted to the CT177.
- P06782B Side Marker Lamp.** Rubber Bodied lamp with amber lens.
- 5 P06787/R Rear Outline Marker Lamp.** RH with red lens, fitted to the TA510G and LM7.
- 6 P06788/R Rear Outline Marker Lamp.** LH With red lens, fitted to the TA510G and LM7.
- 7 P06991 Side Marker Lamp LED.** Fitted to the TB range as standard and as an option on the Beavertail & Flatbed (16', 18' long) range.
- 8 P06993 Rear Marker Lamp LED.** Fitted when LED lights are specified to the Beavertail and Flatbed range (7' wide trailers).
- 9 P07941LED Side Marker Lamp.** LED. Supplied with 0.8 metre of cable. Fitted to the CT177 & GP ranges.**
- 10 P07960 Rear Outline Marker Lamp.** RH Stalk lamp with clear, red and amber segments. Fitted to the GD6, GP & GX106.
- P07961 Rear Outline Marker Lamp.** LH Stalk lamp with clear, red and amber segments. Fitted to the GD6, GP & GX106.
- 11 P1818 Outline Marker Lamp.** Fitted to the BIAB, Eventa and HB511.



REAR POSITION & SIDE OUTLINE MARKER LENSES

- 12 P0705 Red Lens.** Compatible with P0652/84, P0657A, P0657B, P0657L, P0657R, P06577L & P06577R.
- P0706 Clear Lens.** Compatible with P0652/84, P0657A, P0657B, P0657L, P0657R, P06577L & P06577R.
- P0659 Blanking Lens.** Compatible with P0652/84, P0657A, P0657B, P0657L, P0657R, P06577L & P06577R when only one function is required.
- 13 P06782/1 Amber Lens.** Compatible with P06782B
- 14 P067872 Red Lens.** Compatible with P06787/R & P06788/R.
- 15 P07960L Clear, Amber & Red Lens.** Compatible with P07960 & P07961.



** Tests carried out by the company show that some common vehicles present so far insoluble problems when coupled to a trailer with LED lights. This may take the form of the hazard warning lights flashing continuously and there may be other problems too. Many other vehicles perform effortlessly when connected to LED equipped trailers. However, where such problems do occur, these are vehicle problems and Ifor Williams Trailers will not be responsible for their resolution. Owners are strongly advised to make thorough checks with the vehicle manufacturer before buying or specifying LED trailer lights.



REFLECTORS

- 1** P0661 Rear Triangular Reflector.
- 2** P0691 Round Amber Side Reflector.
P0691A Round Amber Side Reflector. Self adhesive, fitted to the BV, GH, Livestock & Q range.
- 3** P0696 Rectangular Amber Side Reflector.
P0696A Rectangular Amber Side Reflector. Self adhesive. Fitted to the TB range.
- 4** P1820 Round Amber Side Reflector. 60mm diameter, fitted to the current Horsebox range.
- 5** P1821 Rear Triangular Reflector. Fitted to the current Horsebox range.
- 6** P1829 Round Triangle Reflector. Fitted to the BIAB and Eventa ranges.

INTERIOR LAMPS

- 7** P06790 Interior Lamp. Fitted to the Livestock range.
- 8** P07969 Interior Lamp. Fitted to the unbraked range.
- 9** P1817 Interior Lamp. Fitted to the BIAB, Eventa and current Horsebox range.

LIGHTING KITS

- 10** P06841-13UK Lighting Kit. Fitted to the BV64e, P6b, P6e, P7b, P7e & Q6 road.
- P06842-13UK Lighting Kit. Fitted to the P8b, P8e, Q7 road & Q8.
- P06843-13UK Lighting Kit. Fitted to the P5e & Q5 road.
- P07980-13UK Lighting Kit. Supplied with 7.5m harness. Fitted to the EL142-3615 & EX202-3615 Eurolight ranges.
- P07981-13UK Lighting Kit. No front position lamps, supplied with 6.5m harness. Fitted to the unbraked, EL101-2012 & 2515 & EL142-2515 Eurolight ranges.
- P07982-13UK Lighting Kit. Supplied with 6.5m harness. Fitted to the EL101-2515, EL141-2515, EL142-2515 & 3015 & EX202-2515 & 3015 Eurolight ranges.





AS8383 7 Core Lighting Cable. Supplied with a 7 pin plug at both ends.

1 AS8384 8 Core Lighting Cable. Supplied with a 13 pin plug at both ends.

2 P0738 7 Core Coiled Cable. Supplied with a 7 pin plug at one end and spade connectors at the other end.

P0738-13 8 Core Coiled Cable. Supplied with a 13 pin plug at one end and spade connectors at the other end.

3 P0739T-13 8 Core Coiled Cable. Supplied with a 13 pin plug at one end. Fitted to the DP120, GH range, HB610, P6/8G, TA5G & TA510G.

4 P1806 13 Pin Plug.

5 P1807 13 Pin Socket.

P1809 8 Core Electrical Cable. Sold per metre

6 P1810-13G1S1 8 Core Coiled Cable. Supplied with a 13 pin plug at one end and spade connectors at the other end. Fitted to the current Horsebox range.

P1810-13 8 Core Coiled Cable. Supplied with a 13 pin plug. Fitted to the TT2515 & TT3017.

P1808-13 8 Core Coiled Cable. Supplied with a 13 pin plug. Fitted to the TT3621.

7 P1815 Wiring Loom. RH, fitted to the current Horsebox range.

8 P1816 Wiring Loom. LH, fitted to the current Horsebox range.

9 P1860 Wiring Harness. 3.5m length of cable with 13 pin socket and provision for R/H fog and L/H reverse. Fitted to the GD4 range.

P1861 Wiring Harness. 4.5m length of cable with 13 pin socket and provision for R/H fog and L/H reverse. Fitted to the GD5 & GX84 ranges.

P1862 Wiring Harness. 5.5m length of cable with 13 pin socket and provision for R/H fog and L/H reverse. Fitted to the GD6, GP106, GP126, GX5 & GX6 ranges.

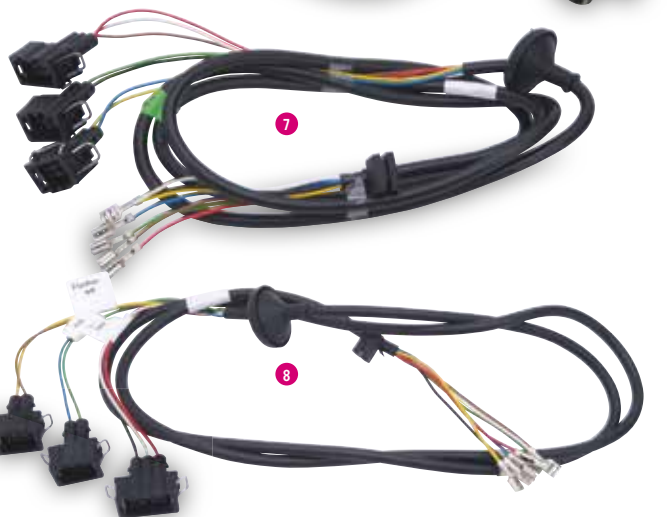

LIGHTING ACCESSORIES

10 B0085 Bulb Set. Contains a mix of bulbs including brake, indicator, stop/ tail, numberplate and side lamps.

11 F1932PK Cable Clips. Pack of 25. To hold the electrical cable in place along the trailer chassis.

P06624-7-13 Adaptor. Enabling the 7 pin plug from a trailer to be fitted to a vehicle with a 13 pin socket.

12 P06625-7-13 Adaptor. Enabling the 13 pin plug from the trailer to be fitted to a vehicle with a 7 pin socket.

13 P07255 Aqua Safe Plug & Socket. Used on the DP range to disconnect the lighting system when removing the container.

14 P07993 Number Plate Holder. Long, allows for number plates to be easily changed.

15 P07994 Number Plate Holder. Square, allows for number plates to be easily changed.

16 P1024 Cable Clip. Used to secure the lighting cable on the front panel when not in use.



Model of Trailer	Front Marker Lamp RH	Front Marker Lamp LH	Side Marker Lamps	Rear Lamp RH	Rear Lamp LH	Rear Marker Lamp	Fog Lamp	Number Plate Lamp	Reverse Lamp	Interior Lamp	Lighting Cable / Harness
Beavertail 6series	P06773B	P06774B		P1870	P1871			P06671			P0738-13
Beavertail 7 series	P0699	P0699		P1875	P1876	O06993		P0796LED			P0738-13
Box Van 4 & 5 series	P06785	P06786		P06691/R	P06691/L		P07945	P06772	P1853	P06775	P0738-13
Box Van 6 series	P06785	P06786	P0652/84	P06691/R	P06691/L		P07945	P1849 Roller Shutter P06772 Ramp Door	P1853	P06775	P0738-13
BIAB / Eventa	P18111	P18111		P07983 Stop / tail P07984 Indicator P07985 Fog	P07983 Stop / tail P07984 Indicator P07985 Fog	P1818		P0796LED	P07986	P1817	P4399
CT115, CT136	P07942LED	P07942LED		P067836	P067841	P06576R P06577L	P07945	P0667 P06671	P1853		P0738-13
CT177	P07942LED	P07942LED	P07941LED	P06783	P067841	P06577R P06577L	P07945	P06671	P1853		P0738-13
CT166 & CT167	P06773B	P06773B	P06782B	P1870	P1871				P1848		
Flatbed 5 series	P06773B	P06774B		P06783	P06784		P06781	P06772 P06780 - SHORT	P1850		P0739T-13
Flatbed 6 series	P06773B	P06774B		P06778	P06779		P06781	P06772 P06780 - SHORT	P1850		P0738-13
Flatbed 7 series				P06778	P06779	P06787/R P06788/R	P06781	P06772 P06780 - SHORT	P1850		P0738-13
GD4 series	P07942LED	P07942LED		P07990	P07997			P07951			AS8384
GD5 series	P07942LED	P07942LED		P07990	P07997			P07951			P1861
GD6 series	P07942LED	P07942LED		P07990	P07997	P07960 RH P07961 LH		P07951			P1862
GP106 / 126 / 127	P07942LED	P07942LED		P07990	P07997	P07960 RH P07961 LH		P07951			P1862
GP146 / 147	P07942LED	P07942LED	P07941LED	P07990	P07997	P07960 RH P07961 LH		P07951			P1863
HB series	P1811LED	P1811LED		P1812 Stop / tail P1813 Indicator	P1812 Stop / tail P1813 Indicator	P1818	P1814	P1822	P1827	P1817	P1810-13G1S1
HB510XL	P06773B	P06774B	P0657L P0657R	P06770	P1851			P06772		P06790	P0739T-13
HB610	P06773B	P06774B	P0657L P0657R	P06778A	P06778A		P07945	P0667	P1853	P06790	P0739T-13
P6 & P8G Series	P06785	P06786		P0669	P0669		P07945	P06671		P06790	P0739T-13
TA5G Series	P06785	P06786		P06691/R	P06691/L		P07945	P06671	P1853	P06790	P0739T-13
TA510G Series	P06785	P06786	P06787 - RH P06788 - LH	P06691/R	P06691/L	P06787/R - RH P06788/R - LH	P07945	P06671	P1853	P06790	P0739T-13
DP120 Series	P06773	P06774B		P06778	P06779		P06781	P06772 P06780 - SHORT	P1850	P06790	P0739T-13
GX84	P07942LED	P07942LED		P07990	P07997			P07951			P1861
GX5 / 6	P07942LED	P07942LED		P07990	P07997			P07951			P1862
GH 4 Series	P07942LED	P07942LED		P067781	P067791		P067811	P067801	P1850		AS8384
GH1054 Series	P07942LED-12	P07942LED-12		P067781	P067791		P067811	P067801	P1850		AS8384
New lamps introduced mid 2016 for the GH series								P1886/50	P1894-50		
TB 4m	P0699	P0699		P07983 Stop / tail P07984 Indicator	P07983 Stop / tail P07984 Indicator		P07985	P07951	P07986		P0738-13
TB 4.6m / 5m / 5.5m	P0699	P0699	P06991	P07983 Stop / tail P07984 Indicator	P07983 Stop / tail P07984 Indicator		P07985	P07951	P07986		P0738-13
TT2515 & TT3017	P07949-LED-46	P07949-LED-46		P07946	P07978						P1810-13
TT3621	P07949-LED-46	P07949-LED-46		P07946	P07978						P1808-13

Winches

Manual & Electric winches & Kits



Contents

	Page
Winches – General Information and Capacity	76
Electric and Manual Winch Kits and Brackets	77
Superwinch S5500 & spares	78
Mechanical braked winches 2000kg & 3000kg	79 & 81
Mechanical braked winch spares	80 & 81
Fulton automatic braked winches	80

Trailers with winches

We recommend that you use only Ifor Williams Trailers supplied winches on our trailers as these are specified to be compatible with the winch brackets. Other makes of winch may not be compatible and any resulting damage to the trailer or bracket may invalidate warranty.

All winch brackets and winches are designed and rated to be used with rolling loads. They are not intended for use with vehicles where the wheels do not freely rotate. Manually operated and electrical winches can be fitted to a number of Ifor Williams Trailers trailer ranges including car transporters; tiltbed trailers; flatbed trailers; tipping trailers; GD trailers and plant trailers.

Some winch designs have an integral bracket permitting direct attachment to the trailer. In other cases a range of winch brackets are available which are model-specific to permit fitment of the winch.

Winch Capacity

Different winch manufacturers specify the capacity of the winch in different ways sometimes making it difficult to make comparisons. Ifor Williams Trailers has converted the winch supplier's information into a standard format taking account of the maximum incline of the ramp/skid or tiltbed attainable with that trailer range.

In the table below the figure in each box is the maximum weight of a rolling load that can be winched onto that trailer/ ramp combination. In many cases the winch capacity exceeds that of the trailer and or ramp/skid.

YOU MUST NEVER EXCEED THE MAXIMUM PAYLOAD OF THE TRAILER OR ITS RAMP/SKID (Whichever is lower).

Refer to the trailer's COC (Certificate of Conformity) for the trailer's payload.



WINCH CAPACITY TABLE

IWT PART REFERENCE	MAX LINE PULL IN kg	CCT5221	CT115 CT136* CT136HD	CT177	LT / LM	CT 166/67TILT BED	GD	GP	GX	GH	TB	TT
P04705	270kg	-	400kg	-	-	-	-	-	-	-	-	-
P04706	480kg	-	1000kg	-	-	-	-	-	-	700kg	-	-
P04707	680kg	-	1400kg	-	-	-	-	-	-	-	1200kg	-
P04685B STRAP	500kg	-	-	-	1300kg	-	1300kg	-	-	-	-	-
P04703 CABLE	1000kg	-	-	>3000kg	2500kg	-	2600kg	2500kg	-	-	>3000kg	-
P04702	1000kg	-	-	>3000kg	-	-	-	-	-	-	-	-
P0980 ELECTRIC	2500kg	>3000kg	-	>3000kg	>3000kg	>3000kg	>3000kg	>3000kg	>3000kg	-	>3000kg	>3000kg

ELECTRIC WINCH KITS

Part Code	Description	Parts included in kit	Compatible with
KX6141-15	Winch, Bracket & power lead kit.	S5500 Superwinch, mounting bracket & power leads to connect to trailer battery (If Fitted).	TT2515
KX6141-17	Winch, Bracket & power lead kit.	S5500 Superwinch, mounting bracket & power leads to connect to trailer battery.	TT3017
KX6141-21	Winch, Bracket & power lead kit.	S5500 Superwinch, mounting bracket & power leads to connect to trailer battery.	TT3621
KX6154	Winch & Power Lead Kit	S5500 Superwinch, 6.3m Powerlead kit and all fittings to power the winch from the vehicle battery.	CT177G
KX6155	Winch, Battery & Bracket Kit	S5500 Superwinch, battery, mounting bracket and all fittings.	CT177G
KX6171	Winch, Bracket & Powerlead Kit	S5500 Superwinch, winch mounting bracket, power leads to connect to vehicle battery, jockey wheel & spare wheel bracket.	Flatbed & Beavertail Ranges
KX6172	Winch, Bracket & Battery	S5500 Superwinch, winch mounting bracket, battery, battery mounting bracket, jockey wheel & spare wheel bracket.	Flatbed & Beavertail Ranges
KX6218-21	Winch, Bracket & Battery Kit	S5500 Superwinch, battery, mounting bracket and all fittings.	TB Range mk1 & mk2
KX6219-21	Winch, Bracket & Powerlead Kit	S5500 Superwinch, mounting bracket, power leads to connect to vehicle battery.	TB Range mk1 & mk2

MOUNTING BRACKET AND BATTERY KITS

Part Code	Description	Parts included in kit	Compatible with
KX6142-15	Winch Mounting kit.	Mounting bracket.	TT2515
KX6142-17	Winch Mounting kit.	Mounting bracket.	TT3017
KX6142-21	Winch Mounting kit.	Mounting bracket.	TT3621
AS5405	Winch Mounting Bracket	Mounting bracket.	Flatbed Range
KX6169	Winch Mounting Bracket Kit	AS5405 Mounting bracket. AS5539 Spare wheel bracket. P0475H Jockey Wheel.	Beavertail Ranges
KX6198-21	Winch, Mounting Bracket	Mounting bracket.	TB Range mk1 & mk2
KX216-21	Battery Carrier	Battery carrier, isolating switch, electrical cable & fittings.	TB Range mk1 & mk2
KX6199-21	Battery Mounting Kit	Battery, battery carrier, isolating switch, electrical cable & fittings.	TB Range mk1 & mk2

MANUAL WINCH & BRACKET KITS

Part Code	Description	Parts included in kit	Compatible with
KX35311	Manual Winch Kit	P04706 winch, mounting tube & bracket.	GH64
KX35321	Manual Winch Kit	P04706 winch, mounting tube & bracket.	GH94, GH94BT & GH1054
KX6126	Manual Winch Kit	P04703 winch and mounting bracket.	GP146H
KX6128	Manual Winch Kit	P04703 winch and mounting bracket.	GP106H & GP126H
KX6160	Manual Winch Kit	P04685B winch, AS5539 spare wheel bracket & P0475H jockey wheel.	Flatbed and Beaver Tail ranges
KX6165	Manual Winch Kit	P04680B winch, AS5539 spare wheel bracket & P0475H jockey wheel.	Flatbed and Beaver Tail ranges

MANUAL WINCH MOUNTING BRACKETS

Part Code	Description	Compatible with
KX6066	Winch Mounting & Support Bracket GD4	The P04685B winch for the GD4M range of trailers.
KX6067	Winch Mounting & Support Bracket GD5	The P04685B winch for the GD5M range of trailers.
KX60675	Winch Mounting & Support Bracket GD5	The P04680B winch for the GD5M twin axle range of trailers.
KX6068	Winch Mounting & Support Bracket GD6	The P04685B winch for the GD6M range of trailers.
KX60685	Winch Mounting & Support Bracket GD6	The P04680B winch for the GD6M range of trailers.
KX5525	Winch Mounting Bracket CT115	The P04705, P04706 & P04707 Fulton winches for the CT115 range of trailers.
KX5528	Winch Mounting Bracket CT136	The P04705, P04706 & P04707 Fulton winches for the CT136 range of trailers.
KX6198-21	Winch Mounting Bracket Kit	The P04702 & P04703 on the TB range.



Superwinch S5500 Electrical Winch

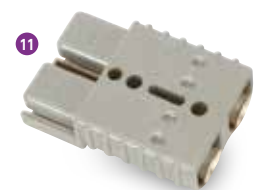
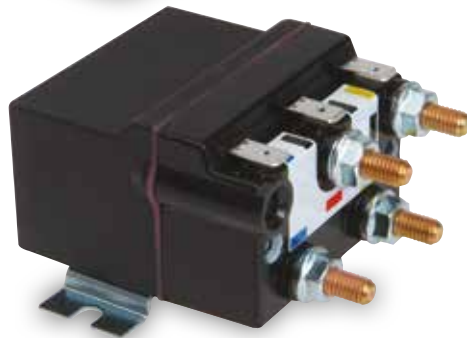
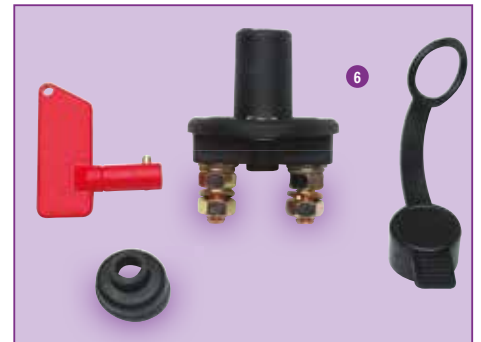

- 1 P0980 Superwinch S5500.** 2500kg (5,500lb) line pull with 3 stage planetary gearing, sealed and breaker protected solenoid, 100% load holding brake, 7.1mm x 18.3m cable with heavy duty clevis pinned hook, 30' long remote control.
- 2 P09801 Wire Rope & Hook Assembly.**
- 3 P09802 12v Motor.**
- 4 P09803 Remote Control.**
- 5 P09804 12v Solenoid.**
- 6 P0670 Isolator Switch.** Battery isolator supplied with one removable key.
- 7 P0670A Isolator Key.** Spare key for isolator switch.
- 8 P0728 Cable Terminal.** 10mm hole for 16mm electrical cable.
- P0660 Cable Terminal.** 8mm hole for 16mm electrical cable.
- 9 P0733 Cable Red.** 16 square mm cross sectional area for wiring winches and other heavy duty accessories. Sold per metre.
- 10 P0734 Cable Black.** 16 square mm cross sectional area for wiring winches and other heavy duty accessories. Sold per metre.
- 11 P1127 Connector.** 2 pole 175amp grey. Used within the powerlead kits.

Mechanical braked Winches 2000kg* & 3000kg*

Ifor Williams
Parts

WINCHES

Introduced during
2015, these winches
are identifiable by the
electro plated body

2000kg* Rating
Now with automatic
braking!

3000kg* Rating
Now with automatic
braking!

1 P04680B 3000kg * Mechanical Winch.

2 P04685B 2000kg * Mechanical Winch.

Features

Specifically designed to bolt vertically to the Flatbed & GP range and onto the GD range with the addition of a mounting bracket. The winches are fitted with an automatic brake that will hold the load if the operator were to release the handle. Fitted with a 12 metre long, 8mm diameter wire rope with an eye hook.

*Please refer to the winch capacity information on page 76





2000kg WINCH SPARES

- 1 P0468-PAR002 Hook Drum.
- 2 P0468-PAR005 Handle & Knob.
- 3 P0468-PAR007 Drive Shaft.
- 4 P0468-PAR010 Idler Shaft.
- 5 P0468-PAR013 Rope & Hook .



3000kg WINCH SPARES

- 6 P0468-PAR001 Hook Drum.
- 7 P0468-PAR004 Double Gear.
- 8 P0468-PAR006 Handle & Knob.
- 9 P0468-PAR008 Drive Shaft.
- 10 P0468-PAR009 Idler Shaft.
- 11 P0468-PAR014 Rope & Hook .



2000kg & 3000kg COMMON WINCH SPARES

- 12 P0468-PAR011 Double Ratchet
- 13 P0468-PAR016 Brake Pad.
- 14 P0468-PAR017 Black Knob.



**3000kg* Braked
Mechanical winches**
Bolt Horizontally to the standard
bracket of the CT177



- 1 P04702** 3000kg* Mechanical Winch. Fitted with a webbing strap.
- 2 P04703** 3000kg* Mechanical Winch. Fitted with an 8mm diameter, 12m long galvanised rope with eye hook.
- KX4703** 3000kg* Mechanical Winch & Support Angle. This kit consist of P04703 winch, support angle & fittings, required when fitting to the CT177 Standard bracket.

WINCH SPARES

- 3 P0468-PAR003** Strap Drum. For the P04702 winch.
- 4 P0468-PAR001** Hook Drum. For the P04703 winch.
- 5 P0468-PAR004** Double Gear. For the P04702 & P04703 winches.
- 6 P0468-PAR006** Winch Handle & Knob. For the P04702 & P04703 winches.
- 7 P0468-PAR009** Winch Idler Shaft. For the P04702 & P04703 winches.
- 8 P0468-PAR012** Double Ratchet. For the P04702 & P04703 winches.
- 9 P0468-PAR015** Strap & Hook. For the P04702 winch.
- 10 P0468-PAR014** Rope & Hook. For the P04703 winch.
- 11 P0468-PAR016** Brake Pad. For the P04702 & P04703 winches.
- 12 P0468-PAR017** Black Knob. For the P04702 & P04703 winches.

* Please refer to the winch capacity information on page 76

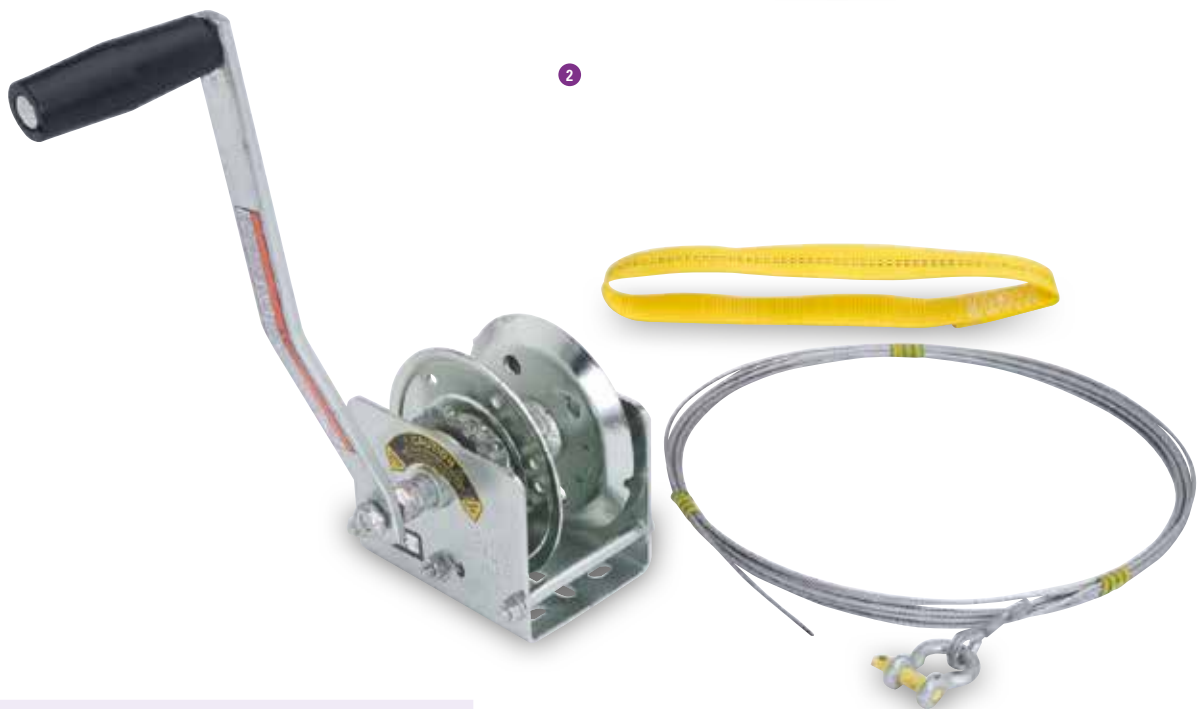

1 P04705 Fulton Circuit Winch. 272kg* (600lb). Compatible with the CT115 & CT136.

2 P04706 Fulton Rally Winch. 476kg* (1050lb). Compatible with the CT115, CT136 & GH Series.

P04707 Fulton Recovery Winch. 680kg* (1500lb). Compatible with the CT115, CT136 & TB series.

All winches are supplied with a wire rope with U clamp attached and a soft link strap, the P04707 is also supplied with a hook.

The brake design allows the load to be wound out under full control with the minimum of effort. No minimum load is required to activate the brake or wind the cable off the drum.

Designed with heavy gauge material, wide gear contact and thick zinc plating.

A winch mounting kit is available for the GH, CT115 & CT136 ranges allowing the winch to be mounted in the left and right positions. Very easy removal allows the winch to be stowed securely when not required.

* Please refer to the winch capacity information on page 76

Model Specific

Large cross division Page 105

Dedicated accessories for Livestock • Horsebox
• Box Van • Commercial Trailers



Ramp gate extensions Page 109

Horsebox HB403, HB506 & HB511 Page	General Duty Page	GX Range Page
Mudguard & Rear Lamp Housing 84	Tailboards, Ramps, Ladder Racks, Body Panels & Mesh Sides 111	GX106 – Chassis & Body Components, Ramp & Skid Installation 130
HB511 Centre Partition & Spares 85	Flatbed Range Page	GX125HD & GX126 – Chassis & Body Components, Ramp & Skid Installation 131 & 132
HB506 Centre Partition & Spares 86	Dropside Kits & Components 112	GP Range Page
Seals, Glazing, Kickboards & Padding 87	Headboards, Tailboards, Ladder Racks, Ramps & Loading Skids 113	Aluminium Mudguards, Loading Skids, Ramps & Mesh Kits 133
Ramp & Rear Door Spares 88	Hinged Mesh Kits & Components 114	GH Range Page
Doors above the Front Ramp & Inspection Door Kits 89	Drawbars, Suspension Cross Members & Lighting Plates 115	Ramp & Skid Kits, Accessories & Dedicated Spares 134
Front Panel Kits, Roof Kits, Top Side Panels, Pillars and Flooring 90	Eurolight Page	Car Transporter Range Page
Tack Storage & Accessories 91	Dropside Kits, Mesh Kits & Accessories 116	CT177 – Drawbar, Coupling Spares, Loading Skids, Hydraulics, Body Components & Winch Mounting 135
Trailer Covers 92	Beavertail Page	CT115 & CT136 – Accessories & Unique Spare Parts 136
Horsebox HB401, HB505 & HB510 Page	Dropside Kits, Mesh Kits, Headboards, Ladder Racks & Ramps 117	Box Van Range Page
HB510 Centre Partition & Spares 93	Tiltbed Page	Body & Roof Panels & Inspection Door Fittings 137
HB505 Centre Partition & Spares 94	CT166 & CT167 – Dropside Kits, Mesh Kits, Manual Pump & Hydraulics 118	Rear Ramp, Van Door & Roller Shutter Fittings 138
Ramp & Door Fittings, Glazing & Seals 95	TB Range – Dropside Kits, Mesh Kits, Ramps, Skids & Tailboards 119	Inspection Door Kits & Rear Protection Brackets 139
Flooring & Matting 96	TB Range – Dedicated Spares 120	P*b Range Page
Body Components 97	Tipper Trailers Page	Dedicated Kits, Accessories, Body Components, Ramp & Tailboard Spares 140
Large Horsebox HB510XL & HB610 Page	TT2515, TT3017 & TT3621 – Mesh & Solid Side Kits 121	Unbraked Trailer Range Page
Partition Kits, Body & Flooring Spares 98	TT2515, TT3017 & TT3621 – Dropsides, Headboards & Tailboards 122	PP6e & P7e- Dedicated Kits & Accessories, Body Panels & Spares 141
Eventa Page	TT2515, TT3017 & TT3621 – Accessories & Dedicated Spares 123	BV64BV64e & P5 – Dedicated Kits, Accessories & Spares 142
Living & Horse Area Spares 99	Hydraulic & Manual Pump Spares 124	P8e – P8e Dedicated Kits & Accessories, Body Panels & Spares 143
Centre Partition, Rear ramp & Body Components 100	Savery Hydraulic Power Pack 125	O Range Page
Livestock Page	TT85G, TT105G & TT126G – Dropsides, Mesh Kits & Dedicated Spares 126	Dedicated Kits & Accessories 144
Ramp Spares & Corner Pillars 101	SPX Fenner & Fluidlink Pump Spares 127	Canopies Page
Roof Sheets, Roof Channels & Body Panels 102	GX Range Page	Rear Doors, Canopy Accessories & Spares 145
Body Rails, Lighting Panels & Foot Plates 103	GX84 – Chassis & Body Components, Ramp & Skid Installation 128	
Centre Partition Kits 104	GX85 & GX105 – Chassis & Body Components, Ramp & Skid Installation 129	
Cross Divisions 105		
Cross Division Components 106		
Sheep Deck & Rear Barrier Components 107		
Rear Barriers 108		
Ramp Gates, Extensions & Back Rails 109		
Sump Tanks & GRP Wind Deflectors 110		



MUDGUARD AND REAR LAMP HOUSING

- 1 CP00321 Mudguard Twin Arch Sections. Fits either side.
- 2 CP00322 Mudguard Inner Section. Fits either side.
- 3 CP00324 Front Lamp Enclosure. Right Hand.
- 4 CP00323 Front lamp Enclosure. Left Hand.
- 5 CP00326 Rear Corner Bumper. Right Hand HB403, HB506.
- 6 CP00325 Rear Corner Bumper. Left Hand HB403, HB506.
- 7 CP00328 Rear Corner Bumper. Right Hand HB511.
- 8 CP00327 Rear Corner Bumper. Left Hand HB511.
- 9 CP00392 Rear lamp Bezel.
- 10 F1245PK Mudguard/Bumper Polymate Screws. Pack of 60.

WHEEL ACCESSORIES & SPARES

- 11 KX0835 Wheel Trim. To fit 13" wheels, supplied as a set of 4. Style of trim may vary from illustration.
- 12 F1830PK Wheel Bolts. 4 pack – Standard non locking.
- 13 KX9802 Locking Wheel Bolt Kit. M12 x 1.5 pitch with uniquely coded adapter and spider wheel wrench. Pack 4
- 14 KX0240 Wheel Chocks. 1 Pair. Recommended for use when uncoupling, parking, and in place of the handbrake when storing your trailer for a length of time.
- 15 KX0795 Lockable Spare Wheel Carrier. Now positioned at the rear of the trailer. Enables you to fit a padlock for security.
- 16 P0885/SVR Spare Wheel Cover Silver. Fits the HB403, HB506, HB511, HB401, HB505 & HB510.
- 17 P1256 Wheel Brace. 19mm, for removing wheel bolts and for use with the quick release mechanism on the breast bar receiver eye bolt.



HB511



- 1 WA00343 **Breaching Bar.** Half width for use with the centre partition.
- 2 KX0820 **Full width Breaching Bar.** For horses that prefer to travel in a wider stall. Centre partitions are removed and full width breast and breeching bars are fitted.
- 3 C31250 **Breast/Breeching Bar Receiver Bracket.** Fitted to the side wall of the trailer and to the partition leaves.
- 4 KS304714 **Partition Leaf Assembly.** (Front) Cream padding includes rubber skirt.
- 5 KS304514 **Partition Leaf Assembly.** (Rear) Cream padding includes rubber skirt.
- 6 C82544 **Partition Skirt.**
- 7 C00560 **Partition Holding Hook.**
- 8 WA00559 **Partition Mounting Pole.** For the HB511 mk2 (from May 2011 onwards)
- 9 CP00440 **Partition Mounting Pole Clevis Pin.**
- 10 F1913Z **Partition Mounting Pole R Clip.**
- 11 CP00441 **Partition Mounting Pole Clevis Spring.** Includes one accessory tube and all other fittings
- 12 KX0805 **Head Partition HB511.** Also includes lower accessory tube and fittings.
- 13 P1022 **Mini Tye.** 135mm Centres (Head Partition).
- 14 P1025 **Mini Tye.** 225mm Centres (Head partition).
- 15 C00130 **Fixing Pin for Head Partition.**
CP00447 **Accessory Tube.** For fitting head partition to the front panel.
- 16 F1103SVRPK **Breast Bar Retaining Washers.** (16 pack) silver.
- 17 F0932SVRPK **Socket Head Screw.** M8 x 35 (16 pack) Silver.
- 18 CP00436 **Eye Bolt.** M8 x 35mm Enables the release of breast bars safely from outside the trailer. Suits the wheel brace supplied with trailer.
- 19 P1278PK **Neoprene Washer.** 40mm washer used under the breast/breeching bar retainer washers.
- 20 P1260 **Allen Key 5mm.**
- 21 F1003ZPK **Hexagon Nut M8.** (Breast bar receivers – 20 pack).
- 22 F0923ZPK **Socket Screw.** M8 x 40 Cap Head. Used to secure the breast bar receiver bracket to the centre partition panel. Pack Qty 10.

HB506



- 1 WA00417 Breeching Bar. Half width for use with the centre partition.
- 2 KX0815 Full Width Breeching Bar. For horses that prefer to travel in a wider stall. Centre partitions are removed and full width breast and breeching bars are fitted.
- 3 C31250 Breast/Breeching Bar Receiver Bracket.
- 4 KS304814 Partition Leaf Assembly. (Front) Cream padding includes rubber skirt.
- 5 KS304614 Partition Leaf Assembly. (Rear) Cream padding includes rubber skirt.
- 6 C82543 Partition Skirt.
- 7 C00560 Partition Holding Hook.
- 8 WA00559 Partition Mounting Pole. For the HB506 mk2 (from May 2011 onwards)
- 9 CP00440 Partition Mounting Pole Clevis Pin.
- 10 F1913Z Partition Mounting Pole R Clip.
- 11 CP00441 Partition Mounting Pole Clevis Spring.
- 12 KX0800 Head Partition HB506. Includes two accessory tubes and all other fittings
- 13 P1022 Mini Tye. 135mm Centres (Head Partition).
- 14 P1025 Mini Tye. 225mm Centres (Head partition).
- 15 C00130 Fixing Pin for Head Partition.
- CP00447 Accessory Tube. For fitting head partition to the front panel.
- 16 F1103SVRPK Breast Bar Retaining Washers. (16 pack) silver.
- 17 F0932SVRPK Socket Head Screw M8 x 35. (16 pack) silver.
- 18 CP00436 Eye Bolt. M8 x 35mm enables the release of breast bars safely from outside the trailer. Suits the wheel brace supplied with trailer.
- 19 P1278PK Neoprene Washer 40mm. 40mm washer used under the breast/breeching bar retainer washers. Pack Qty 16.
- 20 P1260 Allen Key 5mm.
- 21 F1003ZPK Hexagon Nut M8. (Breast bar receivers - 20 pack).
- 22 F0923ZPK Socket Screw. M8 x 40 Cap Head. Used to secure the breast bar receiver bracket to the centre partition panel. Pack Qty 10.



HB403

WA00454 Breeching Bar HB403.



SEALS, CAPPING & DRAUGHT EXCLUDERS

- 1 P1300-1036 Front Upper Door Seal. Silver HB403, HB506. Cut to correct length.
- 2 P1300-1193 Front Upper Door Seal. Silver HB511. Cut to correct length.
- 3 P1311-00688 Rear Door Beading. (vertical) HB403, HB506. Cut to correct length.
- 4 P1311-00703 Rear Door Beading. (vertical) HB511. Cut to correct length.
- 5 P1304-01205 Rear Door Surround Rubber HB403. Cut to correct length.
- 6 P1304-01365 Rear Door Surround Rubber HB506. Cut to correct length.
- 7 P1304-01430 Rear Door Surround Rubber HB511. Cut to correct length.
- 8 P1802 Inspection Door Seal. Per metre.
- 9 ET00078-01200 Pillar Capping. (external-rear). Cut to correct length.
- 10 ET00078-0160 Pillar Capping. (external-front). Cut to correct length.

WINDOWS, VENTS & GLAZING PARTS

- 11 CP00304 Front Window. Fitted to HB506 & HB511.
- 12 KX4325 Front Window Guard Kit. For the HB506 & HB511 mk2. The kit comprises of 1 guard, stiffener and rivets. Distributor supply & fit only.
- KS2278 Fixed Window Kit. (front top door) includes glass and rubber seal.
- 13 CP00281 Safety Glass. (Side Windows).
- 14 P1326 Glazing Rubber. (per metre) Thin panel.
- 15 P1327 Filler Strip. For above (per metre).
- 16 P1800 Glazing Rubber. (per metre) Timber panel.
- P1801 Filler Strip. For above (per metre).
- 17 P1212 Sliding Window.
- 18 P1212B Push Button. For sliding window.
- 19 KX4323 Window Protection Bars. (pair). For use when sliding windows fitted.
- 20 P1202 Roof (Nosecone) Pop-Up Ventilator HB403.
- KX3083 Roof Vent Kit (mk2) HB506 & HB511. This kit includes 2 roof vent hinges, springs, brackets and roof vent lid.
- 21 CP00365 Roof Ventilator Lid HB506, HB511.
- CP00366 Roof Ventilator Hinge HB506, HB511.
- 22 CP00367 Roof Vent Spring LH HB506, HB511.
- CP00368 Roof Vent Spring RH HB506, HB511.
- 23 CP00549 Roof Vent Spring Bracket. Compatible with the HB506 & HB511 mk2.
- 24 CP00370 Roof Vent Spring Retainer HB506, HB511.

KICKBOARD & PADDING

- 25 CP00310 Kickboard. (lower side panel) HB403, HB506.
- 26 CP00311 Kickboard. (lower side panel) HB511.
- 27 CP00308-14 Padding. (side panel) Cream HB403, HB506.
- 28 CP00309-14 Padding. (side panel) Cream HB511.
- 29 CP00312 Padding End Retainer.





RAMP & REAR DOOR SPARES

All rear door kits are supplied with hinges, release toggles and fittings.

- 1** C31249 Ramp Closure Handle.
- 2** P00165 Bolt Head Cover. (silver-grey for ramp handle).
- 3** WA00052 Front Ramp Hinge Assembly.
- 4** CP00172 Front Body Grab Handle. Nylon moulded pull handle.
CP00173 Top Door Retainer Pin. Used to secure the front and rear doors in the open position.
- 5** CP00415 Buffer – Upper Door Retainer. Used with CP00173.
- 6** WA00157 Upper Door Hinge Assembly. (rear – long offset).
- 7** WA00158 Upper Door Hinge Assembly. (side – short offset). Also used on the inspection door.
- 8** WA00166 Upper Door Retainer Release Assembly.
- 9** P1191 Gas Spring. (Front and rear ramp).
P1193 Gas Spring. This gas spring will eventually supersede P1191 totally over a period of 9 months starting in September 2016. (The two parts are interchangeable). 2100N
- 10** P1192 Gas Spring Cover.
- 11** P1228 Ramp Guide. (Rear ramp – all models).
- 12** CP00348 Ramp Guide. (front ramp – all models).
- 13** C00150 Ramp Latch Staple. (Rear ramp – all models).
- 14** CP00091 Ramp Latch Staple. (front ramp – all models).
CP00446 Barrel Nut. (Rear Ramp Latch Staple).
- 15** P1803 Inspection Door Lock. (outer) assembly.
- 16** WA00460 Inspection Door Latch. (inner) assembly.
CP00399 Inspection Door Lock Keeper.

REAR DOOR KITS HB403

- KS3080L-01B Rear Door. Left hand HB403 Silver.
- KS3080R-01B Rear Door. Right hand HB403 Silver.
- KS3080L-04B Rear Door. Left hand HB403 Red.
- KS3080R-04B Rear Door. Right hand HB403 Red.
- KS3080L-05B Rear Door. Left hand HB403 White.
- KS3080R-05B Rear Door. Right hand HB403 White.
- KS3080L-06D Rear Door. Left hand HB403 Bala blue.
- KS3080R-06D Rear Door. Right hand HB403 Bala blue.
- KS3080L-08A Rear Door. Left hand HB403 Black.
- KS3080R-08A Rear Door. Right hand HB403 Black.
- KS3080L-12B Rear Door. Left hand HB403 Graphite.
- KS3080R-12B Rear Door. Right hand HB403 Graphite.

HB506 (MK2)

- KS3081L-01B Rear Door. Left hand HB506 Silver.
- KS3081R-01B Rear Door. Right hand HB506 Silver.
- KS3081L-04B Rear Door. Left hand HB506 Red.
- KS3081R-04B Rear Door. Right hand HB506 Red.
- KS3081L-05B Rear Door. Left hand HB506 White.
- KS3081R-05B Rear Door. Right hand HB506 White.
- KS3081L-06D Rear Door. Left hand HB506 Bala blue.
- KS3081R-06D Rear Door. Right hand HB506 Bala blue.
- KS3081L-08A Rear Door. Left hand HB506 Black.
- KS3081R-08A Rear Door. Right hand HB506 Black.
- KS3081L-12B Rear Door. Left hand HB506 Graphite.
- KS3081R-12B Rear Door. Right hand HB506 Graphite.

HB511 (MK2)

- KS3082L-01B Rear Door. Left hand HB511 Silver.
- KS3082R-01B Rear Door. Right hand HB511 Silver.
- KS3082L-04B Rear Door. Left hand HB511 Red.
- KS3082R-04B Rear Door. Right hand HB511 Red.
- KS3082L-05B Rear Door. Left hand HB511 White.
- KS3082R-05B Rear Door. Right hand HB511 White.
- KS3082L-06D Rear Door. Left hand HB511 Bala blue.
- KS3082R-06D Rear Door. Right hand HB511 Bala blue.
- KS3082L-08A Rear Door. Left hand HB511 Black.
- KS3082R-08A Rear Door. Right hand HB511 Black.
- KS3082L-12B Rear Door. Left hand HB511 Graphite.
- KS3082R-12B Rear Door. Right hand HB511 Graphite.

1 FRONT RAMP DOORS

Compatible with the mk1 & mk2 models, these door kits include hinges and fastenings but exclude windows.

HB403 & HB506

KS2276-01B	Front Ramp Door. Left Hand Silver.
KS2274-01B	Front Ramp Door. Right Hand Silver.
KS2276-04B	Front Ramp Door. Left Hand Red.
KS2274-04B	Front Ramp Door. Right Hand Red.
KS2276-05B	Front Ramp Door. Left Hand White.
KS2274-05B	Front Ramp Door. Right Hand White.
KS2276-06D	Front Ramp Door. Left Hand Bala Blue.
KS2274-06D	Front Ramp Door. Right Hand Bala Blue.
KS2276-08A	Front Ramp Door. Left Hand Black.
KS2274-08A	Front Ramp Door. Right Hand Black.
KS2276-12B	Front Ramp Door. Left Hand Graphite.
KS2274-12B	Front Ramp Door. Right Hand Graphite.

HB511

KS2272-01B	Front Ramp Door. Left Hand Silver.
KS2270-01B	Front Ramp Door. Right Hand Silver.
KS2272-04B	Front Ramp Door. Left Hand Red.
KS2270-04B	Front Ramp Door. Right Hand Red.
KS2272-05B	Front Ramp Door. Left Hand White.
KS2270-05B	Front Ramp Door. Right Hand White.
KS2272-06D	Front Ramp Door. Left Hand Bala Blue.
KS2270-06D	Front Ramp Door. Right Hand Bala Blue.
KS2272-08A	Front Ramp Door. Left Hand Black.
KS2270-08A	Front Ramp Door. Right Hand Black.
KS2272-12B	Front Ramp Door. Left Hand Graphite.
KS2270-12B	Front Ramp Door. Right Hand Graphite.

2 INSPECTION DOOR KITS

These kits include hinges and lock mechanism.

KS3071L-01B	Inspection Door Kit. Left hand Silver.
KS3071R-01B	Inspection Door Kit. Right hand Silver.
KS3071L-04B	Inspection Door Kit. Left hand Red.
KS3071R-04B	Inspection Door Kit. Right hand Red.
KS3071L-05B	Inspection Door Kit. Left hand White.
KS3071R-05B	Inspection Door Kit. Right hand White.
KS3071L-06D	Inspection Door Kit. Left hand Bala Blue.
KS3071R-06D	Inspection Door Kit. Right hand Bala Blue.
KS3071L-08A	Inspection Door Kit. Left hand Black.
KS3071R-08A	Inspection Door Kit. Right hand Black.
KS3071L-12B	Inspection Door Kit. Left hand Graphite.
KS3071R-12B	Inspection Door Kit. Right hand Graphite.

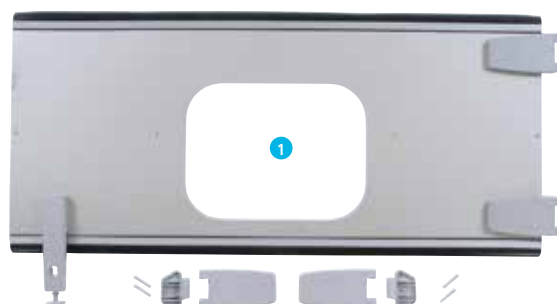











**MK2 trailers
manufactured
from May 2011
onwards**







**Front Panel Kits,
Roof Kits, Top
Side Panels, Pillars
and Flooring**

FRONT PANEL KITS













	KS2264-01B	Front Nose panel MK1 to mk2 Conversion Kit. HB506/HB511 Silver.
	KS2264-04B	Front Nose panel MK1 to MK2 Conversion Kit. HB506/HB511 Red.
	KS2264-08A	Front Nose panel MK1 to MK2 Conversion Kit. HB506/HB511 Black.
	KS2264-12B	Front Nose panel MK1 to MK2 Conversion Kit. HB506/HB511 Graphite.
	KS2266-01B	Front Nose Panel Kit MK2. HB506/ HB511. Silver.
	KS2266-04B	Front Nose Panel Kit MK2. HB506/ HB511. Red.
	KS2266-05B	Front Nose Panel Kit MK2. HB506/ HB511. White.
	KS2266-06D	Front Nose Panel Kit MK2. HB506/ HB511. Bala Blue.
	KS2266-08A	Front Nose Panel Kit MK2. HB506/ HB511. Black.
	KS2266-12B	Front Nose Panel Kit MK2. HB506/ HB511. Graphite.
	CP00589	Left hand Bottom Corner Moulding. Fitted at the bottom of the front panel, included within the MK1 to MK2 conversion kits.
	CP00590	Right hand Bottom Corner Moulding. Fitted at the bottom of the front panel, included within the MK1 to MK2 conversion kits.

ROOF KITS

	KS3076	HB506 MK1 Roof Conversion Kit. This kit is required when replacing a roof on a mk1 trailer. Please note that when using this conversion replacement MK2 rear doors are also required (Supplied separately)
	KS3077	HB511 MK1 Roof Conversion Kit. This kit is required when replacing a roof on a mk1 trailer. Please note that when using this conversion replacement MK2 rear doors are also required (Supplied separately)
	KS3078	HB506 MK2 Replacement Roof Kit.
	KS3079	HB511 MK2 Replacement Roof Kit.

TOP SIDE PANELS

These panels are fitted between the roof and side panel

	CP00552-01B	Top Side Panel. Silver HB506 MK2 / HB403.
	CP00552-04B	Top Side Panel. Red HB506 MK2 / HB403.
	CP00552-05B	Top Side Panel. White HB506 MK2 / HB403.
	CP00552-06D	Top Side Panel. Bala Blue HB506 MK2 / HB403.
	CP00552-08A	Top Side Panel. Black HB506 MK2 / HB403.
	CP00552-12B	Top Side Panel. Graphite Grey HB506 MK2 / HB403.
	CP00553-01B	Top Side Panel. Silver HB511 MK2.
	CP00553-04B	Top Side Panel. Red HB511 MK2.
	CP00553-05B	Top Side Panel. White HB511 MK2.
	CP00553-06D	Top Side Panel. Bala Blue HB511 MK2.
	CP00553-08A	Top Side Panel. Black HB511 MK2.
	CP00553-12B	Top Side Panel. Graphite Grey HB511 MK2.

PILLARS

CP01001	Front Pillar. Left Hand. For a trailer with a left hand front ramp.
CP01002	Front Pillar. Right Hand. For a trailer with a right hand front ramp.
CP01003	Front Pillar. Left Hand. For a trailer with a right hand front ramp or a Basic model.
CP01004	Front Pillar. Right Hand. For a trailer with a left hand front ramp or a Basic model.
CP01029	Rear Corner Pillar. Left Hand. Compatible with the standard rear ramp and van door models.
CP01030	Rear Corner Pillar. Right Hand. Compatible with the standard rear ramp and van door models.
CP01031	Middle Pillar. Left hand. For a trailer with a left hand front ramp.
CP01032	Middle Pillar. Right hand. For a trailer with a right hand front ramp.
CP01033	Middle Pillar. Left hand. For a trailer with a right hand front ramp or a Basic model.

EXTRUSIONS

ET00074-01025	Horizontal Joint Cover. HB506. Fitted above the inspection door.
ET00074-01182	Horizontal Joint Cover. HB511. Fitted above the inspection door.

FLOOR & RAMP MATTING



CP00116	Floor Matting. Ribbed rubber mat pre-cut to fit The HB511 mk2.
CP00115	Floor Matting. Ribbed rubber mat pre-cut to fit The HB506 mk2.
CP00223	Floor Matting. Ribbed rubber matting pre-cut to fit HB403 suitable for either right or left hand side front ramp.
CP0000277	Rear Ramp Matting. High grip rubber matting pre-cut to fit HB511
CP00275	Rear Ramp Matting. High grip rubber matting pre-cut to fit HB506
CP00273	Rear Ramp Matting. High grip rubber matting pre-cut to fit HB403
CP00276	Rear Ramp Matting. High grip rubber matting pre-cut to fit HB511
CP00274	Rear Ramp Matting. High grip rubber matting pre-cut to fit HB506 & HB403

ALUMINIUM FLOORS





Suitable for either right or left hand side front ramps

WA00114	Aluminium Floor Kit. Pre formed aluminium floor and finisher strips to fit the HB511 mk2.
WA00113	Aluminium Floor Kit. Pre formed aluminium floor and finisher strips to fit the HB506 mk2.
WA00220	Aluminium Floor Kit. Pre formed aluminium floor and finisher strips to fit HB404
KS27230	Floor Matting Retaining Hardware Set. Set of 4 Staples with fixing hardware.

TACK STORAGE

-  **1 KX01251 Removable Tack Pack silver.** Removable storage unit for the HB505, HB510, HB506 & HB511 series, includes galvanized Saddle rack, removable feed bowl and lockable front fasteners.
- 2 P0448 Tack Pack Wheel.** Replacement wheel for Tack Pack units.
- 3 P0449 Axle.** Replacement axle to fit the Tack Pack unit.
-  **4 KX012414 Door Mounted Tack Pack Cream.** Attached to the grooms door, suitable for the HB403, HB506 & HB511. This neat storage solution is capable of storing two saddles and various tack. Suitable for General Purpose saddles up to 17" (43cm). We advise that you check saddles fit prior to purchase.
- 5 KX01231 Fastening Kit.** (Door mounted Tack Pack) Silver.

ACCESSORIES

- 6 KX0830 Mesh Internal Storage Pouch.** Ideal for storing trailer manuals and other small items such as hair brushes etc. Available for the HB506 & HB511.
- 7 B0230 Digital Trailer Camera.** Includes wireless digital wide angled camera with night vision, 5" LCD monitor, monitor holder and power cables. Powered as standard from the trailer lighting system with the option of purchasing a battery pack for powering with more flexibility. See pages 27 & 28 for full details.
- 8 B0163 Grooms Door Vanity Mirror.** A choice of where it can be positioned within the trailer.
- 9 KX0233 Prop Stand Kit.** Consider prop stands if your horse requires a particularly steady surface to load. Additional support will reassure nervous horses.
-  **10 KX0840 Hay Net Rail Kit.** Compatible with the HB403 & HB506 manufactured after Sept 2012 with a slot above the front ramp as standard. This kit allows for the hay net rail to be fitted to both sides of the trailer and includes a rail for fitting above the inspection door and 2 sets of eyebolts and sliding nuts.
-  **KX0841 Hay Net Rail Kit.** Compatible with the HB511 manufactured after Sept 2012 with a slot above the front ramp as standard. This kit allows for the hay net rail to be fitted to both sides of the trailer and includes a rail for fitting above the inspection door and 2 sets of eyebolts and sliding nuts.
-  **KX0842 Haynet Rail Kit.** Compatible with the HB403 & HB506 manufactured between 2008 and Sept 2012. This kit includes 2 rails and 2 sets of eyebolts and sliding nuts.
-  **KX0843 Haynet Rail Kit.** Compatible with the HB511 manufactured between 2008 and Sept 2012. This kit includes 2 rails and 2 sets of eyebolts and sliding nuts.
- KX0844 Haynet Eyelet Assembly.** This kit is compatible with trailers built after 2012 with a slot above the front ramp as standard and when a hay net is only required on this side. This kit includes 1 eyebolt and 1 sliding nut.
- CP011112 Sliding Rail Nut M8**
- CP01111 M8 x 18 Eyebolt.**

**MK2 trailers manufactured
from May 2011 onwards**

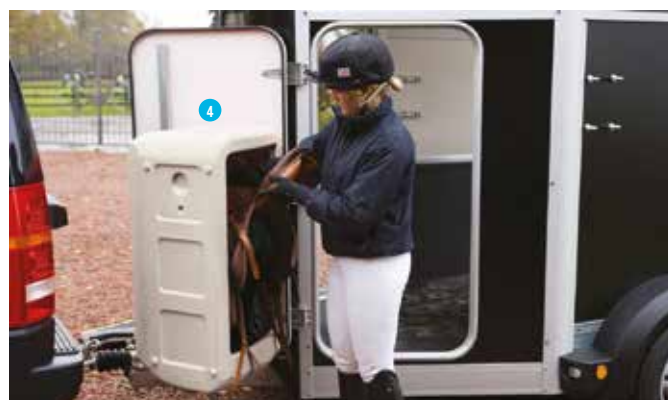
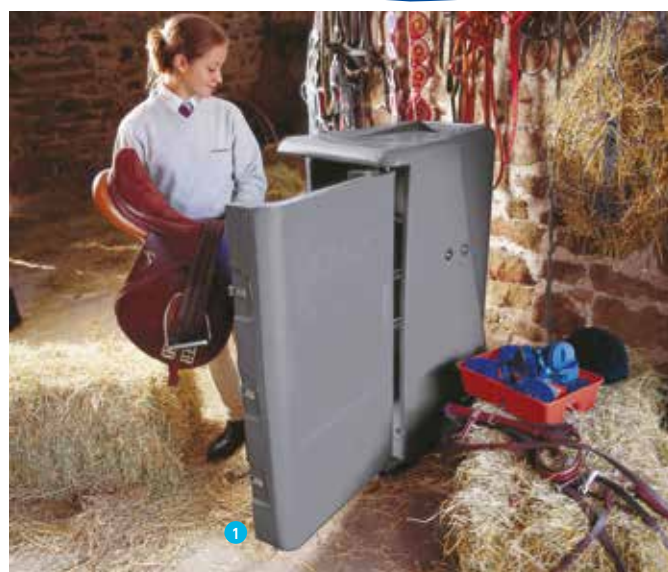

TRAILER COVERS

- 1 B01686L** Trailer Cover HB403 / HB401. For models with a left hand side inspection door. Blue
 - B01686R** Trailer Cover HB403 / HB401. For models with a right hand side inspection door. Blue
 - B01696L** Trailer Cover HB506 / HB505. For models with a left hand side inspection door. Blue
 - B01696R** Trailer Cover HB506 / HB505. For models with a right hand side inspection door. Blue
 - B01706L** Trailer Cover HB510 / HB511. For models with a left hand side inspection door. Blue
 - B01706R** Trailer Cover HB510 / HB511. For models with a right hand side inspection door. Blue
- Trailer Aid.** Used when replacing a flat or punctured tyre. Saves time and energy no need to use a jack. Available in black and yellow.
- 2 B0054** Black.
 - B0055** Yellow.



HB510

These silver partitions can also be used to replace the coloured partitions in trailers manufactured since January 1999, both types are fully interchangeable with the head partitions.



- 1 P1084 **Head Partition.** For HB510.
- 2 C00130 **Pin.** Retainer pin for head partitions (From 1999).
P1150 **Ring.** 38mm Split ring.
- 3 KS30471 **Partition Leaf.** (Front) Silver padding includes rubber skirt.
- 4 KS30451 **Partition Leaf.** (Rear) Silver padding includes rubber skirt.
- 5 C82544 **Partition Skirt.** HB510 for front or rear use.
- 6 P1021 **Retainer Hook.** Used to hold the centre partition open whilst loading.
- 7 P1022 **Mini Tye.** Soft rubber used on horsebox head partitions or for general holding and tie back. 135mm centres.
- 8 P1025 **Mini Tye.** Longer version. 225mm centres.
- 9 AS7590 **Centre Pillar.** HB510 - the type used from January 1999.
- 10 AS7509 **Fixing Bracket.** HB510 - Fixes the centre partition pole to the trailer roof.
- 11 C11153 **Fixing Bracket.** Used where centre partition pole enters the floor.
- 12 C00077 **Clevis Pin.** Used to secure the centre partition pole to the upper bracket (HB505/510 or TA5 models with horse kit).
- 13 F1913Z **R Clip.** Holds the centre partition clevis securely in place.
- 14 P1110/50SS **Linch Pin.** 1/4 inch diameter lynch pin and snap ring with retainer chain fitted (50mm pin). Stainless steel.
- 15 KS27218 **Breast/Breeching Bar.** For HB510 (Black).
- 16 KX01168 **Breast/Breeching Bar Full Length.** For horses that prefer to travel in a wider stall. Centre partitions are removed and full width breast and breeching bars are fitted.
- 17 C31253 **Pin End.** Pin end casting for breast/breeching bars.
- 18 C31252 **Hook End.** Hook end casting for breast/breeching bars.
- 19 C31259 **Pin End (Sliding).** Pin end casting for full width breeching bars.
- 20 C31250 **Receiver Bracket.** Three hole breeching bar receiver bracket.
- 21 F0923ZPK **Socket Screw.** M8 x 40 Cap head. Used to secure the breast bar bracket to the centre partition panel. **Pack 10**
- 22 F1003ZPK **Nut.** M8 Plain hex type. **Pack 20**

- 23 F0932ZPK-01B **Socket Screw Silver.** M8 x 35 button head screw retains the breast / breeching bar receiver bracket from the outside of the trailer. **Pack 16**
- 24 F1103ZPK-01B **Retainer Washer Silver.** This washer sits underneath the socket screw on the outside of the trailer. **Pack 16**
- 25 P1278PK **Neoprene Washer.** 40mm washer used under the breast/breeching bar retainer washers. **Pack 16**
- 26 P1260 **Hex key.** For the Horsebox breast/breeching bar release system on HB401, 505 & 510.

HB505

These silver partitions can also be used to replace the coloured partitions in trailers manufactured since January 1999, both types are fully interchangeable with the head partitions.



- 1 P1085 **Head Partition.** For HB505.
- 2 C00130 **Pin.** Retainer pin for head partitions (From 1999).
P1150 **Ring.** 38mm Split ring.
- 3 KS30481 **Partition Leaf.** (Front) Silver padding includes rubber skirt.
- 4 KS30461 **Partition Leaf.** (Rear) Silver padding includes rubber skirt.
- 5 C82543 **Partition Skirt.** HB505 for front or rear use.
- 6 P1021 **Retainer Hook.** Used to hold the centre partition open whilst loading.
- 7 P1022 **Mini Tye.** Soft rubber version used on horsebox head partitions or for general holding and tie back applications. (135mm centres)
- 8 P1025 **Mini Tye.** Longer version with 225mm centres.
- 9 AS7585 **Centre Pillar.** HB505 - the type used since January 1999.
- 10 AS7459 **Fixing Bracket.** HB505 - Fixes the centre partition pole to the trailer roof.
- 11 C11153 **Fixing Bracket.** Used where centre partition pole enters the floor.
- 12 C00077 **Clevis Pin.** Used to secure the centre partition pole to the upper bracket (HB505/510 or TA5 models with horse kit).
- 13 F1913Z **R Clip.** Holds the centre partition clevis securely in place.
- 14 P1110/50SS **Linch Pin.** 1/4 inch diameter linch pin and snap ring with retainer chain fitted (50mm pin). Stainless steel.
- 15 KS26968 **Breast/Breeching Bar.** HB505 plastic covered (Black).
- 16 KX01158 **Breast/Breeching bar full length.** For horses that prefer to travel in a wider stall. Centre partitions are removed and full width breast and breeching bars are fitted.
- 17 C31253 **Pin End.** Pin end casting for breast/breeching bars.
- 18 C31252 **Hook End.** Hook end casting for breast/breeching bars.
- 19 C31259 **Pin End (Sliding).** Pin end casting for full width bars.
- 20 C31250 **Receiver Bracket.** Three hole cast receiver bracket.
- 21 F0923ZPK **Socket Screw.** M8 x 40 Cap head. Used to secure the breast bar bracket to the centre partition panel. **Pack 10**
- 22 F1003ZPK **Nut.** M8 Plain hex type. **Pack 20**

- 23 F0932ZPK-01B **Socket Screw Silver.** M8 x 35 button head screw retains the breast / breeching bar receiver bracket from the outside of the trailer. **Pack 16**
- 24 F1103ZPK-01B **Retainer Washer Silver.** This washer sits underneath the socket screw on the outside of the trailer. **Pack 16**
- 25 P1278PK **Neoprene Washer.** 40mm washer used under the breast/breeching bar retainer washers. **Pack 16**
- 26 P1260 **Hex Key.** For the Horsebox breast/breeching bar release system on HB401, 505 & 510.
- 27 KS26858 **Breaching Bar.** HB401.

HB401, HB505 & HB510

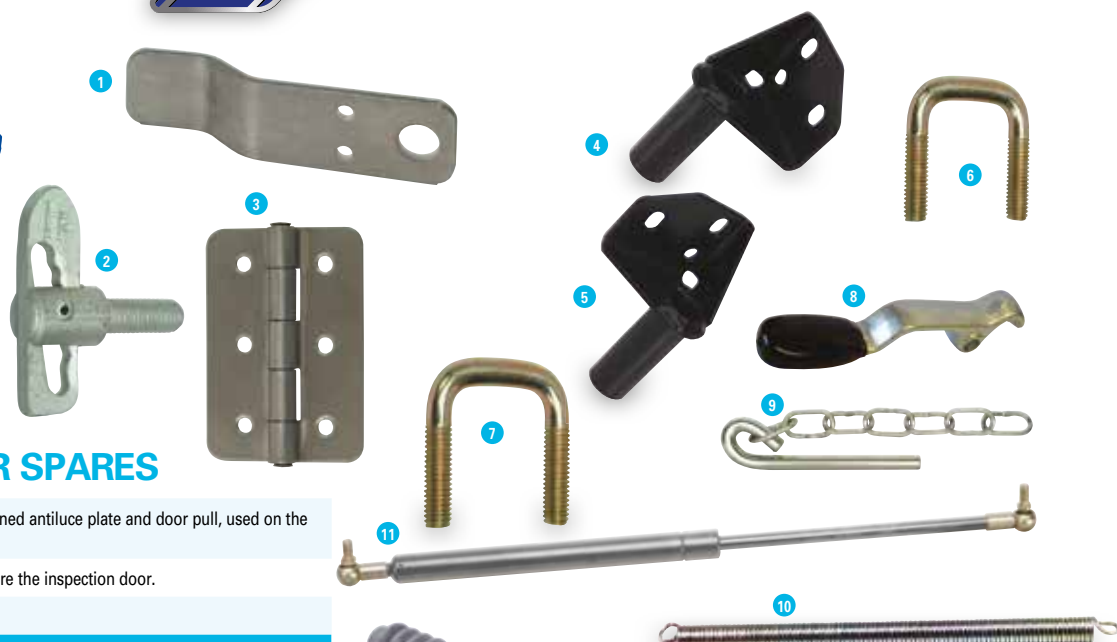

INSPECTION DOOR SPARES

- 1 C10617SS Door Pull. Stainless steel combined antiluce plate and door pull, used on the inspection doors.
- 2 P1004 Antiluce Fastener. Used to secure the inspection door.
- 3 P1072SS Inspection Door Hinge.

FRONT & REAR RAMP SPARES

- 4 AS1683 Hinge Pin. RH front ramp hinge pin.
- 5 AS1684 Hinge Pin. LH front ramp hinge pin.
- 6 C00150 Ramp Handle Staple. Front Ramp
- 7 C00151 Ramp Handle Staple. Rear Ramp.
- C15307 Number Plate Backing Panel.
- 8 C31249 Ramp Closure Handle. Fitted to the front and rear ramps.
- 9 P11190 Pin & Chain. Used to secure the front and rear ramp closure handles.
- 10 P1163 Rear Ramp Spring.
- 11 P1191 Gas Spring. Fitted to assist with the lifting of the front ramp.
- 12 P1192 Protective Bellows.



UPPER DOOR SPARES

- 13 AS0630SS Linch Pin Receiver. Fitted to the side of the trailer to hold the front and rear doors in the open position.
- 14 C11154 Front Door Hinge. Cranked stainless steel hinge fitted to the door above the front ramp.
- 15 C11155 Rear Door Hinge. Stainless steel hinge fitted to the doors above the rear ramp.
- 16 P1110/50SS Linch Pin & Chain. Used to hold the front and rear doors in the open and closed positions.

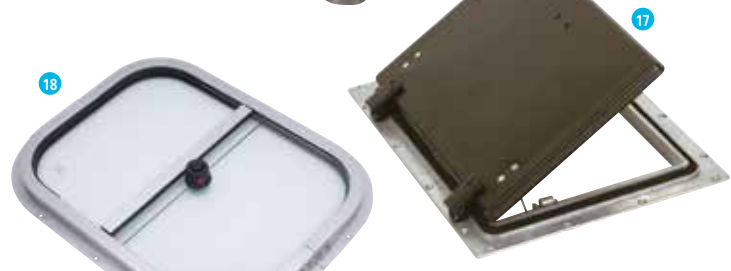

VENTS & GLAZING

- 17 P1202 Roof Vent. Fitted to the front GRP roof of the HB401, HB403, HB505 & HB510
- 18 P1212 Sliding Window. Fitted to the Classic series.
- 19 P1212/B Sliding Window Push Button.
- 20 P1213 Safety Glass. Fitted to the front panel and the front ramp door on the HB510.



SEALS

- 21 P1304 Rubber Seal. Used as a seal for the front and rear ramps, inspection doors and rear doors. Sold per metre.
- 22 P1311 Beading. Vertical seal for the rear doors and for the rear light brackets. Sold per metre.
- 23 P1326 Glazing Rubber. Used to seal P1213. Sold per metre.
- 24 P1327 Glazing Filler Strip. Used to seal P1213. Sold per metre.



HB505 double horsebox

KICKBOARD PANELS

-  **1 C79015** Kickboard. LH Kickboard for HB510 (1999 on). Can be cut down to fit the HB505
- C79016** Kickboard. RH Kickboard for HB510 (1999 on). Can be cut down to fit the HB505

FLOOR & REAR RAMP MATTING

-  **2 C80814** Floor Matting. Ribbed rubber matting pre cut to fit HB505 (Post 1992).
- C80816** Floor Matting. Ribbed rubber matting pre cut to fit HB510.
- 3 C890454** Ramp Matting. High grip rubber matting pre cut to fit HB505 Rear ramp 1520mm x 1508mm x 6mm.
- C890455** Ramp Matting. High grip rubber matting pre cut to fit HB510 Rear ramp. 1520mm x 1615mm x 6mm
- 4 KS27230** Floor Mat Fixing - set of 4. Staples with fixing hardware.







- 5 C49769** Corner Moulding. 1513mm. Used to secure the rear ramp matting on the HB505. Horizontal.
- C49779** Corner Moulding. 1620mm. Used to secure the rear ramp matting on the HB510. Horizontal.
- C497635** Square Corner Moulding. 1524mm. Used to secure front and rear ramp matting on the HB401, HB505 & HB510. Vertical.

FRONT RAMP MATTING

- 6 C890451** Ramp Matting. High grip rubber matting pre cut to fit HB401/505 Front ramp 1520mm x 983mm x 6mm.
- C890453** Ramp Matting. High grip rubber matting pre cut to fit HB510 Front ramp 1520mm x 1140mm x 6mm.



ALUMINIUM FLOOR KITS

-  **7 KS0700** Aluminium Floor Kit. Pre formed aluminium floor and finisher strips, to fit HB505 (Pre 1992).
-  **KS0705** Aluminium Floor Kit. Pre formed aluminium floor and finisher strips, to fit HB401.
-  **KS0711** Aluminium Floor Kit. Pre formed aluminium floor and finisher strips, to fit HB505 (Post 1992).
-  **KS0720** Aluminium Floor Kit. Pre formed aluminium floor and finisher strips, to fit HB510.



ALUMINIUM ROOF SHEETS

	C49278-SVR	Silver Aluminium Roof Sheet. HB401.
	C49275-SVR	Silver Aluminium Roof Sheet. HB505.
	C49270-SVR	Silver Aluminium Roof Sheet. HB510.

GRP ROOF PANELS

	C72440/SILVER	Silver GRP Roof Panel. HB401.
	C72421/SILVER	Silver GRP Roof Panel. HB505.
	C72430/SILVER	Silver GRP Roof Panel. HB510

ROOF CHANNELS & COVERS

	C19303	Roof Channel. HB505.
	C19345	Roof Channel. HB510.
	P1322	Roof Channel Cover. White, snap in plastic 6334mm.

FRONT & REAR RAMP PILLARS

	C10831	Front Ramp Pillar. HB505/401 Right hand – nearest front of trailer.
	C10832	Front Ramp Pillar. HB505/401 left hand – nearest rear of trailer.
	C10841	Front Ramp Pillar. HB510 Right hand – nearest front of trailer.
	C10842	Front Ramp Pillar. HB510 left hand – nearest rear of trailer.
	C10862	Rear Ramp Pillar. HB505/ 401 right hand.
	C10863	Rear Ramp Pillar. HB5058 / 401 left hand
	C10860	Rear Ramp Pillar. HB510 right hand.
	C10861	Rear Ramp Pillar. HB510 left hand.

REAR LIGHT BRACKETS

	C11280	Light Bracket. HB401, 505 & 510 right hand.
	C11281	Light Bracket. HB401, 505 & 510 left hand.

REAR FOOT PLATES







	C11400	Footplate. HB401 & 505 right hand.
	C11401	Footplate. HB401 & 505 left hand.
	C11403	Footplate. HB510 right hand.
	C11404	Footplate. HB510 left hand.
	C11407	Footplate. HB401 & 505 Classic right hand.
	C11408	Footplate. HB401 & 505 Classic left hand.
	C11412	Footplate. HB510 Classic right hand.
	C11413	Footplate. HB510 Classic left hand.



2





















PARTITION KITS

-  **KX0117 Full Width Partition Kit.** HB510XL Simply hang on the mounting rail & clip in place. Silver finish to the partition with a clear plastic skirt.
-  **1 KX0118 Full Width Partition Kit.** HB610 Simply hang on the mounting rail & clip in place. Silver finish to the partition with a clear plastic skirt.
-  **C11050 Partition Mounting Rail.** 4 fitted per trailer.
-  **P10851 Head Partition Kit.** HB510XL & HB610 Bolts on to any existing full width partition.
-  **KX01301 Centre Partition Kit.** Traditional style "side by side" partition system for carrying two large horses facing forwards in the HB510XL. Supplied with silver padded centre partition panels, Black breast and breeching bars, centre pole and all fittings.
-  **KX01291 Centre Partition Kit.** Traditional style "side by side" partition system for carrying two large horses facing forwards in the HB610. Supplied with silver padded centre partition panels, Black breast and breeching bars, centre pole and all fittings.

OPTIONAL ACCESSORIES

- KX4321 Window guard Kit.** Black powder coated bars (6) & fasteners for HB510XL.
- KX4320 Window Guard Kit.** Black powder coated bars (5) & fasteners for HB610.
- 2 KX01168 Breeching Bar.** HB510XL fits across rear ramp aperture (Black).
- KS26858 Breast Bar.** HB610 fits across front ramp aperture (Black).
- KS27258 Breeching Bar.** HB610 fits across rear ramp aperture (Black).

BODY & FLOORING SPARES

-  **C11280 Rear Light Bracket.** HB510XL, right hand.
- C11281 Rear Light Bracket.** HB510XL, left hand.
- AS2196 Rear Corner Pillar.** HB510XL, right hand.
- AS2197 Rear Corner Pillar.** HB510XL, left hand.
- C12432 Rear Light Mounting Bracket.** HB610, non handed.
- C12430 Rear Corner Pillar.** HB610, right hand.
- C12431 Rear Corner Pillar.** HB610, left hand.
-  **C14697 Outer Roof Sheet.** Right hand HB610.
-  **C14695 Outer Roof Sheet.** Left hand HB610 (Left & Right hand HB510XL).
-  **C14696 Centre Roof Sheet.** HB610.
-  **C14689 Centre Roof Sheet.** HB510XL.
-  **P1202 Roof Vent.**
- P1212 Sliding Window.**
- P1212/B Push Button.** For the sliding window.
-  **C19353 Roof Channel.** HB610.
-  **C19345 Roof Channel.** HB510XL.
-  **P1322 Roof Channel Cover.**
-  **AS0770 Aluminium Floor.** Multi-planked Aluminium floor assembly to fit HB510XL.
-  **AS0725 Aluminium Floor.** Multi-planked Aluminium floor assembly to fit HB610.
-  **C80848 Rubber Matting.** One piece rubber matting to fit HB510XL (cut to fit HB510XL-10).
-  **C80849L Rubber Matting.** Left side Half matting to fit HB610.
-  **C80849R Rubber Matting.** Left side Half matting to fit HB610.
-  **KS3004 Rear Doors.** Pair of doors fitted above rear ramp on HB510XL 2.3M Headroom.
-  **KS3009 Rear Doors.** Pair of doors fitted above rear ramp on HB610 2.3M Headroom.
-  **C72053 GRP Nosecone.** Basic (non-storage) version for HB510XL models.
-  **C72049 GRP Nosecone.** Storage nose version for HB510XL models.
-  **C72056 GRP Nosecone.** Storage nose version for HB610 models.



1



3



4



5

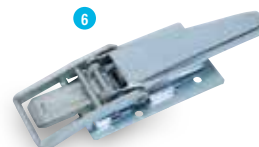

6





8



7

BODY & FLOORING SPARES (CONTINUED)

-  **KS0920 Storage Nose Conversion Kit.** Full kit of parts to convert basic HB510XL models to the storage nose system. Includes GRP nosecone, upper front panel, sliding doors, track and all fasteners required.
- C79249-1 Interior Plastic Panel.** Silver 4300mm x 735mm.
-  **C79015 Kickboard.** Right Hand.
- C79016 Kickboard.** Left Hand.
- 3 AS7963 Breast Bar Mounting.** HB610.
- 4 C11045 Breast Bar Mounting Bracket.** HB610.

RAMP SPARES

- 5 AS1683 Front Ramp Hinge.** HB610, right hand.
- AS1684 Front Ramp Hinge.** HB610, left hand.
- 6 P1079 Over Centre Ramp Fastener.** Secures the front ramp HB610.
- 7 AS7793 Ramp Fastener Receiver.** Secures P1079 on the front ramp HB610.
- C31249 Ramp Fastener Handle.** Secures the rear ramp
- C00150 Ramp Fastener Staple.** Secures the C31249 on the rear ramp .
- C20937 Rear Ramp Hinge.**
- P1246 Ramp Hinge Bush.**
- P1161 Ramp Spring.** Front & rear ramp HB610.
- P1163 Ramp Spring.** Rear ramp HB510XL.
- C04217 Ramp Spring Bracket.** Right hand.
- C04219 Ramp Spring Bracket.** Left hand.

INSPECTION DOOR SPARES

- AS4275 Latch Keep Assembly.**
- C00273 Door Latch Bridge.**
- C70322 Internal Latch Cover.**
- 8 P1066 Lockable Paddle Latch.**
- P10725 Inspection Door Hinge.**



GROOMS DOOR FITTINGS

- 1 P1803 Outer Door Latch & Keys. Used on the internal and external entrance doors, storage locker and tack locker.
- 2 P1804 Inner Latch. Used on the internal and external entrance doors, storage locker and tack locker.
- 3 CP02109 Internal Latch Hole Cover.
- 4 P4175 Door Keep. Used with P1803 & P1804 to keep the doors closed.
- 5 P1012F Door Holder – Female.
- 6 P1012M Door Holder – Male.
- 7 P4126 Door Retainer. Holds the entrance door in the open position.
- 8 P4159 Entrance Door Fly Screen.

SIDE STEP & FITTINGS

- 9 KS7711 Side Step Kit. Distributor Supply Only.
- 10 P4032 Compartment Latch. Releases the side step.
- 11 P1385 Anti Slip Pads. Fitted to the side step to give a non slip surface.

LIVING AREA

- 12 KS7716 Cupboard Lock kit. One complete assembly. Fitted to the head lockers, kitchen units and internal storage cupboards.
- P4000 Kitchen Sink
- 13 P4019 Side / Sink Window.
- 14 P4020 Blind & Fly Screen. For the side / sink window.
- P4056 Front Window.
- P4057 Blind & Fly Screen. For the front window.
- CP01807 Bunk Bed Mattress.
- 15 P2100 Bunk Bed Ladder.
- 16 P4090 Bunk Bed Safety Net.
- 17 P4095 Bunk Bed Gas Strut.
- 18 P4142 Roof Light. Clear dome, complete with fly screen and blind.
- 19 P4050 12v Water Pump.
- 20 P4051 Water Pump Strainer.

REAR / HORSE AREA

- CP01626 Rubber Floor Mat. Left hand. For the Eventa L
- CP01627 Rubber Floor Mat. Right hand. For the Eventa L
- CP00836 Rubber Floor Mat. One Piece mat for the Eventa M
- 21 P4160 Rear Body Roof Light. Opaque dome.
- 22 CP01600 Sliding Vertical Window.
- 23 WA01799 Sliding Vertical Window Guard.
- 24 P1212 Sliding Horizontal Window.
- 25 P1212/B Push Button. Replacement button for P1212.
- 26 P4283 Gas Strut. Fitted to the tack locker.
- 27 P4095 Gas Strut. Fitted to the external compartment doors.



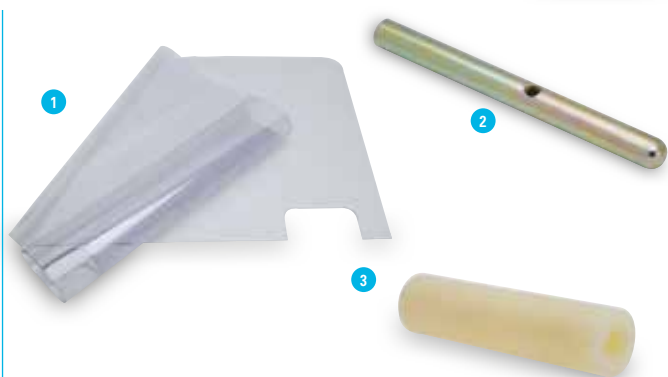

CENTRE PARTITION

- 1 CP02224 Eventa Partition PVC Skirt.
- 2 C00049 Sliding Bolt.
- 3 C70102 Guide Bush. For the C00049 sliding bolt.
- 4 C70103 Spring Bolt Housing.
- 5 P1022 Mini Tye.
- 6 P1041 S Hook.
- 7 P1173 Compression Spring.
- 8 P12361 M8 Pin & Knob Assembly.
- 9 CP02260 Partition Pivot Pin.
- 10 CP01784 Partition Pivot Hinge Bush.

REAR RAMP



- CP01663 Rear Ramp Mat – Top.
- CP01664 Rear Ramp Mat – Bottom.
- 11 WA00669 Rear Ramp Hinge.
- 12 CP01652 Ramp Hinge Pivot Washer.
- 13 P1246 Hinge Pivot Bush.
- 14 C00215 Ramp Spring J Bolt.
- 15 P1184 Ramp Spring. Distributor only supply owing to the difficulty in identification
- 16 CP00684 Ramp Catch Hinge Bracket.
- 17 CP01909 Ramp Catch Release Bolt.
- 18 P1167 Ramp Spring. Distributor only supply owing to the difficulty in identification
- 19 P1835 Rubber Ramp Foot.

BODY COMPONENTS



- 20 CP01635 Front Bumper Moulding. Distributor supply only.
- 21 CP01636 Rear Bumper Moulding. Distributor supply only.

ACCESSORIES

- 22 KX7522 Rug Rack. Can be fitted internally to the horse area. Distributor supply only.
- 23 KX7532 Prop Stand Kit. Additional support for loading when uncoupled or for reassuring nervous horses. Distributor supply only.
- 24 KX7533 External Tie Ring Kit. Distributor supply only.
- 25 P4084 Spare Wheel Cover.
- 26 P4145 Feed Bucket.
- B0170M Trailer Cover. Eventa M.
- B0170L Trailer Cover. Eventa L.





RAMP SPARES

C497113	Ramp Plank. TA5G Easyload™ ramp 1365mm.
C497112	Ramp Plank. TA5G Cattle Ramp 1444mm.
C497132	Ramp Plank. TA510G Cattle ramp 1674mm.
C497135	Ramp Plank. TA510G Easyload™ 1595mm.
C497133	Ramp Plank. DP120G Cattle ramp 1690mm.
C49706	Ramp Plank. DP120G Easy load™ 1610mm.
1 C14324	Ramp Closure Handle. Right hand side.
C14325	Ramp Closure Handle. Left hand side.
2 C11968	Receiver. For ramp closure handles.
3 C01690	Ramp Closure Lock Pin.
P1288	Spring. Used with C01690 lock pin.
C04217	Ramp Spring Attachment Bracket. Right hand.
C04219	Ramp Spring Attachment Bracket. Left hand.
4 AS1744	Ramp Pivot. TA5G/TA510G Right hand.
AS1745	Ramp Pivot. TA5G/TA510G Left hand.
5 AS4330	Ramp Hinge Block. DP120G Right hand.
AS4331	Ramp Hinge Block. DP120G Left hand.
6 C20937	Ramp Hinge Tube. Used on the current DP120G models.
7 P1161	Ramp Spring. Used on all current livestock Trailers.
8 P1246	Hinge Pivot Bush.
9 P12361	M8 Pin and Knob Moulded.

REAR CORNER PILLARS

C14370	Right Hand Rear Corner Pillar TA5G/TA510G 6'.
C14371	Left Hand Rear Corner Pillar TA5G/TA510G 6'.
C14372	Right Hand Rear Corner Pillar TA5G/TA510G 7'.
C14373	Left Hand Rear Corner Pillar TA5G/TA510G 7'.
C14328	Right Hand Rear Corner Pillar DP120G.
C14329	Left Hand Rear Corner Pillar DP120G.



ROOF SHEETS



C14701	Roof Sheet. P8G - 2 per trailer.
C14705	Roof Sheet. TA5G 8' - 2 per trailer.
C14706	Roof Sheet. TA5G 10' - 2 per trailer.
C14707	Roof Sheet. TA5G 12' - 2 per trailer.
C14710	Roof Sheet. TA510G 10' - 2 per trailer.
C14711	Roof Sheet. TA510G 12' - 2 per trailer.
C14712	Roof Sheet. TA510G 14' - 2 per trailer.
C14715	Roof Sheet. DP120G 10' - 2 per trailer.
C14716	Roof Sheet. DP120G 12' - 2 per trailer.
C14717	Roof Sheet. DP120G 14' - 2 per trailer.
C14773	Centre Roof Sheet. 7' Headroom 10' long - 1 per trailer.
C14760	Centre Roof Sheet. 7' Headroom 12' long - 1 per trailer.
C14720	Centre Roof Sheet. 7' Headroom 14' long - 1 per trailer.

ROOF CHANNELS



C19322	Roof Channel. P8G 4' Headroom & P6G.
C19323	Roof Channel. P8G 5' Headroom.
C19324	Roof Channel. TA5G 4' Headroom.
C19314	Roof Channel. TA5G 6' Headroom.
C19306	Roof Channel. TA5G 7' Headroom.
C19309	Roof Channel. TA510G 6' Headroom.
C19302	Roof Channel. TA510G 7' Headroom.
C19307	Roof Channel. DP120G.

FRONT PANELS



C49125	P6G/P8G Front Panel. 1 sheet required for a 4' headroom trailer, 1.5 sheets required for a 5' headroom trailer
C49114	TA5G 4' Headroom.
C49113	TA510G 4' Headroom.
C49060	Front Upper Panel. TA5G 6' headroom.
C49070	Front Lower Panel. TA5G 6' & 7' headroom.
C49114	Front Upper Panel. TA5G 7' headroom.
C49061	Front Upper Panel. TA510G 6' headroom.
C49113	Front Upper Panel. TA510G 7' headroom.
C49071	Front Lower Panel. TA510G 6' & 7' headroom.
C49062	Front Upper Panel. DP120G.
C49072	Front Lower Panel. DP120G.

SIDE PANELS



C44774	Side Panel. 6' (1879.5mm).
C44776	Side Panel. 8' (2495.5mm).
C44780	Side Panel. 10' (3111.5mm).
C44784	Side Panel. 12' (3727.5mm).
C44788	Side Panel. 14' (4343mm).

INSPECTION DOORS

KS2223	Inspection Door. TA5G 4' headroom.
KS2220	Inspection Door Set. Upper & lower TA5G & TA510G.
KS2221	Inspection Door. Upper TA5G & TA510G.
KS2222	Inspection Door. Lower TA5G & TA510G.
KS2225	Inspection Door Set. Upper & Lower DP120G.

DRAWBARS

AS0659	Drawbar Kit. For the DP120S Sealed floor
AS7237	Drawbar Kit. For the DP120G (pre sealed floor)



VENTS, TIE POINTS & LIFTING HANDLES

1 C48990	Aluminium Vent. Used on all current livestock trailers except for 4' headroom models.
2 C89200	Rubber Hinge. Used as pivot for current vents.
3 P1245PK	Deck Cleat. Fitted to the side panels of current livestock trailers to secure vents in the open position. Sold in packs of 10.
C75373	Shoot Bolt. Used on current vents to secure in the closed position.
C75374	Shoot Bolt Spring. Used on current vents to secure in the closed position.
C49119	Aluminium Vent. Used on the current 4' headroom TA5G & TA510G.
4 P1226	Turn Button. Used with the current C49119 vents and on all standard livestock trailers pre 1997.
5 P1230	Vent Hinge. Used with the current C49119 vents and on all standard livestock trailers pre 1997.
6 AS0611	Tie Ring. Solid galvanized steel ring welded to a back plate.
7 C05871	Lifting Handle. Fitted to the DP120 container body to facilitate removal.
C89021	Front Flap Rubber Hinge. Acts as the hinge for the front fold down flap option on the livestock range.

BODY RAILS

Cross Division Receiver Rails

Galvanised steel slotted channel, waist height on left hand body side.



C12018 6' long for 8' body.

C12019 8' long for 10' body.

C12020 10' long for 12' body.

C12021 12' long for 14' body.

Cross Division Base Rails

Galvanised steel slotted rail just above floor on right hand body side.



C14165 8' long for 8' body.

C14166 10' long for 10' body.

C14167 12' long for 12' body.

C14168 14' long for 14' body.

Roof Rail - Left Hand

Galvanised steel section with oval holes, fitted in top left hand corner of body.



C14140 6' long for 8' body.

C14141 8' long for 10' body.

C14142 10' long for 12' body.

C14175 12' long for 14' body.

Roof Rail - Right Hand

Galvanised steel section with round holes, fitted in top right hand corner of body.



C14170 8' long for 8' body.

C14171 10' long for 10' body.

C14172 12' long for 12' body.

C14174 14' long for 14' body.

Roof/Vent Rails

Aluminium extrusion at the base of the roof sheet and forming the top edge of the roof vent.



C48899 6' long for P6 bodies.

C48900 8' long for P8 & TA5G 8'.

C48901 10' long for 10' body.

C48902 12' long for 12' body.

C48903 14' long for 14' body.

Panel Top & Vent Blocker Rails

Aluminium extrusion fitted to the top edge of both upper and lower side panels. Also used to block lower vents when vent flaps are not secured by shoot bolts.



C48920 6' long for 8' body Left Hand.

C48921 8' long for 10' body Left Hand and 8' body Right Hand.

C48922 10' long for 12' body Left Hand 10' body Right Hand.

C48923 12' long for 14' body Left Hand and 12' body Right Hand.

C48924 14' for 14' body Right Hand.

Panel Bottom Rails

Aluminium extrusion fitted to the lower edge of the upper side panels.



C48940 6' long for 8' body Left Hand.

C48941 8' long for 10' body Left Hand and 8' body Right Hand.

C48942 10' long for 12' body Left Hand 10' body Right Hand.

C48943 12' long for 14' body Left Hand and 12' body Right Hand.

C48944 14' for 14' body Right Hand.

Vent Gap Blocker Kits

This kit contains one left hand (short) and one right hand (long) rail plus fittings. These can be used to block upper vent gaps (where vent rails were never fitted) or lower vent gaps where the vents are held closed by shoot bolts but the user prefers the previously fitted blocker rails. Please note that one kit will only block the upper or lower vents. Two kits would be required to block the upper and lower vents.

KX2100/C Vent Gap Reducer kit. For 8' Cattle Trailers.

KX2100/D Vent Gap Reducer kit. For 8' Trailers with sheep decks.

KX2101/C Vent Gap Reducer kit. For 10' Cattle Trailers.

KX2101/D Vent Gap Reducer kit. For 10' Trailers with sheep decks.

KX2102/C Vent Gap Reducer kit. For 12' Cattle Trailers.

KX2102/D Vent Gap Reducer kit. For 12' Trailers with sheep decks.

KX2103/C Vent Gap Reducer kit. For 14' Cattle Trailers.

KX2103/D Vent Gap Reducer kit. For 14' Trailers with sheep decks.

Front Panel Cross-Members

Galvanised steel cross-members fitted inside the front panels as described below:

C19338 P6G/P8G.

C19337 TA5G. Top and middle positions (2 per trailer).

C24203 TA5G. Lower position.

C19335 TA510G. Top and middle positions (2 per trailer).

C24204 TA510G. Lower position.

C19332 DP120G. Top and middle positions (2 per trailer).

C24205 DP120G. Lower position.

Lighting Plates and Number Plate Panels

1 **C11956** Number Plate Panel. Fitted to the TA5G & TA510G.

2 **C11957** Number Plate Backing Panel. Fitted to the TA5G & TA510G.

3 **C12032** Skid and Tank Support. RH fitted to the DP120.

C12033 Skid and Tank Support. LH fitted to the DP120.

4 **C12034** Number Plate & Skid Retainer. Fitted to the DP120.

5 **C12035** Rear Lighting Plate. Fitted to the DP120.

Foot-Plates

Galvanised steel pressings fitted to the TA5G & TA510G immediately behind the wheels.

C14151 8' Right Hand.

C14152 8' Left Hand.

C14153 10' Right Hand.

C14154 10' Left Hand.

C14155 12' Right Hand. Twin axle.

C14156 12' Left Hand. Twin axle.

C14149 12' Right Hand. Tri-axle.

C14150 12' Left Hand. Tri-axle.

C14157 14' Right Hand. Twin axle.

C14158 14' Left Hand. Twin axle.

C14159 14' Right Hand. Tri-axle.

C14160 14' Left Hand. Tri-axle.













Increase the versatility of your 7' headroom livestock trailer by adding this optional horse partition kit. The kit is compatible with the sealed floor trailers.

The style of this centre partition kit may vary from the illustration

TA510 12' long 7' headroom with KX1086 horse partition fitted

-  **KX0180 Centre Partition Kit.** Horsebox style centre partition kit with all fittings, fits a TA5G 7'headroom 10'long with decks.
-  **KX0181 Centre Partition Kit.** Horsebox style centre partition kit with all fittings, fits a TA5G 7'headroom 10' long without decks.
-  **KX0179 Centre Partition Kit.** Horsebox style centre partition kit with all fittings, fits a TA5G 7'headroom 12' & 14' with decks.
-  **KX0183 Centre Partition Kit.** Horsebox style centre partition kit with all fittings, fits a TA5G 7'headroom 12' without decks.
-  **KX0185 Centre Partition Kit.** Horsebox style centre partition kit with all fittings, fits a TA510G 7'headroom 10'long with decks.
-  **KX0186 Centre Partition Kit.** Horsebox style centre partition kit with all fittings, fits a TA510G 7'headroom 10' long without decks.
-  **KX0184 Centre Partition Kit.** Horsebox style centre partition kit with all fittings, fits a TA510G 7'headroom 12' & 14' with decks.
-  **KX0187 Centre Partition Kit.** Horsebox style centre partition kit with all fittings, fits a TA510G 7'headroom 12' without decks.

- AS7459 Fixing Bracket.** Fixes the centre partition pole to the trailer roof. 12' Trailers.
- AS7509 Fixing Bracket.** Fixes the centre pole to the trailer roof. 10' Trailers.
- C00077 Clevis Pin.** Used to secure the centre partition pole to the upper bracket (HB505/510 or TA5 models with horse kit).
- F1913Z R Clip.** Holds the centre partition clevis securely in place.
- C31250 Receiver Bracket.** Three hole breeching bar receiver bracket.
- AS4373 Fixing Plate.** Floor receiver for the centre pole, suitable for use on the sealed floor trailer.
- AS7588 Centre Partition Pole.** Compatible with the sealed floor trailers.

When transporting livestock, full use should be made of partitions to ensure that the animals are not thrown about by the motion of the vehicle. This is one of the provisions of the Transit of Animals Regulations, and it is most important for the safe towing of the trailer.

CATTLE CROSS DIVISIONS

Compatible with sealed floor trailers manufactured after June 2005



KX4765	TA5G 6' Headroom.
KX4765/7	TA5G 7' Headroom.
KX4766	TA510G 6' Headroom.
KX4766/7	TA510G 7' Headroom.
KX4767	DP120S.

SINGLE HEIGHT TRAILER CROSS DIVISIONS



KX4760	TA5G 4' Headroom.
KX4846	P6e. Fits the Livestock variant only.
KX4874	P6/P8G.
KX4874/5	P8G 5' Headroom.
KX8656	Q5.
1 KX8657	Q6, Q7 Series.

SMALL CROSS DIVISIONS

Compatible with sealed floor trailers manufactured after June 2005.



2 KX4750	TA5G 6' headroom Upper Cross Division.
KX4750/7	TA5G 7' headroom Upper Cross Division.
3 KX4751	TA5G Lower Cross Division.
KX4752	TA510G 6' headroom Upper Cross Division.
KX4752/7	TA510G 7' headroom Upper Cross Division.
KX4753	TA510G Lower Cross Division.
KX4754	DP120G Upper Cross Division.
KX4755	DP120G Lower Cross Division.

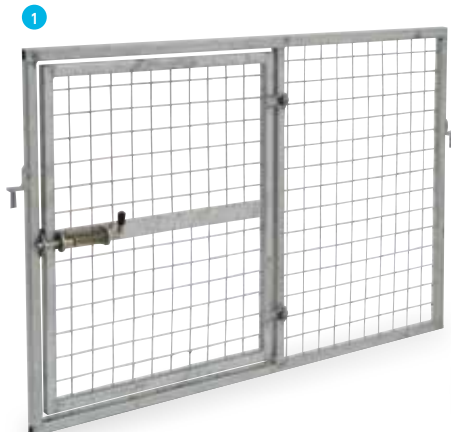

CROSS DIVISION COMPONENTS

- 1 AS5870 **Spring Bolt.** Fitted to the large cross divisions and the wooden P6e partition.
 - 2 C02005 **Cross Division Storage Retaining Pin.**
 - 3 C12006 **Cross Division Storage Pin Back Plate.** Fitted with C02005 to the centre of the front panel to hold a stowed cross division.
 - 4 C12005 **Cross Division Storage Lower Support Bracket.** Fitted to the bottom of front panel to support a stowed cross division.
 - 5 P1110/LS **Cross Division Storage Retaining Pin.**
 - 6 C04205 **Spring Bolt Shaft.** Used on the small cross divisions.
 - 7 C12001 **Slam Latch.** Fitted to the lower cross division.
 - 8 P1287 **Spring.** Used with the C12001 slam latch.
 - 9 C12009 **Sliding Catch.** Fits all current cattle cross divisions up to mid 2016.
P12871A **Reverse Spring.** Used with the C12009 sliding catch.
 - 11 AS2027 **Large Cross Division Main Latch Assembly.** Fitted from mid 2016. Can also be retro fitted to cattle cross divisions manufactured after June 2005 with the addition of items 12 & 13.
 - 12 C12002 **Bracket.** For use with C71975. Fitted from mid 2016 to the large cross divisions and to be introduced to small upper cross divisions.
 - 13 C17095 **C71975 Cross Division Nylon Guide.** Fitted from mid 2016 to the large cross divisions and to be introduced to small upper cross divisions.
 - 14 P1171 **Compression Spring.** Contained within the AS2027 latch.
P1284 **Compression Spring.** Used on the small upper cross divisions.
 - 15 KS4183 **Cross Division Pivot Bracket.** Fitted to the cattle and lower cross divisions TA5G & TA510G.
KS4184 **Cross Division Pivot Bracket.** Fitted to the cattle and lower cross divisions DP120G.
 - 16 P1015 **Door Stop Rubber.** Fitted to the large & upper cross divisions.
 - 17 P1022 **Mini Tie.** Fitted to the large & upper cross divisions.
 - 18 P1041 **S Hook.** Fitted to the large & upper cross divisions.
 - 19 P12361 **M8 Pin and Knob Moulded.** Fitted to the upper cross divisions and AS2027 latches.
- C498031-01705 **Aluminium Extrusion Vertical channel 1705mm.** Fits the KX4765 & KX4766 cattle cross divisions.
- C498031-02005 **Aluminium Extrusion Vertical channel 2005mm.** Fits the KX4765/7 & KX4766/7 cattle cross divisions.
- C498031-01725 **Aluminium Extrusion Vertical channel 1725mm.** Fits the KX4767 cattle cross divisions.



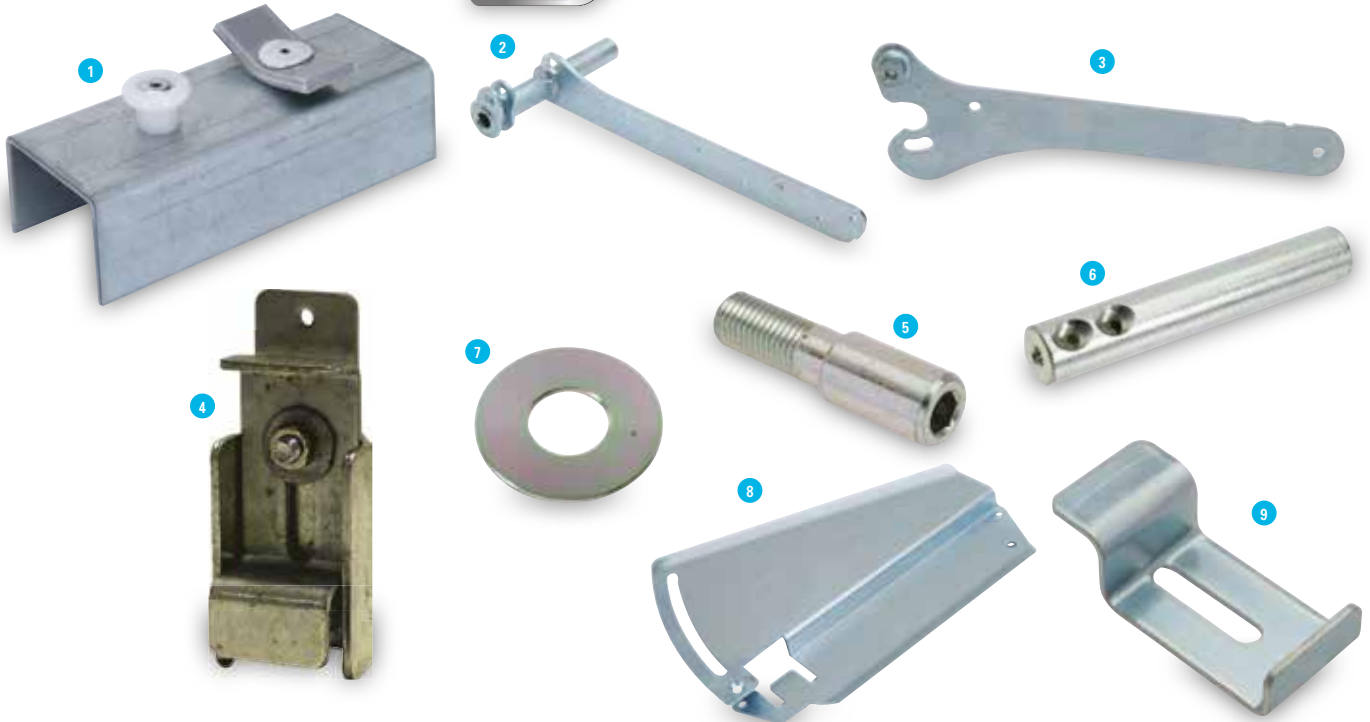

SHEEP DECK AND REAR BARRIER COMPONENTS











- 1 AS1963 Deck Barrier Slider Assembly.** Fitted to the front deck brace for stability when the decks are deployed, can also be used for securing lower cross divisions with the deck braces with out the use of decks.
- 2 AS1970 Drop Leaf Pivot.** Right hand.
- AS1971 Drop Leaf Pivot.** Left hand.
- 3 AS1975 Drop Leaf Support Leg.** Right hand.
- AS1976 Drop Leaf Support Leg.** Left hand.
- 4 AS4192 Deck Retainer.** Holds the folded deck in the raised position.
- 5 C01980 Spring Bolt End Male.** Makes up the spring bolt on the drop leaf pivot.
- 6 C01982 Spring Bolt End Female.** Makes up the spring bolt on the drop leaf pivot.
- 7 C01983 Spring Thrust Washer.** Makes up the spring bolt on the drop leaf pivot.
- 8 C12230 Drop Leaf Support.** Right hand.
- C12231 Drop Leaf Support.** Left hand.
- C12240 Deck Cross Brace.** TA5G.
- C12241 Deck Cross Brace.** TA510G.
- C12242 Deck Cross Brace.** DP120G.
- 9 C14193 Deck Retaining Catch.**
- 10 C14542 Deck Support Bracket.**
- 11 C44934 Treadplate Deck Hinge.**
- 12 C74217 Drop Leaf Deck Inner Bush.**
- 13 C74218 Drop Leaf Deck Outer Bush.**
- 14 C74219 Drop Leaf Slide Bush.**
- 15 C74419 Deck Pivot Bush.**
- 16 KS3210 Rear Barrier Retrofit Kit.** Enables the older version of rear barrier to be converted to the latest system.
- P0498 Galvanized Wire Rope.** Fitted to the rear barrier, sold per metre.
- 17 P10151 Top Hat Buffer.**
- 18 P1012S Door Holder.** Fitted to the rear barrier.
- 19 P1074 Butt Hinge.** Used to hinge the front deck.
- 20 P1075 Double Knuckle Deck Hinge.**
- 21 P1178 Compression Spring.** Used within the rear barrier mechanism.
- 22 P1188 Gas Spring.**
- 23 P1245 Deck Cleat.**





Model	Fixed deck system (up to Feb 2007)	Tilting deck system (Feb 2007 – early 2010)	Easy lift Tilting deck system (Early 2010 – present)
1 TA5G	AS1860	AS1960	AS1960-NB
TA510G	AS1861	AS1961	AS1961-NB
DP	AS1862	AS1962	AS1962-NB

C44190	Drop Leaf Rear Deck. TA5G used with the tilting deck system (Feb 2007 onwards) Final removable deck section.		
2 C44191	Drop Leaf Rear Deck. TA510G used with the tilting deck system (Feb 2007 onwards) Final removable deck section		
C44192	Drop Leaf Rear Deck. DP used with the tilting deck system (Feb 2007 onwards) Final removable deck section		

- 1** C04207 **Ramp Gate Spigot.** Used to secure the pivoting side of the ramp gate to the floor.
- 2** C14209 **Ramp Gate Extension locating Bracket.**
- C14343 **Back Rail Antiluce plate.**
- C14737 **Ramp Gate Bracket.** Right hand, Secures the ramp gates within the P*e, P*G & Q series.
- C14738 **Ramp Gate Bracket.** Left hand, Secures the ramp gates within the P*e, P*G & Q series.
- C14732 **Ramp Gate Catch.** Secures the ramp gates when in the closed position.
- 3** C24220 **Retaining Pin.** Used with the ramp gates and ramp gate extensions.
- 4** C49930 **Ramp Gate Pivot Hinge.**
- 5** C75363 **Capping Insert.**
-  KS0046 **Ramp Gate Kit.** 1 pair, fits the P*e, P*G & Q series.
-  KS2991 **Ramp Gate Kit.** 1 pair, Fits the TA5G.
-  KS29911 **Ramp Gate.** Right hand, Fits the TA5G.
-  KS29912 **Ramp Gate.** Left hand, Fits the TA5G.
-  KS2993 **Ramp Gate Kit.** 1 pair, Fits the TA510G.
-  KS29931 **Ramp Gate.** Right hand, Fits the TA510G.
-  KS29932 **Ramp Gate.** Left hand, Fits the TA510G.
-  KS2995 **Ramp Gate Kit.** 1 pair, Fits the DP120G.
-  KS29951 **Ramp Gate.** Right hand, Fits the DP120G.
-  KS29952 **Ramp Gate.** Left hand, Fits the DP120G.
-  KX8644 **Ramp Gate Kit.** Fits the Q range.
- C497930 **Ramp Gate Plank.** 1340mm, fits the TA5G ramp gates.
- C497950 **Ramp Gate Plank.** 1583mm, fits the TA510G ramp gates.
- C497954 **Ramp Gate Plank.** 1605mm, fits the DP120G ramp gates.



- C49933-01485 **Ramp Gate Channel.** 1485mm, fits the TA5G & TA510G ramp gates.
- C499446 **Ramp Gate Channel.** 1480mm, fits the DP120G ramp gates.
- KX4890 **Ramp Gate Extension.** 2' wide, fits the TA5G & TA510G.
- KX4891 **Ramp Gate Extension.** 4' wide, fits the DP120G.
- AS3040 **Back Rail.** Fits the P6e & P7e.
- KS2970 **Back Rail.** Single, fits the TA5G 6' low ramp.
- KS2971 **Back Rail.** Triple, fits the TA5G 7' low ramp and deck series.
- KS2974 **Back Rail.** Single, fits the TA510G 6' low ramp.
- KS2975 **Back Rail.** Triple, fits the TA510G 7' low ramp.
- KS2979 **Back Rail.** Fits the P*G 5'.





8 KX4950 DP Container Removal Kit. Includes 4 adjustable legs, adjustment tool, fittings & guide to remove and refit the DP container. For fitting to Tri-axle trailers please contact our technical department for guidance prior to purchase.



- 1 AS1711 Sump Tank Drain Cover Assembly.**
- 2 AS1712 Sump Tank Drain Point Assembly.**
- 3 C12032 Skid & Sump Tank Support. Right hand, fits the DP120S.**
C12033 Skid & Sump Tank Support. Left hand, fits the DP120S.
C12064 Sump Tank Floor Dam. TA510G.
- 4 C12065 Sump Tank Floor Dam. TA5G.**
- 5 KS4925 Sump Tank Screw Cap & Chain.**
P09400 Galvanized Strap. Secures the sump tanks, sold per metre.
- 6 KX4905 Sump Tank Kit. TA5G 8'** Includes plastic tank with two screw off caps, two drain points, rear dam and all fittings. This kit is a dealer fit only.
- 6 KX4900 Sump Tank Kit. TA5G 10' & 12'** Includes plastic tank with two screw off caps, two drain points, rear dam and all fittings. This kit is a dealer fit only.
- 6 KX4920 Sump Tank Kit. DP120S** Includes plastic tank with two screw off caps, two drain points and all fittings. This kit is a dealer fit only.
- 7 KX2160 GRP Wind Deflector (Fixed).** TA5G 6' & 7', the kit includes all fittings.
KX2162 GRP Wind Deflector (Fixed). TA510G 6', the kit includes all fittings.
KX2163 GRP Wind Deflector (Fixed). TA510G 7', the kit includes all fittings.
KX2164 GRP Wind Deflector (Fixed). DP120G, the kit includes all fittings.





TAILBOARDS & FITTINGS

	KS3109	Tailboard. GD4.
	KS3108	Tailboard. GD5.
	KS3110	Tailboard. GD6.
	1 AS0558	Hinge Tube. Fitted to the Tailboard and Ramp combinations.
	2 AS3140	Hinge Block Complete. Right hand, fitted to the tailboard and ramp combinations.
	AS3141	Hinge Block Complete. Left hand, fitted to the tailboard and ramp combinations.
	3 AS5870	Spring Bolt.
	C15300	Number Plate Panel. For the Tailboard.
	4 P1246	Hinge Pivot Bush. Fitted to the tailboard and ramp combinations.

RAMPS & FITTINGS

	KS3100	Ramp. GD4.
	KS3101	Ramp. GD5
	KX1501	Ramp. GD6.
	C15297	Number Plate Panel. For the Ramp.
	5 C30709	Ramp Fastener Handle. M14.
	6 P10885	Eye Bolt. M14.
	7 P1189	Gas Spring.
	P1192	Protective bellows.
	8 AS0598	Lower Gas Strut Bracket.
	9 C10640	Upper Gas Strut Bracket.

LADDER RACKS

	AS3120	Ladder Rack. GD4 – open framed design.
	AS3121	Ladder Rack. GD5 – open framed design.
	AS3142	Ladder Rack. GD6 – open framed design.

BODY PANELS, LIGHT BRACKETS & PILLARS

	C12101	Front Panel GD4.
	C12100	Front Panel GD5.
	C12095	Front Panel GD6.
	C12108	Right Hand Side Panel GD6.
	C12109	Left Hand Side Panel GD64.
	C12110	Right Hand Side Panel GD84/85.
	C12111	Left Hand Side Panel GD84/85.
	C12112	Right Hand Side Panel GD105/106.
	C12113	Left Hand Side Panel GD105/106.
	C12114	Right Hand Side Panel GD125/126.
	C12115	Left Hand Side Panel GD125/126.
	C14992	Vertical Channel. For Side Panel.
	AS3112	Rear Pillar. Right hand GD.
	AS3113	Rear Pillar. Left hand GD.
	10 AS3114	Light Bracket. Right hand GD.
	AS3115	Light Bracket. Left hand GD.

























MESH SIDE COMPONENTS

	AS3128	Mesh Side Panel. GD64 Right hand.
	AS3129	Mesh Side Panel. GD64 Left hand.
	AS3130	Mesh Side Panel. GD84/85 Right hand.
	AS3131	Mesh Side Panel. GD84/85 Left hand.
	AS3132	Mesh Side Panel. GD105/106 Right hand.
	AS3133	Mesh Side Panel. GD105/106 Left hand.
	AS3134	Mesh Side Panel. GD125/126 Right hand.
	AS3135	Mesh Side Panel. GD125/126 Left hand.
	AS3122	Ladder Rack. GD4' series - incorporating mesh panel.
	AS3123	Ladder Rack. GD5' series - incorporating mesh panel.
	AS3143	Ladder Rack. GD6' series - incorporating mesh panel.
	AS3124	Mesh Rear Panel. GD4 Series, used with mesh sides, the rear panel fits over the tailboard.
	AS3125	Mesh Rear Panel. GD5 Series, used with mesh sides, the rear panel fits over the tailboard.
	AS3126	Mesh Rear Panel. GD6 Series, used with mesh sides, the rear panel fits over the tailboard.
	C12105	Mesh Side Support. Right hand.
	11 C12106	Mesh Side Support. Left hand.

MESH SIDE KITS

	KX8000A	Mesh Side Kit. GD64 tailboard.
	KX8000	Mesh Side Kit. GD64 ramp.
	KX8002A	Mesh Side Kit. GD84 tailboard.
	KX8002	Mesh Side Kit. GD84 ramp.
	KX8003A	Mesh Side Kit. GD85 tailboard.
	KX8003	Mesh Side Kit. GD85 ramp.
	KX8004A	Mesh Side Kit. GD105 tailboard.
	KX8004	Mesh Side Kit. GD105 ramp.
	KX8006A	Mesh Side Kit. GD125 tailboard.
	KX8006	Mesh Side Kit. GD125 ramp.
	KX8008A	Mesh Side Kit. GD106 tailboard.
	KX8008	Mesh Side Kit. GD106 ramp.
	KX8009A	Mesh Side Kit. GD126 tailboard.
	KX8009	Mesh Side Kit. GD126 ramp.

DROPSIDE KITS

	KX1000 Dropside Kit LT/LM85G. Contains headboard, dropsides, tailboard, pillars and all fittings.
	KX1005 Dropside Kit LT/LM85G Ramp version. Contains headboard, dropsides and all fittings.
	KX1010 Dropside Kit LT/LM105G. Contains headboard, dropsides, tailboard, pillars and all fittings.
	KX1015 Dropside Kit LT/LM105G Ramp version. Contains headboard, dropsides, pillars and all fittings.
	KX1020 Dropside Kit LT/LM125G. Contains headboard, dropsides, tailboard, pillars and all fittings.
	KX1025 Dropside Kit LT/LM125G Ramp version. Contains headboard, dropsides, pillars and all fittings.
	KX1040 Dropside Kit LT/LM106G. Contains headboard, dropsides, tailboard, pillars and all fittings.
	KX1045 Dropside Kit LT/LM106G Ramp version. Contains headboard, dropsides, pillars and all fittings.
	KX1050 Dropside Kit LT/LM126G. Contains headboard, dropsides, tailboard, pillars and all fittings.
	KX1055 Dropside Kit LT/LM126G Ramp version. Contains headboard, dropsides, pillars and all fittings.
	KX1060 Dropside Kit LT/LM146G. Contains headboard, dropsides, tailboard, pillars and all fittings.
	KX1065 Dropside Kit LT/LM146G Ramp version. Contains headboard, dropsides, pillars and all fittings.
	KX1070 Dropside Kit LM166G. Contains headboard, dropsides, tailboard, pillars and all fittings.
	KX1072 Dropside Kit LM166G Ramp version. Contains headboard, dropsides, pillars and all fittings.
	KX1081 Dropside Kit LM186G. Contains headboard, dropsides, tailboard, pillars and all fittings.
	KX1085 Dropside Kit LM186G Ramp version. Contains headboard, dropsides, pillars and all fittings.
	KX1050/76 Dropside Kit LM127G. Contains headboard, dropsides, tailboard, pillars and all fittings.
	KX1055/76 Dropside Kit LM127G Ramp version. Contains headboard, dropsides, pillars and all fittings.
	KX1060/76 Dropside Kit LM147G. Contains headboard, dropsides, tailboard, pillars and all fittings.
	KX1065/76 Dropside Kit LM147G Ramp version. Contains headboard, dropsides, pillars and all fittings.
	KX1070/76 Dropside Kit LM167G. Contains headboard, dropsides, tailboard, pillars and all fittings.
	KX1073 Dropside Kit LM167G Ramp version. Contains headboard, dropsides, pillars and all fittings.
	KX1081/76 Dropside Kit LM187G. Contains headboard, dropsides, tailboard, pillars and all fittings.
	KX1085/76 Dropside Kit LM187G Ramp version. Contains headboard, dropsides, pillars and all fittings.
	KX1086 Dropside Kit LM208.



Dropside Kits & Components

INDIVIDUAL DROPSIDES

	AS2270 Dropside. LT/LM85G Right hand.
	AS2271 Dropside. LT/LM85G Left hand.
	AS2250 Dropside. LT/LM 10' Right hand.
	AS2251 Dropside. LT/LM 10' Left hand.
	AS2255 Dropside. LT/LM 12' Right hand.
	AS2256 Dropside. LT/LM 12' Left hand.
	AS2260 Dropside. LT/LM 14' Right hand.
	AS2261 Dropside. LT/LM 14' Left hand.
	AS2265 Dropside. LT/LM 16' Right hand.
	AS2266 Dropside. LT/LM 16' Left hand.

DROPSIDE FITTINGS

1	AS5190 Dropside Hinge. Right hand hinge on the right hand side panel.
	AS5191 Dropside Hinge. Left hand hinge on the right hand side panel.
	AS5195 Dropside Hinge. Centre hinge on the right hand side panel.
2	AS5192 Dropside Hinge. Right hand hinge on the left hand side panel.
	AS5193 Dropside Hinge. Left hand hinge on the left hand side panel.
3	AS5194 Dropside Hinge. Centre hinge on the left hand side panel.
	AS5262 Centre Pillar.
	AS5263 Right Hand Rear Pillar.
	AS5264 Left Hand Rear Pillar.







LM146 with KX1060 dropside kit fitted





Headboards, Tailboards,
Ladder Racks, Ramps
& Loading Skids







HEADBOARDS

	KX1100	Headboard. LT/LM85.
	KX1110	Headboard. LT/LM 1*5G.
	KX1120	Headboard. LM 1*6G.
	KX1120/76	Headboard. LM1*7G.
	KX1121	Headboard. LM208.







TAILBOARDS

	AS2160	Tailboard. LT/LM85G.
	AS2151	Tailboard. LT/LM 1*5G.
	AS2155	Tailboard. LT/LM 1*6G.
	AS2156	Tailboard. LM 1*7G
	AS5248	Tailboard. LM208





LADDER RACKS

	AS8416	Ladder Rack. LT/LM85G.
	AS8409	Ladder Rack. LT/LM1*5G
	AS8408	Ladder Rack. LT/LM 1*6G
	AS8449	Ladder Rack. LM 1*7G
	KX8445	Ladder Rack. LM208.

RAMP KITS

	KX1440	6' Ramp kit. LT/LM85G. LT/LM85G. Complete with pillars, springs and all fittings.
	KX1430	6' Ramp Kit. LT /LM 1*5G. Complete with pillars, springs and all fittings.
	KX1420	6' ramp Kit. LT/LM 1*6G. Complete with pillars, springs and all fittings.
	KX1420/76	6' Ramp Kit. LM 1*7G. Complete with pillars, springs and all fittings.
	AS5280	Ramp Pillar. Right hand.
	AS5281	Ramp Pillar. Left hand.

LOADING SKIDS

	1	KX5566	Loading Skids. One pair of 1.8m (6') perforated steel skids. Weight of each skid 27kg
	2	KX5568	Loading Skids. One pair of 2.5m (8') perforated steel skids. Weight of each skid 36kg
	3	KX5596	Loading Skids. One pair of 1.8m (6') lightweight aluminium skids. Weight of each skid 12.5kg
	4	KX5598	Loading Skids. One pair of 2.5m (8') lightweight aluminium skids. Weight of each skid 18kg.

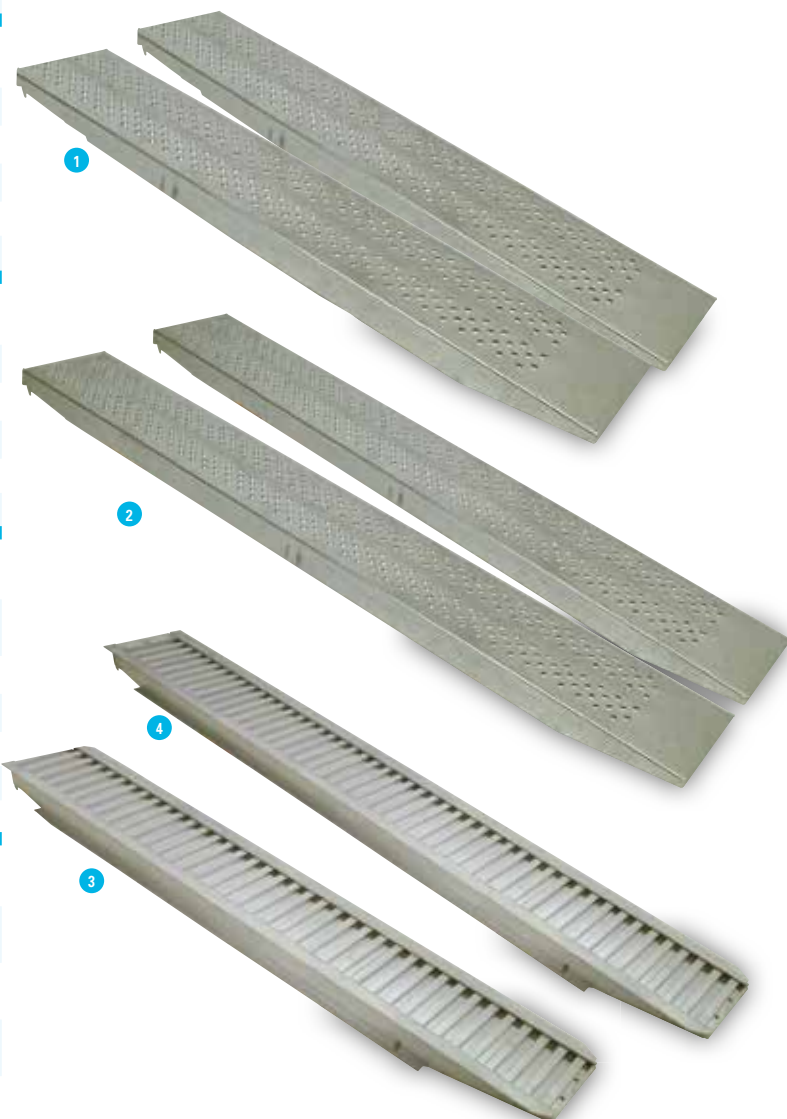



HINGED MESH SIDE KITS

	KX8450	Hinged Mesh Kit. For the LT/LM85G with a ramp fitted.	
	KX8451	Hinged Mesh Kit. For the LT/LM85G with a tailboard fitted.	
	KX8452	Hinged Mesh Kit. For the LT/LM105G with a ramp fitted.	
	KX8453	Hinged Mesh Kit. For the LT/LM105G with a tailboard fitted.	
	KX8454	Hinged Mesh Kit. For the LT/LM125G with a ramp fitted.	
	KX8455	Hinged Mesh Kit. For the LT/LM125G with a tailboard fitted.	
	KX8456	Hinged Mesh Kit. For the LT/LM106G with a ramp fitted.	
	KX8457	Hinged Mesh Kit. For the LT/LM106G with a tailboard fitted.	
	KX8458	Hinged Mesh Kit. For the LT/LM126G with a ramp fitted.	
	KX8459	Hinged Mesh Kit. For the LT/LM126G with a tailboard fitted.	
	KX8460	Hinged Mesh Kit. For the LT/LM146G with a ramp fitted.	
	KX8461	Hinged Mesh Kit. For the LT/LM146G with a tailboard fitted.	
	KX8466	Hinged Mesh Kit. For the LM127G with a ramp fitted.	
	KX8467	Hinged Mesh Kit. For the LM127G with a tailboard fitted.	
	KX8468	Hinged Mesh Kit. For the LM147G with a ramp fitted.	
	KX8469	Hinged Mesh Kit. For the LM147G with a tailboard fitted.	
	KX8470	Hinged Mesh Kit. For the LM167G with a ramp fitted.	
	KX8471	Hinged Mesh Kit. For the LM167G with a tailboard fitted.	
	KX8472	Hinged Mesh Kit. For the LM187G with a ramp fitted.	
	KX8473	Hinged Mesh Kit. For the LM187G with a tailboard fitted.	
	KX8474	Hinged Mesh Kit. For the LM208.	

HINGED MESH SIDE COMPONENTS

KS5270	Centre Pillar. Complete with all fittings.
KS5271	Rear Corner Pillar. Right hand, complete with all fittings.
KS5272	Rear Corner Pillar. Left hand, complete with all fittings.
AS5327	Hinged Mesh Side Panel. LT/LM 10'
AS5328	Hinged Mesh Side Panel. LT/LM 12'.
AS5329	Hinged Mesh Side Panel. LT/LM 14'.
AS5330	Hinged Mesh Side Panel. LM 16'
AS5331	Hinged Mesh Side Panel. LM 18'
AS5332	Hinged Mesh Side Panel. LT/LM85G.
AS5333	Hinged Mesh Rear Panel. LT/LM85G.
AS5334	Hinged Mesh Rear Panel. LT/LM105G.
AS5335	Hinged Mesh Rear Panel. LT/LM1*6G.
AS5336	Hinged Mesh Rear Panel. LM1*7G.
AS5337	Hinged Rear Mesh Panel. LM208.
AS5338	Mesh Ladder Rack. LT/LM85G.
AS5339	Mesh Ladder Rack. LT/LM105G.
AS5340	Mesh Ladder Rack. LT/LM1*6G.
AS5341	Mesh Ladder Rack. LM1*7G.
AS5342	Mesh Ladder Rack. LM208.

DRAWBARS

-  **1** AS7246 **Drawbar Set.** LT/LM85 – complete Left and Right hand drawbar assemblies.
- AS7232 **Drawbar Set.** LT/LM 5 series – complete Left and Right hand drawbar assemblies.
- AS7237 **Drawbar Set.** LT/LM 6 series – complete Left and Right hand drawbar assemblies.
- AS7230 **Drawbar Set.** LT/LM 7 series – complete Left and Right hand drawbar assemblies.

SUSPENSION CROSS MEMBERS

- 2** AS0940A **Suspension Cross Member.** Front LT/LM 85G.
- AS0940B **Suspension Cross Member.** Middle/rear LT/LM85G.
- AS0935A **Suspension Cross Member.** Front LT/LM105G/125G.
- AS0935B **Suspension Cross Member.** Middle LT/LM105G/125G.
- AS0935C **Suspension Cross Member.** Rear LT/LM105G/125G.
- AS0930A **Suspension Cross Member.** Front LM 6.
- AS0930B **Suspension Cross Member.** Middle LM 6.
- AS0930C **Suspension Cross Member.** Rear LM 6 (middle & rear on LM6 Tri-axle models).
- AS0945A **Suspension Cross Member.** Front LM 7.
- AS0945B **Suspension Cross Member.** Middle LM 7.
- AS0945C **Suspension Cross Member.** Rear LM 7 (middle & rear on LM 7 Tri-axle models).

FLOOR CAPPING

- C15004 **Rear Floor Capping.** LT/LM85G. Forms a protective edge to the ply floor.
- C15002 **Rear Floor Capping.** LT/LM 1*5G. Forms a protective edge to the ply floor.
- C15001 **Rear Floor Capping.** LT/LM 1*6G. Forms a protective edge to the ply floor.
- C14996 **Rear Floor Capping.** LT/LM 1*7G. Forms a protective edge to the ply floor.

Drawbars, Suspension Cross Members, Floor Capping & Lighting Plates



LIGHTING PLATES

- C10199 **Lighting Plate.** LT/LM85G. Pre formed plate to which the rear lights are mounted.
- C10200 **Lighting Plate.** LT/LM1*5G. Pre formed plate to which the rear lights are mounted.
- C10201 **Lighting Plate.** LT/LM1*6G. Pre formed plate to which the rear lights are mounted.
- C10203 **Lighting Plate.** LT/LM1*7G. Pre formed plate to which the rear lights are mounted.

MUDGUARD KITS











These kits allow you to fit the latest, single axle mudguards to your trailer. All fittings supplied.

- KS159302 **Muduard Kit.** Compatible with the twin axle LT/LM.
- KS159303 **Muduard Kit.** Compatible with the tri axle LT/LM.
- KS1593025 **Mudguard Kit.** Compatible with the twin axle LT/LM85G.









STEEL DROPSIDE KITS & COMPONENTS

-  **KX3100 Steel Dropside Kit.** Dropsides & pillars for EL101-2012.
-  **KX3120 Steel Dropside Kit.** Dropsides & pillars for EL101-2512 & EL142-2512.
-  **KX3130 Steel Dropside Kit.** Dropsides & pillars for EL101-2515, EL141-2515, EL142-2515 & EX202-2515.
-  **KX3150 Steel Dropside Kit.** Dropsides & pillars for EL142-3015 & EX202-3015.
-  **KX3160 Steel Dropside Kit.** Dropsides & pillars for EL142-3615 & EX202-3615.
-  **KX3095 Steel Headboard Kit.** For all 1.2m wide Eurolight models.
-  **KX3096 Steel Headboard Kit.** For all 1.5m wide Eurolight models.
-  **AS2322 Steel Dropside / Tailboard Assembly.** 1.2m long.
-  **AS2323 Steel Dropside / Tailboard Assembly.** 1.5m long.
-  **AS2331 Steel Dropside.** 1.73m long.
- AS2528 Corner Post.** Fitted front and rear within the dropside kits.
- AS2565 Centre Post.**
- 1 AS2554 Receiver Bracket.** To secure the centre post.
- AS5198 Vertical Dropside Hinge.** Right hand.
- AS5199 Vertical Dropside Hinge.** Left hand.

MESH SIDE KITS

-  **KX3350 Mesh Side Kit.** Includes all fittings for EL101-2012.
-  **KX3352 Mesh Side Kit.** Includes all fittings for EL101-2512 & EL142-2512.
-  **KX3362 Mesh Side Kit.** Includes all fittings for EL101-2515, EL141-2515, EL142-2515 & EX202-2515.
-  **KX3364 Mesh Side Kit.** Includes all fittings for EL142-3015 & EX202-3015.
-  **KX3366 Mesh Side Kit.** Includes all fittings for EL142-3615 & EX202-3615.



ADDITIONAL ACCESSORIES



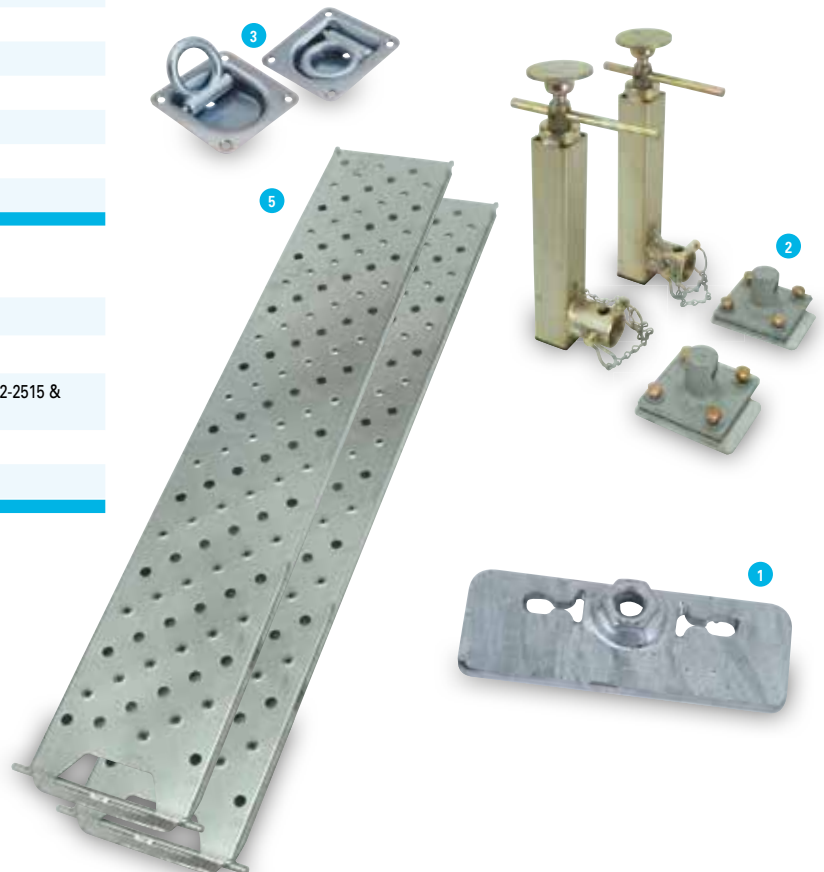



-  **KX3240 Ladder Rack Kit.** For all 1.2m wide Eurolight models.
-  **KX3250 Ladder Rack Kit.** For all 1.5m wide Eurolight models.
- 2 KX3185 Propstand Kit.** Pair - for all Eurolight models.
- 3 KX3190 Lashing Ring Kit.** Pair - for all Eurolight models.
- 4 KX3192 Rope Hook Kit.** Pair - extra pair of ropehooks for all Eurolight models.
-  **KX3200 Skid Stowage Kit A.** For EL101-2012, EL142-2012, EL142-2515 & EX202-2515. Distributor supply & fit only.
-  **KX3210 Skid Stowage Kit B.** For EL101-2512, EL101-2515, EL141-2515, EL142-3015, EL142-3615, EX202-3015 & EX202-3615. Distributor supply & fit only
-  **5 KX3180 2.0m Loading Skid.** Pair - for all Eurolight models (where skid stowage kit fitted). Load rating of 450kg per skid. Weight of each skid 22.2kg





Parts and accessories
for Beavertail trailers
manufactured since
January 2013



DROPSIDE KITS

	KX1161 Dropside Kit. LM/LT146B2. Contains headboard, tailboard, dropsides, pillars and all fittings.
	KX1162 Dropside Kit. LM/LT146B2 with ramp already fitted. Contains headboard, dropsides, pillars and all fittings.
	KX1165 Dropside Kit. LM166B2. Contains headboard, tailboard, dropsides, pillars and all fittings.
	KX1166 Dropside Kit. LM166B2 with ramp already fitted. Contains headboard, dropsides, pillars and all fittings.
	KX1163 Dropside Kit. LM147B2. Contains headboard, tailboard, dropsides, pillars and all fittings.
	KX1164 Dropside Kit. LM147B2 with ramp already fitted. Contains headboard, dropsides, pillars and all fittings.
	KX1167 Dropside Kit. LM167B2. Contains headboard, tailboard, dropsides, pillars and all fittings.
	KX1168 Dropside Kit. LM167B2 with ramp already fitted. Contains headboard, dropsides, pillars and all fittings.

HINGED MESH SIDE KITS

	KX8461 Hinged Mesh Kit. LT/LM146B2. Tailboard.
	KX8460 Hinged Mesh Kit. LT/LM146B2. Ramp.
	KX8463 Hinged Mesh Kit. LM166B2. Tailboard.
	KX8462 Hinged Mesh Kit. LM166B2. Ramp.
	KX8469 Hinged Mesh Kit. LM147B2. Tailboard.
	KX8468 Hinged Mesh Kit. LM147B2. Ramp.
	KX8471 Hinged Mesh Kit. LM167B2. Tailboard.
	KX8470 Hinged Mesh Kit. LM167B2. Ramp.

HEADBOARDS, LADDER RACKS, TAILBOARDS, RAMPS & LOADING SKIDS

KX1120 Headboard. LM6B2.
KX1120/76 Headboard. LM7B2.
KX8408 Ladder Rack. LM6B2.
KX8449 Ladder Rack. LM7B2.
AS2166 Tailboard. LM6B2.
AS2167 Tailboard. LM7B2.
KX1468 6'Ramp kit. LM6B2. For a trailer without drop sides fitted. Contains with hinges, pillars, springs and all fittings.
KX1473 6'Ramp kit. LM6B2. For a trailer with drop sides fitted. Contains hinges, pillars, springs and all fittings.
KX1471 6'Ramp with gas strut kit. LM6B2. Contains hinges, gas strut brackets, ramp stays, and gas strut.
KX1469 6'Ramp kit. LM7B2. For a trailer without drop sides fitted. Contains with hinges, pillars, springs and all fittings.
KX1474 6'Ramp kit. LM7B2. For a trailer with drop sides fitted. Contains hinges, pillars, springs and all fittings.
KX1472 6'Ramp with gas strut kit. LM7B2. Contains hinges, gas strut brackets, ramp stays, and gas strut.
KX5566 Loading Skids. One pair of 1.8m (6') perforated steel skids.
KX5596 Loading Skids. One pair of 1.8m (6') lightweight aluminium skids.
KX1476-2 Skid Rack Kit. LT/LM6B2. To carry one pair of skids in the stowed position.
KX1477-2 Skid Rack Kit. LM7B2. To carry one pair of skids in the stowed position.
KX1475 Skid Rack Kit. LT/LM6/7B2. To carry one additional skid in the stowed position.













FLOOR CAPPINGS

C40030 Beavertail floor cover strip 6'6"
C40006 Beavertail floor cover strip 7'6"

**CT166 &
CT167**







DROPSIDE KITS, MESHSIDE KITS, RAMPS & TAILBOARDS

	KX1072	Dropside Kit. Compatible with the CT166, contains four drop sides, headboard, pillars and fittings.
	KX1073	Dropside Kit. Compatible with the CT167, contains four drop sides, headboard, pillars and fittings.
	KX1120A	Headboard. Compatible with the CT166.
	KX1120/76A	Headboard. Compatible with the CT167.
	KX8408A	Ladder Rack. Compatible with the CT166.
	KX8449A	Ladder Rack. Compatible with the CT167.
	KX8463	Hinged Mesh Side Kit. Compatible with the CT166.
	KX8471	Hinged Mesh Side Kit. Compatible with the CT167.
	KX1460	Tailboard / Ramp 3'. Compatible with the CT166, supplied with gas strut.
	KX1461	Standard Tailboard. Compatible with the CT166.
	KX1460/76	Tailboard / Ramp 3'. Compatible with the CT167, supplied with gas strut.
	KX1466	Standard Tailboard. Compatible with the CT167.
	AS5263	Rear Corner Pillar. Right hand, compatible with the tailboard and ramp.
	AS5264	Rear Corner Pillar. Left hand, compatible with the tailboard and ramp.
	C17264	Gas Strut Mounting Bracket. Lower.
	P1189	Gas Spring. Fitted to the 3' ramp.

MANUAL PUMP AND HYDRAULICS













	P11415	Manual Pump.
	P11415H	Manual Pump Handle.
	P11306	Socket Casting.
	P11308	Filler Cap.
	P11309	Release Valve.
	P1139	Hydraulic Ram.
	AS7285	Hydraulic Hose Kit.

BODY FITTINGS









	AS7251	Drawbar Assembly. Compatible with the CT166 & CT167.
	AS7261	Rear Support Bracket. Bolted to the chassis, to protect the body when tilted.
	P1011	Body Clamp. Fitted to the drawbar to secure the upper body.
	P1011P	Body Clamp Receiver Plate.



DROPSIDE KITS





-  **KX6208-40** **Dropside Kit.** This kit includes dropsides, centre pillars and fittings only, no headboard, tailboard or ramp. Compatible with the 4m TB mk1 & mk2.
-  **KX6208-46** **Dropside Kit.** This kit includes dropsides, centre pillars and fittings only, no headboard, tailboard or ramp. Compatible with the 4.6m TB mk1 & mk2.
-  **KX6208-50** **Dropside Kit.** This kit includes dropsides, centre pillars and fittings only, no headboard, tailboard or ramp. Compatible with the 5m TB mk1 & mk2.
-  **KX6208-55** **Dropside Kit.** This kit includes dropsides, centre pillars and fittings only, no headboard, tailboard or ramp. Compatible with the 5.5m TB mk1 & mk2.
-  **KX62112-4021** **Dropside Kit.** This kit includes headboard, dropsides, mesh ramp & all fittings. Compatible with the TB4021 mk2.
-  **KX62112-4621** **Dropside Kit.** This kit includes headboard, dropsides, mesh ramp & all fittings. Compatible with the TB4621mk2.
-  **KX62112-5021** **Dropside Kit.** This kit includes headboard, dropsides, mesh ramp & all fittings. Compatible with the TB5021 mk2.
-  **KX62112-5621** **Dropside Kit.** This kit includes headboard, dropsides, mesh ramp & all fittings. Compatible with the TB5521 mk2.
-  **KX62212-4021** **Dropside Kit.** This kit includes headboard, dropsides, tailboard & all fittings. Compatible with the TB4021 mk2.
-  **KX62212-4621** **Dropside Kit.** This kit includes headboard, dropsides, tailboard & all fittings. Compatible with the TB4621 mk2.
-  **KX62212-5021** **Dropside Kit.** This kit includes headboard, dropsides, tailboard & all fittings. Compatible with the TB5021mk2.
-  **KX62212-5621** **Dropside Kit.** This kit includes headboard, dropsides, tailboard & all fittings. Compatible with the TB5521 mk2.

MESH SIDE KITS





-  **KX62122-4021** **Mesh Side Kit.** For a trailer with a mesh ramp already fitted. Compatible with the TB4021mk 2.
-  **KX62122-4621** **Mesh Side kit.** For a trailer with a mesh ramp already fitted. Compatible with the TB4621 mk2.
-  **KX62122-5021** **Mesh Side kit.** For a trailer with a mesh ramp already fitted. Compatible with the TB5021 mk2.
-  **KX62122-5521** **Mesh Side Kit.** For a trailer with a mesh ramp already fitted. Compatible with the TB5521mk2.
-  **KX62222-4021** **Mesh Side kit.** For a trailer with a tailboard fitted. Compatible with the TB4021 mk2.
-  **KX62222-4621** **Mesh Side kit.** For a trailer with a tailboard fitted. Compatible with the TB4621 mk2.
-  **KX62222-5021** **Mesh Side kit.** For a trailer with a tailboard fitted. Compatible with the TB5021 mk2.
-  **KX62222-5521** **Mesh Side Kit.** For a trailer with a tailboard fitted. Compatible with the TB5521 mk2.

The TB mk 2 was introduced in late 2010, it is identifiable by the round rear lights and the wavy ramps and skids. The TB mk 1 had square/rectangular rear lights.

RAMP, SKID & TAILBOARD KITS

-  **KX62132-21** **Mesh Ramp.** This ramp is the optimal shape to maximise clearance to the splitter of a vehicle during loading. The ramp is all mesh, which permits visibility of the rear tail lights when the ramp is deployed. Supplied with rear pillars. The kit includes gas spring and all fittings. Compatible with the TB mk2.
-  **KX62022** **Removable Skid Kit & Carrier.** Compatible with the TB mk2. Removable steel skids which can be positioned to your required width to suit the vehicle being loaded. Skids are stored in the carrier, accessed from behind the number plate. The option of removable skids offers a more fuel efficient alternative to fixed skids or ramp through reduced drag when towing.
-  **KX62032** **Hinged Mesh Skid kit.** Compatible with the TB mk2. Suitable for users that not require a full width ramp. Fold-out side posts can be deployed if additional width is required when loading.
-  **KX62202-21** **Tailboard.** Drop in tailboard kit. Compatible with the TB mk2.

ACCESSORIES

-  **KX6207-21** **Headboard.** Compatible with the TB mk1 & mk2.
-  **KX6223-21** **Ladder Rack.**
-  **KX6205-21** **Wheel Chock Kit.** For customers who will be predominantly transporting vehicles on their Tiltbed. Wheel chocks prevent the forward movement of the vehicle when being transported on the trailer. Multiple setting positions can be adjusted enabling convenient positioning of the vehicle. This kit cannot be fitted with drop sides. Compatible with a TB mk1 & mk2.
-  **KX6206-40** **Raised Rave Kit.** Compatible with the 4m TB mk1 & mk2. This kit comprises of 2 galvanised steel pressings that bolt to the existing holes on the trailer. They give the user an indication that the tyre of the vehicle being loaded is close to the edge.

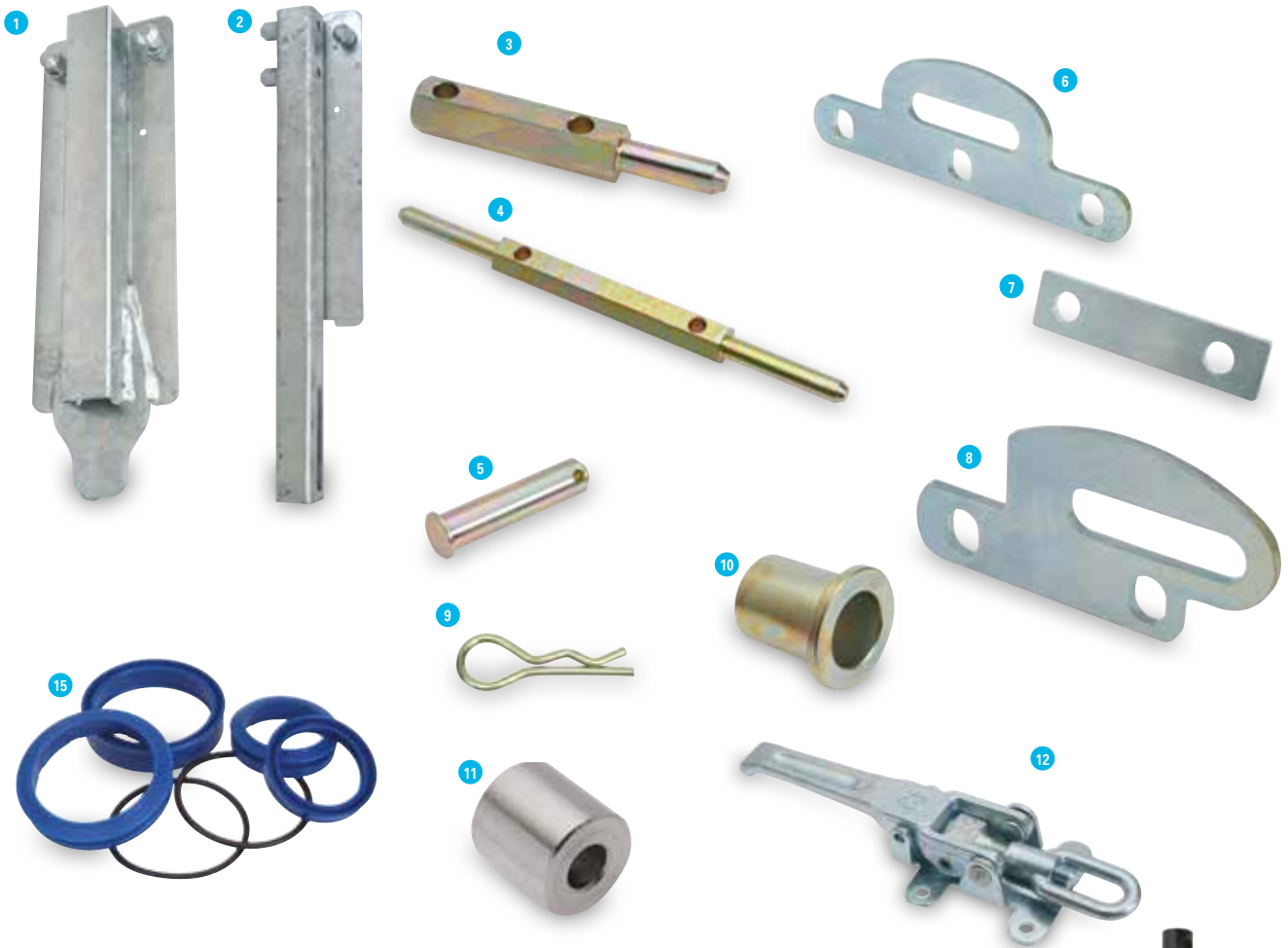

DROP SIDE COMPONENTS

1	AS7032	Centre Post.
2	AS7095	Rear Corner Post. Right hand.
	AS7096	Rear Corner Post. Left hand.
3	C07004	Sideboard Pivot Bar- End.
4	C07005	Sideboard Pivot Bar- Centre.
5	C07010	Rear Post Pin.
6	C17093	Sideboard Post Adjusting Plate.
7	C17094	Sideboard Hinge Spacer Plate.
8	C17095	Sideboard Post Adjusting Plate Rear.
9	F1913Z	R-Pin.

DEDICATED SPARES

	AS7029	Drawbar. Compatible with the 4.6, 5 & 5.5m TB.
	AS7030	Drawbar. Compatible with the 4m TB.
10	C07003	Hinge Pivot Bush.
11	C47001	Rope Hook Spacer.
12	P1087HD	Body Clamp.

HYDRAULIC SPARES



13	AS7286	Hydraulic Hose & Fitting Kit.
14	P11316	Hydraulic Ram.
15	P113175	Seal Kit. For the P11316 ram.
16	P11415	Manual Pump.

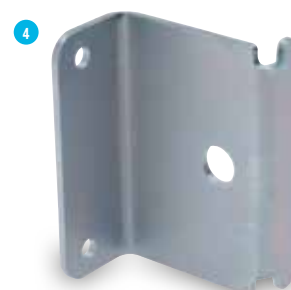

Mesh & Solid Side Kits & Components



MESH SIDE KITS















-  **KX6300-2515** **Mesh Side Kit.** TT2515, the kit includes ladder rack, front mesh panel, mesh side panels, rear mesh panel, pillars and all fittings.
-  **KX6300-3017** **Mesh Side Kit.** TT3017, the kit includes ladder rack, front mesh panel, mesh side panels, rear mesh panel, pillars and all fittings.
-  **KX6300-3621** **Mesh Side Kit.** TT3621, the kit includes ladder rack, front mesh panel, mesh side panels, rear mesh panel, pillars and all fittings.

SOLID SIDE KITS

Similar to the mesh kit but with aluminium infilled sides, ideal for carrying small or loose products.









-  **KX6305-2515** **Solid Side Extension Kit.** TT2515. The kit includes infilled ladder rack, side and rear panels, pillars and all fittings.
-  **KX6305-3017** **Solid Side Extension Kit.** TT3017. The kit includes infilled ladder rack, side and rear panels, pillars and all fittings.
-  **KX6305-3621** **Solid Side Extension Kit.** TT3621. The kit includes infilled ladder rack, side and rear panels, pillars and all fittings.

MESH SIDE COMPONENTS

- AS4477** **Extended Rear Corner Pillar.** Left hand, used within the extended solid and mesh side kits.
- AS4478** **Extended Rear Corner Pillar.** Right hand, used within the extended solid and mesh side kits.
- AS7085** **Extended Centre Pillar.** TT3017 & 3621, used within the extended solid and mesh side kits.
-  **AS4479** **Rear Mesh Panel.** TT2515, fits above the tailboard.
-  **AS4480** **Rear Mesh Panel.** TT3017, fits above the tailboard.
-  **AS4481** **Rear Mesh Panel.** TT3621, fits above the tailboard.
-  **AS4485** **Front Mesh Panel.** TT2515, fits within the ladder rack.
-  **AS4486** **Front Mesh Panel.** TT3017, fits within the ladder rack.
-  **AS4487** **Front Mesh Panel.** TT3621, fits within the ladder rack.
-  **AS7093** **Mesh Side Panel.** TT2515.
-  **AS7069** **Mesh Side Panel.** TT3017.
-  **AS7092** **Mesh Side Panel.** TT3621.
-  **AS7094** **Lateral Brace.** TT3017.
- AS7088** **Lateral Brace.** TT3621.
-  **C04248** **U-Bolt.**
-  **C17199** **Hinge Hook - Front.**
-  **C17201** **Bracket- Mesh Tailgate Catch.**
-  **C17202** **Catch - Mesh Tailgate.**
-  **P1098** **Stainless Steel Linch Pin & Chain.**













DROPSIDES, HEADBOARDS & TAILBOARDS









- | | | |
|--|---------|--|
| 1 | AS4460 | Tailboard Locking Bar. TT2515 |
| | AS4461 | Tailboard Locking Bar. TT3017 |
| | AS4462 | Tailboard Locking Bar. TT3621 |
| 2 | AS5236 | Centre Post. |
| 3 | AS7163 | Bolt On Drop Side Hinge Receiver. Left Hand |
| | AS7164 | Bolt On Drop Side Hinge Receiver. Right Hand |
|  | AS7165 | Drop Side. TT2515. |
|  | AS7166 | Drop Side. TT3017. |
|  | AS7167 | Drop Side. TT3621. |
|  | AS7170 | Headboard. TT2515. |
|  | AS7171 | Headboard. TT3017. |
|  | AS7172 | Headboard. TT3621. |
|  | KS31232 | Tailboard. TT2515 |
|  | KS31234 | Tailboard. TT3017 |
|  | KS31236 | Tailboard. TT3621 |
| 4 | KS4491 | Rear Corner Post. Complete, Left hand. |
| | KS4492 | Rear Corner Post. Complete, right hand. |
| 5 | P1098 | Stainless Steel Linch Pin & Chain. |



ACCESSORIES

-  **KX6310-15** Ladder Rack. TT2515.
-  **KX6310-17** Ladder Rack. TT3017.
-  **KX6310-21** Ladder Rack. TT3621.
-  **KX6315-15** Skid Holder. TT2515. An optional Accessory for stowing loading skids.
-  **KX6315** Skid Holder. TT3017 & TT3621. An optional Accessory for stowing loading skids.
-  **KX6317** Toolbox. Lockable, ideal for carrying loose items.
-  **KX6318** Floor Mounted Lashing Point Kit. One individual, rated at 500kg, Recommended when carrying items of plant.
-  **KX6319** Lamp Guards. One pair, road legal, offers further protection for the rear lights when tipping loads.
-  **KX5568** Steel Loading Skids. One Pair, 2.4m (8') long, can be used to permit the loading of wheeled and tracked plant equipment.
-  **KX5598** Aluminium Loading Skids. One Pair, 2.4m (8') long, can be used to permit the loading of wheeled and tracked plant equipment.
-  **KX6316** Propstand Kit. One pair of fold down propstand legs. To be used with the loading skids for loading and unloading plant.

DEDICATED SPARES

-  **AS4433** Body Prop.
-  **AS4445** Aluminium Floor. Fitted as standard to the TT2515.
-  **AS4446** Aluminium Floor. Fitted as standard to the TT3017.
-  **AS4447** Aluminium Floor. Fitted as standard to the TT3621.
-  **KS31252** Drawbar Kit. TT2515.
-  **KS31254** Drawbar Kit. TT3017.
-  **KS31256** Drawbar Kit. TT3621.
- KS4100** Lockable Electrical Enclosure Box.
-  **P10565** Lock & Keys. Replacement lock & keys for the tool box and electrical enclosure box.
-  **P10567** Lock Cam. Used with the P10565 lock for the tool box and electrical enclosure box.



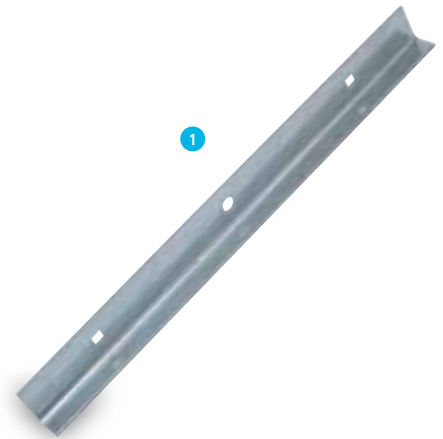

AS7286 Hydraulic Hose & Fitting Kit. Compatible with the manual TT2515 & TT85G.

C13506 Manual Pump Mounting Bracket. Compatible with the manual TT2515.

1 C15507 Battery Clamp Plate. Compatible with the current and older tipper models.

2 P0655 Sealed Battery. 12v 105Ah 800a.

3 P0656 Battery Terminal Nuts.

4 P11305 Manual Pump. Fitted to the manual TT85G & TT2515.

5 P11306 Manual Pump Socket Casting. Compatible with the P11305 & P11415 manual pumps.

6 P11308 Filler / Breather Cap. Compatible with the P11305 & P11415 manual pumps.

7 P11309 Release valve. Compatible with the P11305 & P11415 manual pumps.

8 P11415H Manual Pump Handle. Compatible with the P11305 & P11415 manual pumps.

9 P1131 Hydraulic Ram. Compatible with the TT2515 & TT85.

10 P11310 Hydraulic Ram. Compatible with the TT3017, TT3621, TT105 & TT126.

11 P11311 Seal Kit. Compatible with the P11310 hydraulic ram.

P11312 Seal Kit. Compatible with the P1131 hydraulic ram.

This Power pack unit has been fitted to the tipper range since January 2013



- 1 P11976 Savery 12v Hydraulic Power Pack.
- 2 P1197601 12v Electric Motor.
- 3 P1197602 Solenoid – Electric Motor Starter.
- 4 P1197603 R Gear Pump.
- 5 P1197604 Solenoid Down Valve.
- 6 P1197605 Solenoid Valve Coil.
- 7 P1197606 Check Valve.
- 8 P1197607 Relief Valve.
- 9 P1197608 Hand Pump.
- 10 P1197609 Hand Pump Handle.
- 11 P1197610 Plastic Cover.
- 12 P1197611 Plastic Tank.
- 13 P1197612 Remote Control.
- 14 P1197613 Strainer.
- 15 P1197614 Drive Coupling.
- 16 P1197615 Pressure Hose.
- 17 P1197616 O-Ring Spigot Seal.
- 18 P1197617 Manifold Block.
- 19 P1197618 6.0 SK Seal.
- 20 P1197619 8.0 SK Seal.
- 21 P1197620 O Ring.
- 22 P1197622 Cable 1.6/ 2.2kw / In line Fuse Cable.

**TT85G,
TT105G &
TT126G**

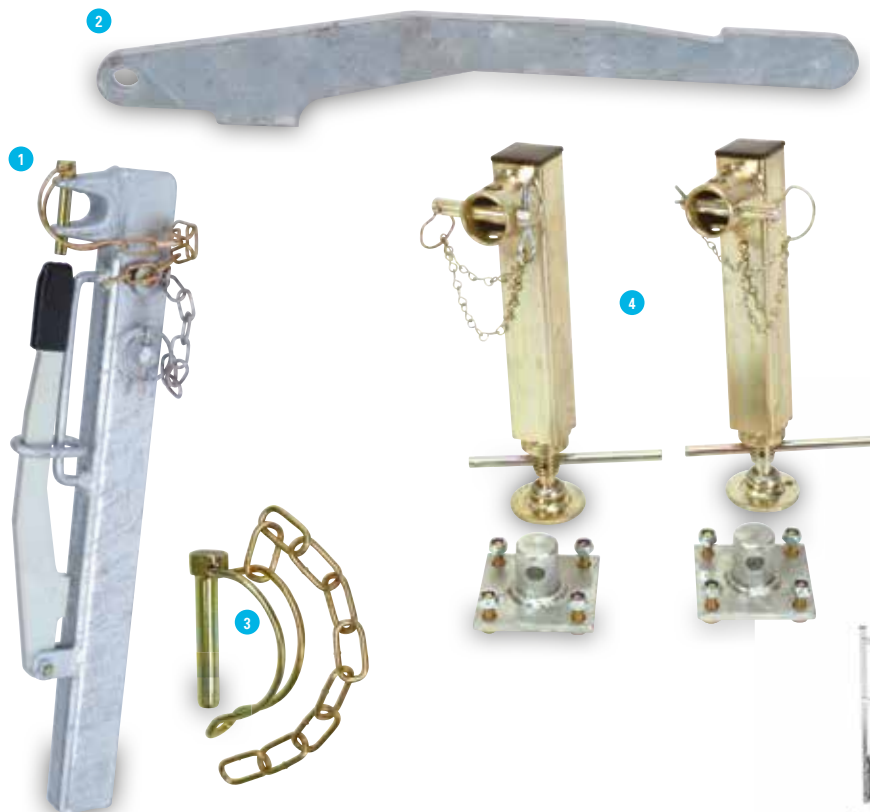

DROPSIDES, HEADBOARDS & TAILBOARDS

	AS2175	Tailboard. TT85G (post May 2000).	
	AS2176	Tailboard. TT105G.	
	KS0332	Tailboard. TT126G.	
	AS2216	Headboard. TT85G Incorporates ladder rack.	
	KX1110	Headboard. TT105G.	
	KX1120	Headboard. TT126G.	
	AS2270	Dropside. Right hand side TT85G.	
	AS2271	Dropside. Left hand side TT85G.	
	AS2250	Dropside. Right hand side TT105G.	
	AS2251	Dropside. Left hand side TT105G.	
	AS2255	Dropside. Right hand side TT126G.	
	AS2256	Dropside. Left hand side TT126G.	
	1 KS5041	Rear Pillar. Right hand side for TT126G, TT105G & TT85G (post May 2000) Complete with locking handle and linch pin.	
	KS5042	Rear Pillar. Left hand side for TT126G, TT105G & TT85G (post May 2000) Complete with locking handle and linch pin.	

DEDICATED SPARES

	AS7205	Drawbar. One pair, compatible with the TT126G.	
	AS7230	Drawbar. One pair, compatible with the TT105G.	
	2 C00178	Tailboard Locking Handle. Used on the standard and mesh rear pillars to secure the tailboard.	
	P1194	Plastic End Cap. Fitted to the C00178 locking handle.	
	3 P1096	Linch Pin. Used to secure the tailboard.	
	4 KX0227	Propstand Kit. One pair of propstands, with bolt on spigots and fitting kit.	

MESH SIDE KITS

KX8570	Mesh Side Kit. TT85 Mesh side kit including mesh ladder rack, rear panel and all fittings. For trailers fitted with a tailboard.
KX8581	Mesh Side Kit. TT105 Split mesh side kit including mesh ladder rack, rear panel and all fittings. For trailers fitted with a tailboard.
KX8586	Mesh Side Kit. TT126 Split mesh side kit including mesh ladder rack, rear panel and all fittings. For trailers fitted with a tailboard.

MESH SIDE COMPONENTS

AS9782	Mesh Side Panel. TT85 Individual mesh side panel.
AS9780	Mesh Front Panel. For use with mesh sides, fits over the fixed ladder rack on the TT85 models.
AS9781	Mesh Rear Panel. TT85G, Used with mesh sides, the rear panel fits over the tailboard.
AS0187	Mesh Rear Panel. TT105, Used with mesh sides, the rear panel fits over the tailboard.
AS0700	Mesh Rear Panel. TT126, Used with mesh sides, the rear panel fits over the tailboard.
KS5045	Rear Mesh Pillar. Right hand side for TT85G (post May 2000) Includes locking handle and linch pin.
KS5046	Rear Mesh Pillar. Left hand side for TT85G (post May 2000) Includes locking handle and linch pin.
KS5043	Rear Mesh Pillar. Right hand side for TT105G & TT126G Includes locking handle and linch pin.
KS5044	Rear Mesh Pillar. Left hand side for TT105G & TT126G Includes locking handle and linch pin.
KS5266	Centre Mesh Pillar. For TT105G & TT126G Includes linch pins.

Hydraulic Spares for the SPX Fenner & Fluidlink Pumps



SPARES FOR FENNER/SPX HYDRAULIC POWER PACK

- 1 P11972 **Controller.** Hand controller and weatherproof plug.
- 2 P119714 **Solenoid.** For the Fenner/SPX Hydraulic power units.
- 3 P119722 **Pump Handle.** For the manual pump section.
- 4 P119715 **Release Solenoid.** For the release valve.
- 5 P1244 **End Plug.** Round blanking plug.
- 6 P119724 **Manual Release Screw.** Including seal.
- 7 P119716 **Hand Pump Cartridge.** For the manual pump section.
- 8 P119713 **Filler Cap.** Incorporating breather.
- 9 P0670 **Isolator Switch.** Battery isolator switch supplied with one removable key.
- 10 P07255 **Aqua Safe Plug and Socket.** Waterproof plug and socket used for the interior lamp connector on DP trailers and the handset connection on tippers.
- 11 P0670A **Isolator Key.** Spare key for isolator switch.
- P119712 **Tank.** Plastic Reservoir for the Fenner/SPX Hydraulic.
- P119710 **Motor.** Replacement motor.
- P119720 **Release Valve Cartridge.**

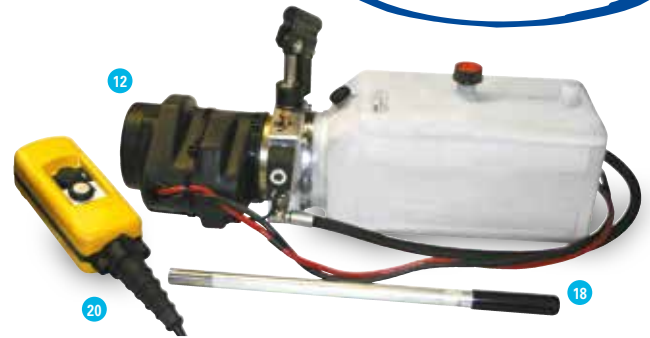

SPARES FOR THE FLUIDLINK POWER PACK



Fitted to the TT85G since 10/12/2006 and to the TT105G & TT126G since 19-03-2007

- 12 P11974 **Hydraulic Power Pack.** FG525 12v.
- 13 P11974BC **Battery Cables.**
- 14 P11974DD **Drive Dog.**
- 15 P11974EP **3-Pin Handset Plug.**
- 16 P11974ES **3-Pin Handset Socket.**
- 17 P11974FC **Filler Cap.**
- 18 P11974H **Pump Handle.**
- 19 P11974HH **Hydraulic Hose.**
- 20 P11974HS **Handset and Lead.**
- P119745LC **Coil for Lowering Valve.** For model FG525, not compatible with FG515 alone please change valve complete.
- 21 P119745LV **Lowering Valve Complete.** Compatible with FG515 & FG525 models.
- P119745LVNC **Lowering Valve (no coil).** For model FG525, not compatible with FG515 alone please change valve complete.
- 22 P11974M **Motor.**
- 23 P11974MC **Motor Cover.**
- 24 P11974P **Pump Kit.**
- 25 P11974SC **Seal kit (O Rings).**
- 26 P11974SS **Start Solenoid.** Compatible with FG525 & FG515 (when copper strip fitted)
- 27 P11974T **Tank Kit.**





ACCESSORIES

	AS0587	Ladder Rack.
	KX0602	Mesh Side Kit.
1	KS0204	Lashing Lugs. One pair of lashing lugs, backing plates and fittings.
2	KX0201	Recessed lashing Ring Kit. One lashing ring and backing plate & fittings.
	KX5100	Knife Edge Kit. Bolt on addition for the ramp.

CHASSIS & BODY PARTS

	AS0550	Drawbar.
3	C10625	Front Drawbar Attachment Bracket. Right hand.
	C10626	Front Drawbar Attachment Bracket. Left hand.
	AS0970	Suspension Cross Member Set.
	C10550	Side Panel. Right hand.
	C10551	Side Panel. Left hand.
	C10554	Front Panel.
4	C10560	Front Corner Bracket.
5	C10567	Front Corner Bracket.
6	C20550	Front Corner Socket.
7	C10635	Side Brace Fixing Bracket. Right hand.
	C10636	Side Brace Fixing Bracket. Left hand.
8	C10762	Rear Light Bracket. Right hand.
	C10763	Rear Light Bracket. Left hand.
9	C10559	Rear Cross Member.
10	C10614	Rear Cross Member Brace. Right hand.
	C10615	Rear Cross Member Brace. Left hand.
11	C10622	Load Lashing Bracket.
	C04667	Rope Hook.





MUDGUARDS

	C10555	Mudguard. Right hand.
	C10556	Mudguard. Left hand.
12	C10557	Mudguard Cone. Right hand.
	C10558	Mudguard Cone. Left hand.
13	C10564	Mudguard Joining Plate.
14	C10565	Mudguard Side Jointing Plate.
15	C12980	Spray Guard. Right hand.
	C12981	Spray Guard. Left hand.
16	C72614	Rainflap.
17	P1385	Anti-Slip Cleat.

BUCKET REST







18	C10355	Bucket Rest Platform.
	C10360	Bucket Rest Support. Right hand.
	C10361	Bucket Rest Support. Left hand.

RAMP & SKID INSTALLATION

	KS5150	Standard Ramp Kit. Includes adjustable legs, corner pillars, hinges, gas strut and brackets, and ramp fasteners.
	KS5150/6	6' Ramp Kit. Includes adjustable legs, corner pillars, ramp stays, hinges, gas strut and brackets, and ramp fasteners.
	KS5110	Skid Installation Kit. Includes corner pillars, hinges and ramp fasteners.
	KS5110/6	Skid Installation Kit 6'. Includes corner pillars, hinges and ramp fasteners.
19	AS0096	Adjustable Leg. Compatible with the ramp kit.
20	AS0558	Ramp Hinge Tube. Compatible with the ramp kit.
	AS0568	Ramp Hinge Pivot Bracket. Right hand. Compatible with the ramp and skid kits.
21	AS0569	Ramp Hinge Pivot Bracket. Left hand. Compatible with the ramp and skid kits.
22	AS0623	Ramp Hinge Bracket. Compatible with the skid kit.
	C29418-01725	Hinge Rod. Compatible with the skid kits.
23	AS0598	Gas Strut Bracket. Top, compatible with the ramp kit.
24	C10640	Gas Strut Bracket. Bottom, compatible with the ramp kit.
25	C10707	Rear Corner Pillar. Compatible with the ramp and skid kits.
26	C30709	Ramp Fastener Handle. M14. Left hand. Compatible with the ramp and skid kits.
27	P10885	Ramp Fastener Eye Bolt. M14. Left hand. Compatible with the ramp and skid kits.
28	P1191	Gas Spring. Compatible with the ramp kit.



ACCESSORIES

	AS0589	Ladder Rack.	
	KX0607	Mesh Side Kit. GX85.	
	KX0605	Mesh Side Kit. GX105.	
	KS0204	Lashing Lugs. One pair of lashing lugs, backing plates and fittings.	
	KX0201	Recessed lashing Ring Kit. One lashing ring and backing plate & fittings.	
	KX5105	Knife Edge Kit. Bolt on addition for the ramp.	

CHASSIS & BODY PARTS

	AS0540	Drawbar. GX85.	
	AS0570	Drawbar. GX105.	
	AS0608	Cross Member Weld Assembly. GX105.	
	C10950	Front Drawbar Attachment Bracket. Right hand.	
	C10951	Front Drawbar Attachment Bracket. Left hand.	
	AS0974	Suspension Cross Member Set. GX85.	
	AS0975	Suspension Cross Member Set. GX105.	
	C10550	Side Panel. Right hand, GX85.	
	C10580	Side Panel. Right hand, GX105.	
	C10551	Side Panel. Left hand, GX85.	
	C10581	Side Panel. Left hand, GX105.	
	C10945	Front Panel.	
	C10560	Front Corner Bracket.	
	C10567	Front Corner Bracket.	
	C20550	Front Corner Socket.	
	C10635	Side Brace Fixing Bracket. Right hand.	
	C10636	Side Brace Fixing Bracket. Left hand.	
	C10762	Rear Light Bracket. Right hand.	
	C10763	Rear Light Bracket. Left hand.	
	C10946	Rear Cross Member.	
	C10614	Rear Cross Member Brace. Right hand.	
	C10615	Rear Cross Member Brace. Left hand.	
	C10622	Load Lashing Bracket.	
	C04667	Rope Hook.	

BUCKET REST

	C10952	Bucket Rest Platform.	
	C10953	Bucket Rest Support. Right hand.	
	C10954	Bucket Rest Support. Left hand.	

MUDGUARDS

C10555	Mudguard. Right hand. GX85.
C10976	Mudguard. Right hand. GX105.
C10556	Mudguard. Left hand. GX85.
C10977	Mudguard. Left hand. GX105.
C10557	Mudguard Cone. Right hand.
C10558	Mudguard Cone. Left hand.
C10564	Mudguard Joining Plate.
C10565	Mudguard Side Jointing Plate.
C12980	Spray Guard. Right hand.
C12981	Spray Guard. Left hand.
C72614	Rainflap.
P1385	Anti-Slip Cleat.



RAMP & SKID INSTALLATION

KS5160	Standard Ramp Kit. Includes adjustable legs, corner pillars, hinges, gas strut and brackets, and ramp fasteners. GX85, GX105.
KS5160/6	6' Ramp Kit. Includes adjustable legs, corner pillars, ramp stays, hinges, gas strut and brackets, and ramp fasteners. GX85, GX105.
KS5116	Skid Installation Kit. Includes corner pillars, hinges and ramp fasteners. GX85, GX105.
KS5117	Skid Installation Kit. Includes corner pillars, hinges and ramp fasteners. GX105HD.
KS5116/6	Skid Installation Kit 6'. Includes corner pillars, hinges and ramp fasteners. GX85, GX105.
KS5117/6	Skid Installation Kit 6'. Includes corner pillars, hinges and ramp fasteners. GX105HD.
AS0096	Adjustable Leg. Compatible with the ramp kits.
AS0558	Ramp Hinge Tube. Compatible with the ramp kit.
AS0568	Ramp Hinge Pivot Bracket. Right hand. Compatible with the ramp and skid kits.
AS0569	Ramp Hinge Pivot Bracket. Left hand. Compatible with the ramp and skid kits.
AS0623	Ramp Hinge Bracket. Compatible with the skid kit.
C29418-02050	Hinge Rod. Compatible with the skid kits.
AS0598	Gas Strut Bracket. Top, compatible with the ramp kit
C10640	Gas Strut Bracket. Bottom, compatible with the ramp kit.
C10707	Rear Corner Pillar. Compatible with the ramp and skid kits.
C30709	Ramp Fastener Handle. M14. Left hand. Compatible with the ramp and skid kits.
P10885	Ramp Fastener Eye Bolt. M14. Left hand. Compatible with the ramp and skid kits.
P1191	Gas Spring. Compatible with the ramp kit.



GX106 with skids and integrated rear supports

ACCESSORIES

	AS0591	Ladder Rack.
	KX0603	Mesh Side Kit.
	KS0204	Lashing Lugs. One pair of lashing lugs, backing plates and fittings.
	KX0201	Recessed lashing Ring Kit. One lashing ring and backing plate & fittings.
	KX5115	Knife Edge Kit. Bolt on addition for the ramp.

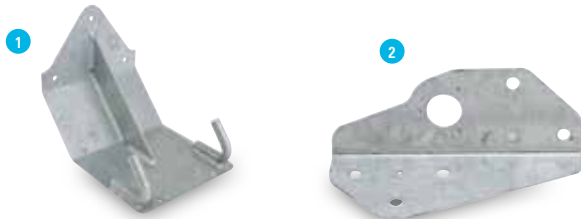

CHASSIS & BODY PARTS

	AS0570	Drawbar.
1	AS0573	Side Reinforcing Bracket.
	AS0571	Cross Member Weld Assembly. 2 per trailer.
2	C10625	Front Drawbar Attachment Bracket. Right hand.
	C10626	Front Drawbar Attachment Bracket. Left hand.
	AS0980	Suspension Cross Member Set.
	C10580	Side Panel. Right hand.
	C10581	Side Panel. Left hand.
	C10585	Front Panel.
	C10560	Front Corner Bracket.
	C10567	Front Corner Bracket.
	C20550	Front Corner Socket.
	C10635	Side Brace Fixing Bracket. Right hand.
	C10636	Side Brace Fixing Bracket. Left hand.
	C10764	Rear Light Bracket. Right hand.
	C10765	Rear Light Bracket. Left hand.
	C10602	Rear Cross Member.
	C10614	Rear Cross Member Brace. Right hand.
	C10615	Rear Cross Member Brace. Left hand.
	C10622	Load Lashing Bracket.
	C04667	Rope Hook.

BUCKET REST

C10359	Bucket Rest Platform.
C10627	Bucket Rest Support. Right hand.
C10628	Bucket Rest Support. Left hand.

MUDGUARDS

C10565	Mudguard. Side Jointing Plate.
C10586	Mudguard. Right hand.
C10587	Mudguard. Left hand.
C10588	Mudguard Cone. Right hand.
C10589	Mudguard Cone. Left hand.
C10601	Mudguard. Joining Plate.
C12982	Spray Guard. Right hand.
C12983	Spray Guard. Left hand.
C72615	Rainflap.
P1385	Anti-Slip Cleat.





RAMP & SKID INSTALLATION

KS5180	Standard Ramp Kit. Includes adjustable legs, corner pillars, hinges, gas strut and brackets, and ramp fasteners.
KS5180/6	6' Ramp Kit. Includes adjustable legs, corner pillars, ramp stays, hinges, gas strut and brackets, and ramp fasteners.
KS5110	Skid Installation Kit. Includes corner pillars, hinges and ramp fasteners.
KS5110/6	Skid Installation Kit 6'. Includes corner pillars, hinges and ramp fasteners.
AS0096	Adjustable Leg. Compatible with the ramp kits.
AS0558	Ramp Hinge Tube. Compatible with the ramp kit.
AS0579	Ramp Hinge Pivot Bracket. Right hand. Compatible with the ramp and skid kits.
AS0580	Ramp Hinge Pivot Bracket. Left hand. Compatible with the ramp and skid kits.
AS0623	Ramp Hinge Bracket. Compatible with the skid kit.
C29418-02250	Hinge Rod. Compatible with the skid kits.
AS0598	Gas Strut Bracket. Top, compatible with the ramp kit.
C10640	Gas Strut Bracket. Bottom, compatible with the ramp kit.
C10707	Rear Corner Pillar. Compatible with the ramp and skid kits.
C30709	Ramp Fastener Handle. M14. Left hand. Compatible with the ramp and skid kits.
P10885	Ramp Fastener Eye Bolt. M14. Left hand. Compatible with the ramp and skid kits.
P1191	Gas Spring. Compatible with the ramp kit.















GX126 tri axle with ramp

ACCESSORIES

	AS0589	Ladder Rack. GX125HD.
	AS0591	Ladder Rack. GX126.
	KX0608	Mesh Side Kit. GX125HD
	KX0606	Mesh Side Kit. GX126.
	KS0204	Lashing Lugs. One pair of lashing lugs, backing plates and fittings.
	KX0201	Recessed lashing Ring Kit. One lashing ring and backing plate & fittings.
	KX5115	Knife Edge Kit. Bolt on addition for the ramp.

CHASSIS & BODY PARTS

	AS0570	Drawbar.
	C10950	Front Drawbar Attachment Bracket. Right hand. GX125HD.
	C10625	Front Drawbar Attachment Bracket. Right hand. GX126.
	C10951	Front Drawbar Attachment Bracket. Left hand. GX125HD.
	C10626	Front Drawbar Attachment Bracket. Left hand. GX106.
	AS0608	Cross Member Weld Assenbly. GX125HD.
	AS0571	Cross Member Weld Assenbly. GX126.
	AS0573	Side Reinforcing Bracket. GX126.
	AS0609	Drawbar Attachment Cross Member. GX126. 
	AS0622	Side Reinforcing Bracket. GX125HD. 
	AS0609	Drawbar Attachment Cross Member. GX126. 
	AS0660	Drawbar Attachment Cross Member. GX126 Tri. 
	AS0661	Drawbar Attachment Cross Member. GX125HD. 
	AS0895	Suspension Cross Member Set. GX125HD .
	AS0905	Suspension Cross Member Set. GX126 .
	AS0900	Suspension Cross Member Set. GX126 Tri .
	C10985	Side Panel. Right hand. GX125HD & GX126 .
	C10960	Side Panel. Right hand. GX126 Tri .
	C10986	Side Panel. Left hand. GX125HD & GX126 .
	C10961	Side Panel. Left hand. GX126 Tri .
	C10945	Front Panel. GX125HD.
	C10585	Front Panel. GX126.
	C10560	Front Corner Bracket.
	C10567	Front Corner Bracket.
	C20550	Front Corner Socket.
	C10635	Side Brace Fixing Bracket. Right hand.

C10636	Side Brace Fixing Bracket. Left hand.
C10762	Rear Light Bracket. Right hand. GX125HD.
C10764	Rear Light Bracket. Right hand. GX126.
C10763	Rear Light Bracket. Left hand. GX125HD.
C10765	Rear Light Bracket. Left hand. GX126.
C10946	Rear Cross Member. GX125HD.
C10602	Rear Cross Member. GX126.
C10614	Rear Cross Member Brace. Right hand.
C10615	Rear Cross Member Brace. Left hand.
C10990	Rear Cross Member Brace. 1 per trailer. GX126
C10963	Rear Cross Member Brace. 1 per trailer. GX126 Tri.
C10622	Load Lashing Bracket.
C04667	Rope Hook.

MUDGUARDS









C10564	Mudguard Jointing Plate. GX125HD.
C10601	Mudguard Jointing Plate. GX126.
C10565	Mudguard Side Jointing Plate.
C10982	Mudguard. Right hand. GX125HD.
C10987	Mudguard. Right hand. GX126.
C10996	Mudguard. Right hand. GX126 Tri.
C10983	Mudguard. Left hand. GX125HD.
C10988	Mudguard. Left hand. GX126.
C10997	Mudguard. Left hand. GX126 Tri.
C10557	Mudguard Cone. Right hand. GX125HD.
C10588	Mudguard Cone. Right hand. GX126.
C10558	Mudguard Cone. Left hand. GX125HD.
C10589	Mudguard Cone. Left hand. GX126.
C12980	Spray Guard. Right hand. GX125HD.
C12982	Spray Guard. Right hand. GX126.
C12981	Spray Guard. Left hand. GX125HD.
C12983	Spray Guard. Left hand. GX126.
C72614	Rainflap. GX125HD.
C72615	Rainflap. GX126.
P1385	Anti-Slip Cleat.



BUCKET REST

C10952	Bucket Rest Platform. GX125HD.
C10359	Bucket Rest Platform. GX126.
C10953	Bucket Rest Support. Right hand. GX125HD.
C10627	Bucket Rest Support. Right hand. GX126.
C10954	Bucket Rest Support. Left hand. GX125HD.
C10628	Bucket Rest Support. Left hand. GX126.







RAMP & SKID INSTALLATION

	KS5160	Standard Ramp Kit. Includes adjustable legs, corner pillars, hinges, gas strut and brackets, and ramp fasteners. GX125HD.
	KS5180	Standard Ramp Kit. Includes adjustable legs, corner pillars, hinges, gas strut and brackets, and ramp fasteners. GX126.
	KS5160/6	6' Ramp Kit. Includes adjustable legs, corner pillars, ramp stays, hinges, gas strut and brackets, and ramp fasteners. GX125HD.
	KS5180/6	6' Ramp Kit. Includes adjustable legs, corner pillars, ramp stays, hinges, gas strut and brackets, and ramp fasteners. GX126.
	KS5117	Skid Installation Kit. Includes corner pillars, hinges and ramp fasteners. GX125HD.
	KS5130	Skid Installation Kit. Includes corner pillars, hinges and ramp fasteners. GX126.
	KS5117/6	Skid Installation Kit 6'. Includes corner pillars, hinges and ramp fasteners. GX125HD.
	KS5130/6	Skid Installation Kit 6'. Includes corner pillars, hinges and ramp fasteners. GX126.
	AS0096	Adjustable Leg. Compatible with the ramp kits.
	AS0558	Ramp Hinge Tube. Compatible with the ramp kit.
	AS0568	Ramp Hinge Pivot Bracket. Right hand. Compatible with the ramp and skid kits. GX125HD.
	AS0579	Ramp Hinge Pivot Bracket. Right hand. Compatible with the ramp and skid kits. GX126.

AS0569	Ramp Hinge Pivot Bracket. Left hand. Compatible with the ramp and skid kits. GX125HD.
AS0580	Ramp Hinge Pivot Bracket. Left hand. Compatible with the ramp and skid kits. GX126.
AS0623	Ramp Hinge Bracket. Compatible with the skid kit.
C29418-02050	Hinge Rod. Compatible with the skid kits. GX125HD.
C29418-02250	Hinge Rod. Compatible with the skid kits. GX126.
AS0598	Gas Strut Bracket. Top, compatible with the ramp kit.
C10640	Gas Strut Bracket. Bottom, compatible with the ramp kit.
C10707	Rear Corner Pillar. Compatible with the ramp and skid kits.
C30709	Ramp Fastener Handle. M14. Left hand. Compatible with the ramp and skid kits.
P10885	Ramp Fastener Eye Bolt. M14. Left hand. Compatible with the ramp and skid kits.
P1191	Gas Spring. Compatible with the ramp kit.







ALUMINIUM MUDGUARDS & FITTINGS

**GP106, GP106H,
GP126, GP126H,
GP146 & GP146H**

-  **C40079** **Aluminium Mudguard.** Compatible with the GP1*6GM with 6.50 R16 wheels fitted.
-  **C40083** **Aluminium Mudguard.** Compatible with the GP1*6GM & GP127GM with 175/75 R16 wheels fitted.
-  **C40087** **Aluminium Mudguard.** Compatible with the GP1*6GM with 155/70R12 & 195/60 R12 & GP127GM with 185 60 R12 wheels fitted.
-  **C40082** **Aluminium Mudguard.** Compatible with the GP1*6GM Tri axle & GP147GM Tri axle with 175/75R16 wheels fitted.
-  **C40085** **Aluminium Mudguard.** Compatible with the GP1*6GM Tri axle & GP147GM Tri axle with 155/70R12 & 195/60 R12 wheels fitted.
-  **C40152** **Aluminium Mudguard.** Low, compatible with the GP146GM & GP147GM with 195 60 R12 wheels fitted.
-  **C40154** **Aluminium Mudguard.** Low, compatible with the GP146GM & GP147GM with 175 75 R16 wheels fitted.
- 1** **C12986** **Spray Guard.** Right hand, compatible with 12" wheels.
- C12987** **Spray Guard.** Left hand, compatible with 12" wheels.
- C12988** **Spray Guard.** Right hand, compatible with 175 wheels.
- C12989** **Spray Guard.** Left hand, compatible with 175 wheels.
- 2** **C42477** **Mudguard Corner Gussett.**
- C20427-00015** **Mudguard Bracket Spacer.**







LOADING SKIDS & FULL WIDTH RAMPS



-  **KS5135** **Loading Skid Kit.** For trailers with 155 70 R12 Wheels fitted. All fittings included.
-  **KS5135/6** **Loading Skid Kit.** 6' high for trailers with 155 70 R12 Wheels fitted. All fittings included.
-  **KS5140** **Loading Skid Kit.** For trailers with 175 75 R16 Wheels fitted. All fittings included.
-  **KS5140/6** **Loading Skid Kit.** 6' high for trailers with 175 75 R16 Wheels fitted. All fittings included.
-  **KS5185** **Full Width Ramp.** 4' high complete with all fittings.
-  **KS5185/6** **Full Width Ramp.** 6' high complete with all fittings.
- 3** **AS0623** **Hinge Bracket.** One per trailer, compatible with the skids.
- C29418-01970** **Hinge Bar.** Compatible with the skids.
- C40300** **Number Plate Mounting Panel.** Compatible with the skids.
- 4** **AS0702** **Ramp Hinge Bracket.** Right hand. Compatible with the ramp & skids.
- AS0703** **Ramp Hinge Bracket.** Left hand. Compatible with the ramp & skids.
- C30709** **Ramp Fastener Handle.** M14. Compatible with the ramp & skids.
- P10885** **Ramp Fastener Eye Bolt.** M14. Compatible with the ramp & skids.
- C20937** **Ramp Hinge Tube.** Compatible with the ramp.
- P1246** **Hinge Pivot Bush.** Compatible with the ramp.
- AS0096** **Adjustable Leg.** 3 per ramp, compatible with the full width ramp.
- AS0598** **Gas Strut Bracket.** Lower. Compatible with the ramp.
- C10640** **Gas Strut Bracket.** Upper. Compatible with the ramp.
- P1191** **Gas Spring.** Compatible with the ramp.
- P1192** **Protective Bellows.** Compatible with the ramp.
- C40304** **Number Plate Mounting Panel.** Compatible with the ramp.
- C20123** **Ramp Stay.** Compatible with the 6' ramp.

ACCESSORIES

Available on the Low sided models only.

-  **KX1620** **Filled in Side Kit.** GP106 Available for the low sided models only. Includes 6 lashing rings.
-  **KX1625** **Filled in Side Kit.** GP126 Available for the low sided models only. Includes 6 lashing rings.
-  **KX1630** **Filled in Side Kit.** GP146 Available for the low sided models only. Includes 6 lashing rings.
-  **KX1685** **Ladder Rack Kit.** Suitable for the GP106H, GP126H & GP146H.
- KX1680** **Bucket Rest Kit.** Suitable for the GP106H, GP126H & GP146H.







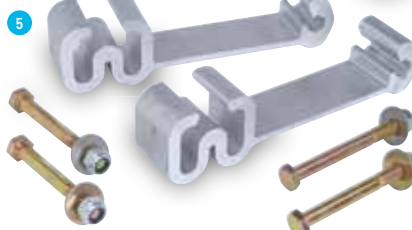
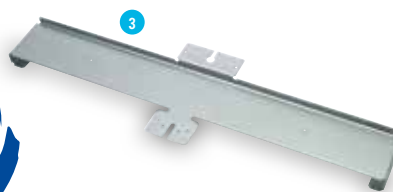

MESH SIDE KITS (HIGH SIDED MODELS ONLY)

-  **KX1690** **Mesh Side kit.** GP106H includes mesh ladder rack, right and left hand side mesh panels.
-  **KX1691** **Mesh Side Kit.** GP126H includes mesh ladder rack, right and left hand side mesh panels.





GH64, GH94, GH94BT & GH1054



RAMP & SKID KITS







	AS2591	1.2m Mesh Ramp. GH64.
	AS2602	1.5m Bevelled Ramp. GH64.
	KS26501	1.2m Full Width Ramp. GH94 & GH94BT. Introduced mid-2016, compatible with older models.
	AS2630	1.5m Bevelled Ramp. GH94 & GH94BT.
	KS26505	1.2m Full Width Ramp. GH1054. Introduced mid-2016, compatible with older models.
	AS2636	1.5m Bevelled Ramp. GH1054.
	KS2646	1.5m Sliding Skids. GH94 & GH94BT.
	KS2647	1.5m Sliding Skids. GH1054.

RAMP & SKID SPARES

	AS2657	Ramp Helper Arm. Fitted to GH94, GH94BT & GH1054 trailers equipped with 1.2m Full Width Ramp.
	AS2597	Ramp Helper Arm. Fitted to the GH64 (all ramp variants) GH94, GH94BT & GH1054 (trailers equipped with current 1.5m Bevelled Ramp and 1.5m Sliding Skids). Was also fitted to GH94, GH94BT & GH1054 trailers with 1.2m Mesh Ramps.
	C20941Z	Ramp Hinge Tube Case / Spindle. Fitted to the GH64 (all ramp variants) GH94, GH94BT & GH1054 (trailers equipped with current 1.5m Bevelled Ramp and 1.5m Sliding Skids). Was also fitted to GH94, GH94BT & GH1054 trailers with 1.2m Mesh Ramps.
	C20942Z	Ramp Hinge Tube Case / Spindle. Fitted to GH94, GH94BT & GH1054 trailers equipped with 1.2m Full Width Ramp.
	C12525	Number Plate Backing. Compatible with the GH64 ramp.
	C13212	Clip in Number Plate Holder. Compatible with the current 1.2m Full Width ramp on the GH94 & GH94BT.
	C13214	Clip in Number Plate Holder. Compatible with the current 1.2m Full Width ramp on the GH1054.
	C12472	Number Plate Backing. GH94 & GH94BT 1.5m Bevelled Ramp.
	C12569	Number Plate Backing. GH1054BT Bevelled Ramp.
	P1159-00470	Ramp Spring. GH64 ramp.
	P1163	Ramp Spring. GH94 & GH94BT.
	P1159	Ramp Spring. GH1054BT.
	C30709	Ramp Fastener. M14, used on the ramp & skid options.
	P10885	Eye Bolt. M14, used on the ramp & skid options.
	AS2646	Skid Centre Support.
	C29418-01350	Sliding Skid Support Bar. GH94 & GH94BT.
	C29418-01666	Sliding Skid Support Bar. GH1054BT.
	C14205	Reverse/Fog Mounting Plate. Compatible with the sliding skids.
	C14217	Number Plate Mounting Plate. Compatible with the sliding skids.



ACCESSORIES

	KX35327	48mm Coupling Raiser Kit. This kit includes 2 aluminium raisers, nuts & bolts. Fitted as standard to the GH64 & GH94, available as an option on the GH94BT & GH1054BT.
	KX35314	80mm Coupling Raiser Kit. This kit includes 2 aluminium raisers nuts & bolts. Available as an option on all the GH range.
	KX35318	Spare Wheel Kit. Compatible with the GH94BT. The kit includes 1 x 165R13C wheel assembly, mounting plate, securing strap, U bolts and fittings.
	KX35319	Spare Wheel Kit. Compatible with the GH94. The kit includes 1 x 195/55R10 wheel assembly, mounting plate, securing strap, U bolts and fittings.
	KX35320	Spare Wheel Kit. Compatible with the GH1054. The kit includes 1 x 185/70R13 wheel assembly, mounting plate, securing strap, U bolts and fittings.
	KS3740	Bolt on Lashing Lug Kit. One pair of lashing lugs, socket screws and nuts.
	KX35335	GH Toolbox Kit. Compatible with the GH94BT & GH1054. A heavy duty, lockable, steel toolbox allows three sets of ratchet straps and tools to be locked away securely. (Padlock not included)

DEDICATED SPARES

	C72583	Rainflap. GH64.
	C72584	Rainflap. GH94BT & GH1054.
	C72588	Rainflap. GH94.
	C72589	Intermediate Rainflap. GH94.



DRAWBAR & COUPLING

AS3705	Drawbar Weld Assembly.
1 C01700	Drawbar Pivot Bush.
2 C01705	Drawbar Pivot Bolt.
3 C11722	Drawbar Pivot Bracket. Right hand.
C11723	Drawbar Pivot Bracket. Left hand.
4 AS3711	Centre Shackle. Right hand.
AS3712	Centre Shackle. Left hand.
5 C01706	Extended Jockey Wheel Clamp Handle.
6 P1087	Body Clamp. Over centre clamp that secures the body to the drawbar.
7 AS3713	Hook & Base Plate. Receiver for the body clamp.



LOADING SKIDS AND LIGHT BRACKETS

8 AS3729	Skid Assembly. Compatible with the CT177 mk2. Non handed, sold individually.
AS3736	Fold Out Adjustable Rear Light Mounting Bracket. Left hand, for use with Rubolite lamps. Compatible with the CT177 mk2 Fitted since March 2008.
9 AS3737	Fold Out Adjustable Rear Light Mounting Bracket. Right hand, for use with Rubolite lamps. Compatible with the CT177 mk2 Fitted since March 2008.
10 KS3715	Fold Out Adjustable Rear Light Mounting Bracket. Right hand, for use with Aspock lamps. Fitted till March 2008.
KS3716	Fold Out Adjustable Rear Light Mounting Bracket. Left hand, for use with Aspock lamps. Fitted till March 2008.
11 C01703	Light Bracket Pivot Bar.
12 P1096	Linch Pin. Secures the rear light bracket.
13 C11717	Side Marker Lamp Mounting Bracket.
14 C11746	Number Plate Mount.
15 C11924	Fog Lamp Bracket. Side pod mounted.

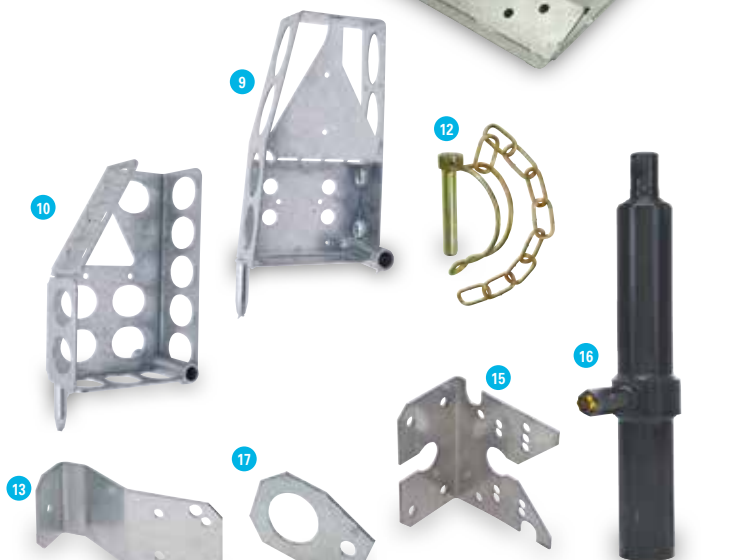

HYDRAULICS

16 P11317	Hydraulic Ram.
17 C11732	Ram Retaining Plate.
18 P11415	Hydraulic Manual Pump.
19 P11415H	Manual Pump Handle.



WINCH MOUNTING

20 AS3732	Winch Mount. Allows the winch to be moved from side to side, allowing for variation in vehicle towing eye position.
21 C21751	Winch Guide Tube.

BODY COMPONENTS

22 C11878	Inner Mudguard. Left hand.
C11879	Inner Mudguard. Right hand.
23 C72614	Rainflap.
24 P1385	Anti Slip Cleats.
C11736	Tool Box Lid.
P1086	Over Centre Clasp. For securing the tool box lid.



CT136 Twin axle model

ACCESSORIES & OPTIONS

P04705	Winch "Circuit". 600lb rated mechanical cable winch.	
P04706	Winch "Rally". 1050lb rated mechanical cable winch.	
P04707	Winch "Recovery". 1500lb rated mechanical cable winch.	
1 KX5528	Winch Mounting Kit. CT136 & CT136HD Required to fit the winch options above. Mounting bar and winch mounting bracket allows winch to be fitted in the left or right hand mounting positions.	
KX5525	Winch Mounting Kit. CT115. Required to fit the winch options above. Mounting bar and winch mounting bracket allows winch to be fitted in the left or right hand mounting positions.	
2 KX5536	Aluminium Treadplate Infill Kit. CT136, CT136HD. Provides a safe walk on platform as an alternative to the open centre. The kit includes a front and rear deck infill and all fittings.	
3 K55334	Tyre Rack Cranked Bar. CT136, CT136HD Mounted to the front of this trailer this adjustable rack can accommodate a set of differently sized wheels/tyres. Maximum difference in tyre diameters of 65mm.	
KX5535	Tyre Rack Straight Bar. CT136, CT136HD. Mounted to the front of the trailer this adjustable rack can accommodate a set of wheels/tyres ranging from 500mm to 650mm in diameter.	
KX5522	Tyre Rack Cranked Bar. CT115. Mounted to the front of this trailer this adjustable rack can accommodate a set of differently sized wheels/tyres. Maximum difference in tyre diameters of 65mm.	
KX5523	Tyre Rack Straight Bar. CT115. Mounted to the front of the trailer this adjustable rack can accommodate a set of wheels/tyres ranging from 500mm to 650mm in diameter.	
P1042	Heavy Duty Wheel Securing Straps. Incorporating soft link to avoid damage to alloy wheels.	
4 KX0242	Wheel Chocks. CT136 / CT115. Slide - in front wheel chocks. One pair including fasteners. For vehicles with low ground clearance this feature is invaluable. The wheel stop can be fitted between the wheel and the spoiler after the vehicle is loaded.	
KX0243	Spare Wheel Kit. For all models of CT136 & CT115. The kit includes wheel and tyre, mounting bracket, wheel brace and all fittings.	
5 KX0235	Toolbox Kit. CT136, CT115 Heavy duty, lockable, steel toolbox allows wheel straps and tools to be locked away securely.	





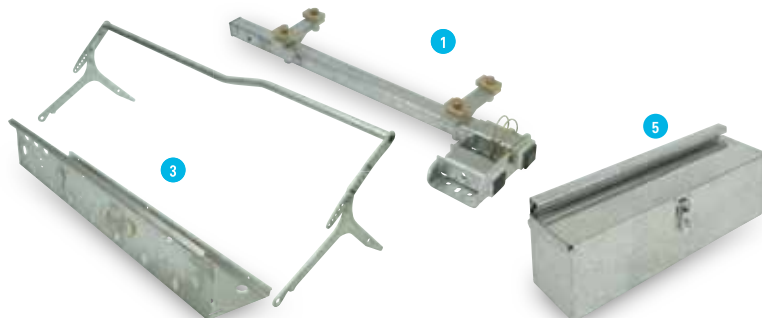

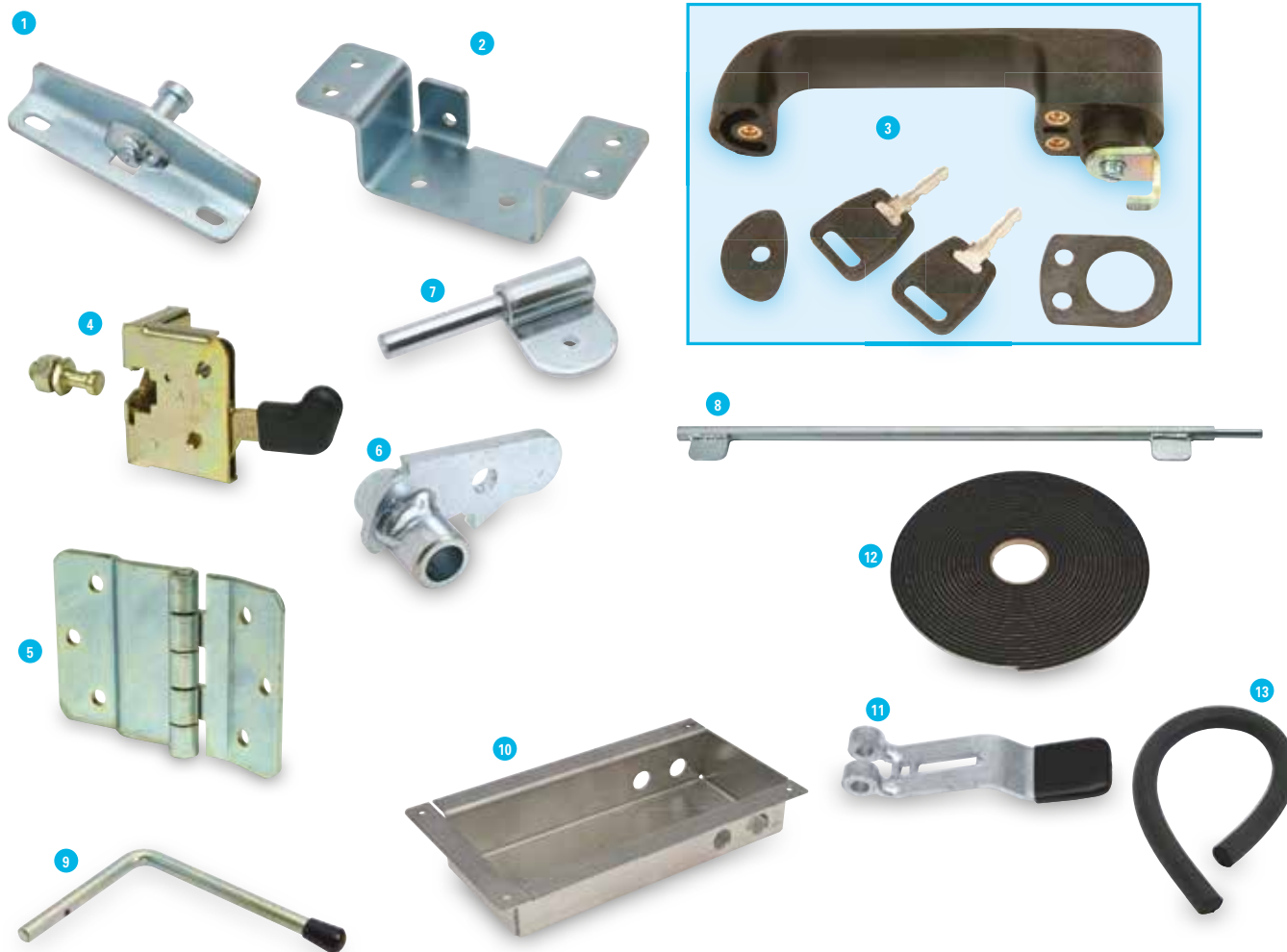











UNIQUE SPARE PARTS

KS0251	Drawbar Assembly.
AS0892	Suspension Cross Member Set. CT115.
AS1821	Suspension Cross Member Set. CT136SA.
AS1810	Suspension Cross Member Set. CT136, CT136HD.
AS1816	Steady Leg Inner Assembly.
C11828	Rear Light Bracket. Right hand. Also acts as the cross member support. Compatible with Aspock and Rubolite lamps.
C11814	Rear Light Bracket. Left hand. Also acts as the cross member support. Compatible with Aspock and Rubolite lamps.
C11883	Number Plate Bracket. CT115, fold down number plate / skid flap.
C11845	Number Plate Bracket. CT136, fold down number plate / skid flap.
C11864	Number Plate Bracket. CT136HD, fold down number plate / skid flap.
6 C11924	Fog Lamp Bracket. Side pod mounted.
C11852	Loading Skid. CT115 & CT136. Right hand when deployed, left hand when stowed.
C11826	Loading Skid. CT115 & CT136. Left hand when deployed, right hand when stowed.
AS1886	Loading Skid. CT136HD. Right hand when deployed, left hand when stowed.
AS1887	Loading Skid. CT136HD Left hand when deployed, right hand when stowed.
7 C74810	Skid Stop. Plastic stop fitted to the end of the skid pressings and trailer beds.
WT5100-00040	Aluminium Coupling Raiser. 40mm.





BODY & ROOF PANELS

-  **C69617** GRP White Panel. BV84G & BV85G Side panel 1525mm x 2431 x 14mm.
-  **C69601** GRP White Panel. BV105G & BV106G Side panel 1829mm x 3041mm x 14mm
-  **C69614** GRP White Panel. BV125G & BV126G Side panel 1829mm x 3658mm x 14mm. Please specify model when placing order.
-  **C69609** GRP White Panel. BV106G 7' headroom Side panel 2134mm x 3041mm x 14mm.
-  **C69610** GRP White Panel. BV126G 7' headroom Side panel 2134mm x 3658mm x 14mm.
-  **C69618** GRP White Panel. BV84G Front right hand panel 690mm x 1520mm x 14mm.
-  **C69602** GRP White Panel. BV*5G 5' & 6' headroom Front right hand panel 1824mm x 870 x 14mm. Please specify headroom when placing order.
-  **C69611** GRP White Panel. BV*5G & BV*6 7' Front right hand panel 2129mm x 1010mm x 14mm.
-  **C69615** GRP White Panel. BV*6G 6' Front right hand panel 1824mm x 1010mm x 14mm.
-  **C69619** GRP White Panel. BV84 inspection door panel. 540mm x 1368mm x 14mm.
-  **C69603** GRP White Panel. BV*5G 5' & 6' headroom inspection door panel. 1673mm x 716mm x 14mm. Please specify headroom when placing order.
-  **C69612** GRP White Panel. BV*5G 7' & BV*6 7' inspection door panel. 1978mm x 863mm x 14mm.
-  **C69616** GRP White Panel. BV*6G 6' inspection door panel. 1678mm x 863mm x 14mm.
-  **C79305** Opal GRP Roof Sheet. BV84G.
-  **C79306** Opal GRP Roof Sheet. BV85G.
-  **C79307** Opal GRP Roof Sheet. BV105G.
-  **C79308** Opal GRP Roof Sheet. BV125G, BV106G, BV126G – (cut to correct size upon order).
-  **P1377** Tape. 2mm x 12mm x 50m roll. Used for sealing the roof sheet.

INSPECTION DOOR FITTINGS

- AS0441** Inspection Door Outer Frame. BV84G.
- AS0448** Inspection Door Outer Frame. BV85G 5' head room.
- AS0442** Inspection Door Outer Frame. BV*5G 6' head room.
- AS0444** Inspection Door Outer Frame. BV*5G 7' head room.
- AS0449** Inspection Door Outer Frame. BV*6G 6' head room.
- AS0443** Inspection Door Outer Frame. BV*6G 7' head room.
- 1 AS0285** Inspection Door Catch Pin Weld Assembly. BV84, BV*5G.
- 2 C14895** Lock Mounting Bracket. BV84G, BV85G & BV105G.
- 3 P10580** Push Button Handle. BV*4G, BV*5 outer inspection door handle supplied with 2 keys.
- 4 P1059** Internal Latch Mechanism. BV*4G & BV*5G.
- 5 P1070** Inspection Door Hinge. BV*4G & BV*5G.
- 6 AS0258** Inspection Door Latch Weld Assembly. BV*5 7' headroom & BV*6.
- 7 AS0254** Locking Bar hinge Bracket Top. BV5 7' headroom and BV*6.
AS0255 Locking Bar hinge Bracket Bottom. BV5 7' headroom and BV*6.
- 8 AS0266** Locking Bar Weld Assembly. BV6 6' headroom.
AS0256 Locking Bar Weld Assembly. BV125G & BV*6 7' headroom.
- 9 C00248** Inspection Door Opening Handle. BV125G 7' & BV1*6G.
- 10 C10224** Inspection Door Latch Handle Housing. BV125G 7' & BV1*6G.
- 11 AS1691** Lock Handle Assembly. BV125G 7' & BV1*6G.
- 12 P1314** Self Adhesive Foam Strip. 10mm x 6mm on a 15m roll, fitted to the inspection door.
- 13 P1378** Cord – Expanded Neoprene. Sold per metre, fitted to the inspection door frame.

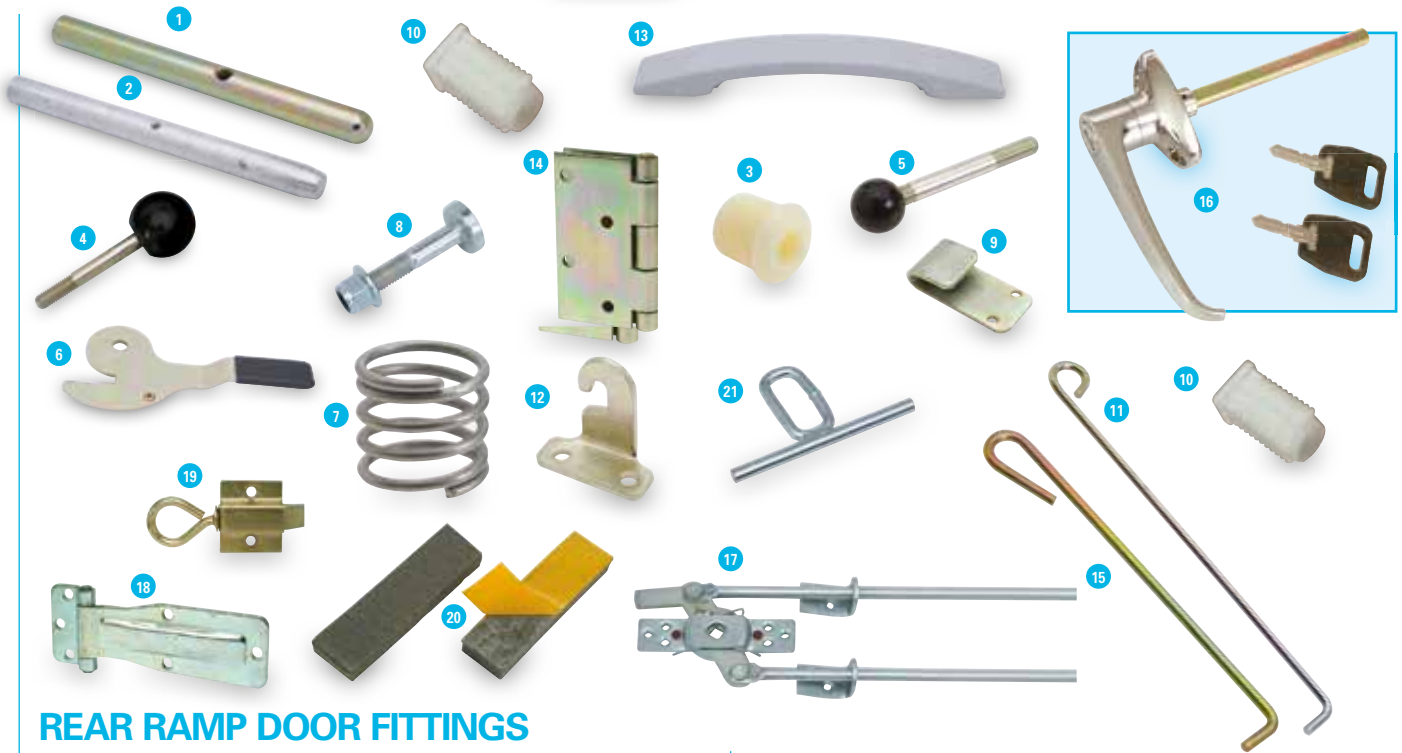

REAR RAMP DOOR FITTINGS

AS0278	Rear Corner Pillar. Right hand BV84G/ BV85G 5' headroom.
AS0279	Rear Corner Pillar. Left hand BV84G / BV85G 5' headroom.
AS0431	Rear Corner Pillar. Right hand BV*5G & BV*6 6' headroom.
AS0432	Rear Corner Pillar. Left hand BV*5G & BV*6 6' headroom.
AS0251	Rear Corner Pillar. Right hand BV*5G & BV*6 7' headroom.
AS0252	Rear Corner Pillar. Left hand BV*5G & BV*6 7' headroom.
1 C00049	Sliding Bolt. 3 per trailer, top and bottom fitted vertically. BV84G
P1173	Compression Spring. Used with the C00049 Sliding Bolt.
2 C40142	Sliding Bolt. 1per trailer, middle, fitted horizontally. BV84G
3 C70136	Spring Bolt Guide Bush. 4 per trailer.
4 P12361	M8 Pin and Knob. 3 per trailer.
5 P12362	M8 Pin and Knob. 1per trailer.
6 C14324	Ramp Closure Handle. Right hand.
C14325	Ramp Closure Handle. Left hand.
7 P1288	Spring. Ramp Closure.
8 C01690	Ramp Closure Lock Pin.
9 C11978	Reveiver - Ramp Closing Handle.
C20937	Ramp Hinge Tube.
P1246	Ramp Hinge Bush
P1163	Ramp Spring.
10 P1246	Hinge Pivot Bush.
11 C00256	Rear Door Stay. BV84G.
C00265	Rear Door Stay. BV*5G 6' headroom.
12 C04217	Ramp Spring Attachment Bracket. Right hand.
C04219	Ramp Spring Attachment Bracket. Left hand.
13 CP00172	Grab Handle.
CP00570	Grab Handle Spacer. 2 per handle required.
14 P1074	Butt Hinge.
C40318	Fog Lamp Mounting Plate.
C40319	Number Plate Mounting Panel.

VAN DOOR FITTINGS





AS0281	Rear Corner Pillar. Right hand. BV84G.
AS0282	Rear Corner Pillar. Left hand. BV84G.
AS1570	Rear Corner Pillar. Right hand. BV*5G & BV*6 6' headroom.
AS1571	Rear Corner Pillar. Left hand. BV*5G & BV*6 6' headroom.
AS1575	Rear Corner Pillar. Right hand. BV*5G & BV*6 7' headroom.
AS1576	Rear Corner Pillar. Left hand. BV*5G & BV*6 7' headroom.
15 C00120	Door Stay. BV84G.
C00256	Door Stay. BV85G .
C15307	Number Plate Panel.
16 P1054	Chrome Locking Handle. Supplied with 2 keys.
17 P1055	3 Way Rod Latch. BV84.
18 P1077	Hinge - Low Profile.
19 P12453	Slam Bolt - Ring Tail.
20 P1319	Self Adhesive Foam Strip. 15mm x 4mm. Sold per metre.

ROLLER SHUTTER FITTINGS

AS0281	Rear Corner Pillar. Right hand BV85 5' headroom.
AS0282	Rear Corner Pillar. Left hand BV85 5' headroom.
AS1570	Rear Corner Pillar. Right hand BV*5 6' & BV*6 6' headroom
AS1571	Rear Corner Pillar. Left hand BV*5 6' & BV*6 6' headroom.
AS1575	Rear Corner Pillar. Right hand BV*5 & BV*6 7' headroom.
AS1576	Rear Corner Pillar. Left hand BV*5 & BV*6 7' headroom.
21 AS7610	Roller Shutter Hasp
P1201	Roller Shutter Door Kit. BV85G 5' headroom.
P1200	Roller Shutter Door Kit. BV*5G 6' headroom.
P12012	Roller Shutter Door Kit. BV*6G 6' headroom.
P12011	Roller Shutter Door Kit. BV*6G 7' headroom.
KS2246	Roller Shutter Registration Plate Kit. BV6' & 7' headroom. Fold down number plate holder complete with hinges.



INSPECTION DOOR KITS

-  **KS2213** Inspection Door Kit. BV84G 5' Headroom. Includes hinges and push button handle.
-  **KS2207** Inspection Door Kit. BV85G & BV105G 6' Headroom. Includes hinges and push button handle.
-  **KS2212/6** Inspection Door Kit. BV106G & BV126G 6' Headroom. Includes hinges and lever handle assembly.
-  **KS2212** Inspection Door Kit. BV106G & BV126G 7' Headroom. Includes hinges and lever handle assembly.

REAR PROTECTION BRACKETS

-  **C10308** Rear Protection Bracket RH BV84G.
- C10309** Rear Protection Bracket LH BV84G.
- C10335** Rear Protection Bracket RH BV85G.
- C10336** Rear Protection Bracket LH BV85G.
- C10337** Rear Protection Bracket RH BV105G.
- C10338** Rear Protection Bracket LH BV105G.
- C10364** Rear Protection Bracket RH BV125G.
- C10365** Rear Protection Bracket LH BV125G.
- C10215** Rear Protection Bracket RH BV106G.
- C10216** Rear Protection Bracket LH BV106G.
- C10266** Rear Protection Bracket RH BV126G.
- C10267** Rear Protection Bracket LH BV126G.

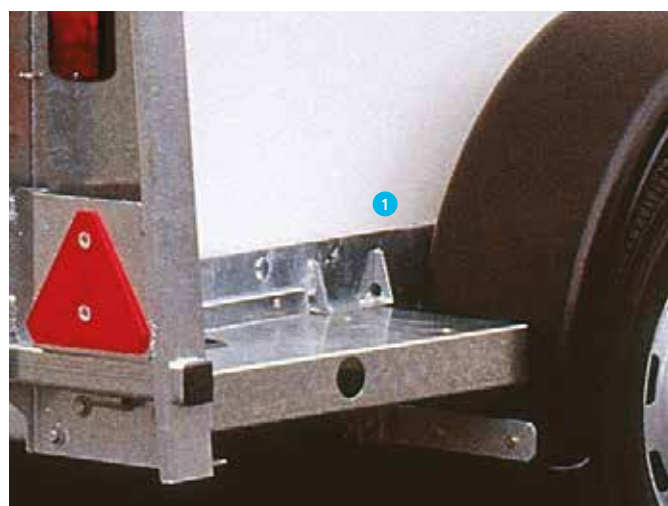



P8b with optional mesh sides fitted

DEDICATED KITS

	KX8636	Mesh Side Kit. P6b Ramp.
	KX8635	Mesh Side Kit. P6b Tailboard.
	KX8639	Mesh Side Kit. P7b Ramp.
	KX8638	Mesh Side Kit. P7b Tailboard.
	KX8642	Mesh Side Kit. P8b Ramp.
	KX8641	Mesh Side Kit. P8b Tailboard.
	KX8217	Ladder Rack. P6b & P7b.
	KX8218	Ladder Rack. P8b.
	KX4846	Internal Livestock Partition. P6b & P7b. For use with trailers fitted with a Canopy and Livestock Kit.

ACCESSORIES

	KS0229	Tailboard. P6b & P7b.
	KS0228	Tailboard. P8b.
	KS8510	Standard Ramp. P6b & P7b.
	KS8509	Stock Ramp. P6b & P7b.
	KS8613	Standard Ramp. P8b.
	KS8503	Ramp. P8b. 1.3m.
	KX0225	Propstand Kit.
	KX0651	Light Duty Lashing Point. One pair.
	KX8612	Lamp Guards. One pair.

SPARES FOR THE DRAWBAR & COUPLING

	AS3953	Drawbar Assembly. P6b.
	AS3954	Drawbar Assembly. P7b.
	AS3955	Drawbar Assembly. P8b.
	1 C13766	Drawbar Attachment Bracket. Right hand.
	C13767	Drawbar Attachment Bracket. Left hand.
	2 P00355PP	8 Pin Parking Socket.
	3 P0235	Jockey Wheel Clamp.
	WT5100-00040	Coupling Raiser. 40mm.

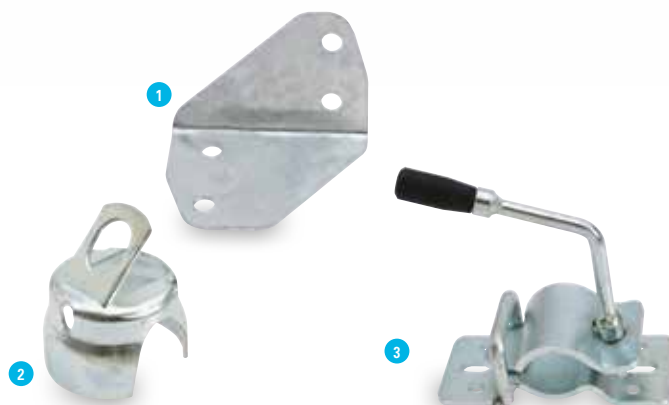

BODY COMPONENTS

	AS8240	Rear Frame. P6b & P7b.
	AS8252	Rear Frame. P8b.
	C15005	Floor Edge Strip. P6b & P7b.
	C15036	Floor Edge Strip. P8b.
	C04667	Rope Hook.
	C10770	Spare Wheel Bracket.
	C14419	Front Panel. P6b & P7b.
	C14462	Front Panel. P8b.
	C14423	Side Panel. Right hand, P6b.
	C14424	Side Panel. Left hand, P6b.
	C14426	Side Panel. Right hand, P7b.
	C14427	Side Panel. Left hand, P7b.
	C14460	Side Panel. Right hand, P8b.
	C14461	Side Panel. Left hand, P8b.

SPARES FOR THE RAMP & TAILBOARD

	AS8214	Ramp Hinge Pin. For ramp & tailboard.
	C14444	Number Plate Panel. For ramp & tailboard.
	C74427	Ramp Hinge Bush. For ramp & tailboard.













P6e with tailboard and 145/70R13 tyres



P7e ramp model





P6e & P7e DEDICATED KITS

-  **KX8635** **Mesh Side Kit P6e.** Tailboard models, full mesh sides kit also includes mesh rear panel, mesh ladder rack & all mounting hardware required.
-  **KX8636** **Mesh Side Kit P6e.** Ramp models, full mesh sides kit also includes mesh ladder rack & all mounting hardware required.
-  **KX8638** **Mesh Side Kit P7e.** Tailboard models, full mesh sides kit also includes mesh rear panel, mesh ladder rack & all mounting hardware required.
-  **KX8639** **Mesh Side Kit P7e.** Ramp models, full mesh sides kit also includes mesh ladder rack & all mounting hardware required.
-  **AS8219** **Mesh Ladder Rack.** P6e & P7e.
-  **AS8635** **Right Hand Side Mesh Panel.** P6e.
-  **AS8636** **Left Hand Side Mesh Panel.** P6e.
-  **AS8637** **Mesh Panel over Tailboard.** P6e & P7e.
-  **AS8638** **Right Hand Side Mesh Panel.** P7e.
-  **AS8639** **Left Hand Side Mesh Panel.** P7e.

BODY PANELS

- C14419** **Front Panel.** P6e/P7e.
- C14423** **Right Hand Side Panel.** P6e.
- C14424** **Left Hand Side Panel.** P6e.
- C14426** **Right Hand Side Panel.** P7e.
- C14427** **Left Hand Side Panel.** P7e.

P6e & P7e COMMON ACCESSORIES

- KX0652** **ATV Drawbar.**
-  **KX8217** **Ladder Rack.** Open framed design simply slots into the front of P6e and P7e.
-  **KS8510** **Ramp Kit.** Replacement standard ramp - ideal for conversions from tailboard.
-  **KS8509** **Stock Ramp.** Replacement ramp with small stock door built in (reversible door).
- 1** **KS0229** **Tailboard.** Complete tailboard assembly for P6e or P7e models.
- KX0630A** **Aluminium Canopy Door.** Complete with safety glass for P6e & P7e canopies.
- KX0630B** **Aluminium Canopy Door.** Solid panel (no window) for P6e & P7e canopies.
- KX8612** **Lamp Guards.** Pair of wire mesh guards to fit over the rear lamps.
- P1388** **Tarpaulin.** Blue elasticated tarpaulin cover tailored to fit the P6e trailer (tailboard models only).
- P1389** **Tarpaulin.** Blue elasticated tarpaulin cover tailored to fit the P7e trailer (tailboard models only).
-  **C49505** **Treadplate Floor.** Hardwearing aluminium floor for P6e.
-  **C49506** **Treadplate Floor.** Hardwearing aluminium floor for P7e.

SPARE PARTS

- P0567** **Jockey Wheel.** Simply replaces the existing front propstand.
- 2** **C14444** **Number Plate Panel.** Formed steel panel only.
- AS5106** **Spare Wheel Carrier.** For P6e & P7e with flotation or 145/70R13 tyres.
- AS5107** **Spare Wheel Carrier.** For P6e with 145R10 tyres.
- P00355DB** **Standard P6e Drawbar.** Swan neck style drawbar with coupling attached.
- P00355DB2** **Standard P7e Drawbar.** Swan neck style drawbar with coupling attached.













BV64e with ramp doors









P5 with P1387 Tarpaulin cover

BV64e MINI BOXVAN

-  **P12014 Roller Shutter Kit.**
-  **AS4522 Roof Rack Kit.** Incorporates tie-down points for lashing the load (BV64e van door models only, max roof rack weight limit 30kg).
-  **C41611 Treadplate Floor.** Hardwearing aluminium treadplate shaped to fit any BV64e.
- C81616 Rubber Matting.** Grippy rubber matting shaped to fit any BV64e.
- KX0651 Tie Ring Kit.** Pair of internal tie rings (floor mounted, includes fixing bolts).
- P0567 Jockey Wheel.** Simply replaces the existing front propstand.
- AS5875 Propstand.** Replacement galvanised propstand tube (priced each).
- C72160 Mudwing RH.** Moulded plastic wheel arch/wing with cutout for rear lighting.
- C72161 Mudwing LH.** Moulded plastic wheel arch/wing with cutout for rear lighting.
-  **C72162 Roof Moulding.** GRP Moulded roof as used on the roller shutter version.
-  **AS2466 RH Rear Door.** Includes hinges, locking mechanism & exterior locking handle.
-  **AS2467 LH Rear Door.** Includes hinges.
- P1055 Lock Rods.** Internal centre lock mechanism and upper/lower rod set.
-  **P1054 Chrome Locking Handle.** Used on the rear doors.
-  **P1070 Hinge.** Used on the rear doors.



P5 RANGE

-  **KX8612 Lamp Guards.** Pair of wire mesh guard to fit over the rear lamps.
-  **KX8613 Front Propstand Kit.** Includes stand, clamp & all mounting hardware required.
-  **KX8615 Jockey Wheel Kit.** Includes jockey wheel, clamp & all mounting hardware.
- KX8616 Ladder Rack Kit.** Includes corner sockets & all mounting hardware required.
- KX8627 Mesh Side Kit.** Tailboard models, Full mesh sides kit also includes mesh rear panel, mesh ladder rack, corner sockets & all mounting hardware required.
- KX8628 Mesh Side Kit.** Ramp models, Full mesh sides kit also includes mesh ladder rack, corner sockets & all mounting hardware required.
- AS8627 Mesh Side Panel Right Hand or Left Hand Side.** P5.
- AS8629 Mesh Panel over Tailboard.** P5.
- AS8193 Front Corner Socket.** Right hand, needed to secure the ladder rack.
- AS8194 Front Corner Socket.** Left hand, needed to secure the ladder rack.
- KS8610 Tailboard Kit.** P5 Tailboard assembly complete with hinge pins.
- KS8611 Ramp Kit.** P5 Ramp assembly complete with hinge pins.
- P1387 Tarpaulin.** Blue elasticated tarpaulin cover (tailboard models only).
-  **P12451 Rope Stud.** Round plastic stud (rivet fixed, rivet not included).
- P00355LDB Standard P5 Drawbar.** Swan neck style drawbar with coupling attached.
-  **KX0652 ATV Drawbar.** Longer straight drawbar to suit lower ATV couplings.
-  **KX0655 GRP Hardtop P5E.**





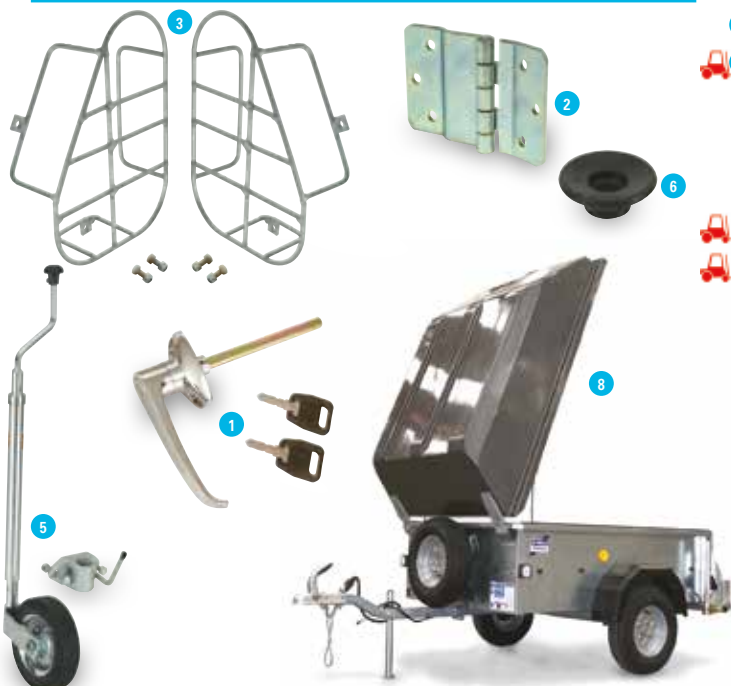

BODY PANELS

- C14431 Front Panel.**
-  **C14428 Right Hand Side Panel.**
-  **C14429 Left Hand Side Panel.**















DEDICATED KITS & COMPONENTS

-  **KX8641 Mesh Side Kit.** Tailboard model, full mesh side kit includes mesh ladder rack, mesh side panels, mesh rear panel & all mounting hardware required.
-  **KX8642 Mesh Side Kit.** Ramp model, full mesh side kit includes mesh ladder rack, mesh side panels & all mounting hardware required.
-  **AS8647 Mesh Ladder Rack.**
-  **AS8648 Right Hand Side Mesh Panel.**
-  **AS8649 Left Hand Side Mesh Panel.**
- AS8650 Mesh Panel over Tailboard.**
- P00355DB3 Drawbar Assembly.** Swan neck style drawbar with coupling attached.
-  **AS8252 Rear Frame Weld Assembly.**

BODY PANELS







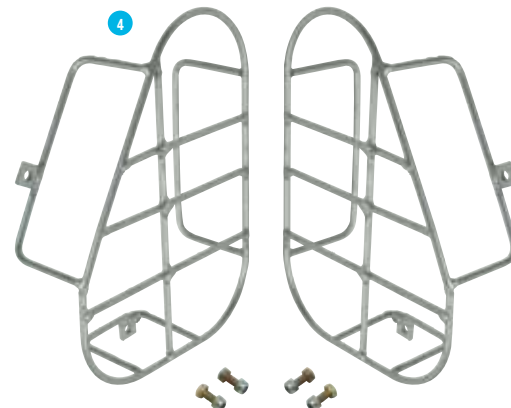









- C14462 Front Panel.**
-  **C14460 Right Hand Side Panel.**
-  **C14461 Left Hand Side Panel.**

ACCESSORIES

-  **KX8218 Ladder Rack.** Open framed design.
-  **KS8613 Ramp Kit.** Replacement standard ramp - ideal for conversions from tailboard.
-  **KS8508 Ramp Kit.** 1.3m.
-  **KS0228 Tailboard.** Complete tailboard assembly.
-  **P0567 Jockey Wheel.** 35mm diameter, replaces the front propstand.
-  **KX0225 Propstand Kit.** 1 pair of propstand legs, brackets and fittings.
-  **KX0651 Light Duty Lashing Point.** Supplied as a pair, ideal for use in all unbraked trailers.
-  **KX8612 Lamp Guards.** Pair of wire mesh guards to fit over the rear lamps.



DEDICATED KITS

-  **KX8650 Hinged Mesh Side Kit.** Q5e, the kit includes 2 mesh side panels and all mounting hardware.
-  **KX8651 Hinged Mesh Side Kit.** Q6e & Q6b, the kit includes 2 mesh side panels and all mounting hardware.
-  **KX8652 Hinged Mesh Side Kit.** Q7e & Q7b, the kit includes 2 mesh side panels and all mounting hardware.
-  **KX86521 Hinged Mesh Side Kit.** Q8b, the kit includes 2 mesh side panels and all mounting hardware.
-  **KX8653 Hinged Solid Side Kit.** Q5e, the kit includes 2 solid side panels and all mounting hardware.
-  **KX8654 Hinged Solid Side Kit.** Q6e & Q6b, the kit includes 2 solid side panels and all mounting hardware.
-  **KX8655 Hinged Solid Side Kit.** Q7e & Q7b, the kit includes 2 solid side panels and all mounting hardware.
-  **KX86551 Hinged Solid Side Kit.** Q8b, the kit includes 2 solid side panels and all mounting hardware.
-  **KX8656 Internal Livestock Partition.** Q5e, can be located in multiple locations allowing flexibility around the farm.
-  **KX8657 Internal Livestock Partition.** Q6e, Q7e, Q6b & Q7b, can be located in multiple locations allowing flexibility around the farm.
-  **KX8658 Internal Livestock Partition.** Q8b, can be located in multiple locations allowing flexibility around the farm.
-  **KX86595 Roof / Roof Rack Q5e.** This option is helpful for keeping contents dry as well as being able to carry fencing posts or a whole range of other materials (maximum weight 50kg).
-  **KX8659 Roof / Roof Rack.** Q6e & Q6b.
-  **KX8660 Roof / Roof Rack.** Q7e & Q7b.
-  **KX8661 Roof / Roof Rack.** Q8b.
-  **KX8644 Ramp Gates.** One pair, compatible with all but the Q5e.
- KX8645-A Spare Wheel Kit.** Compatible with the Q*e range fitted with the 20.5 x 8-10 floatation wheel, mounting bracket and all mounting hardware.
- KX8645-B Spare Wheel Kit.** Compatible with the Q*b range fitted with the 195/55R10C wheel, mounting bracket and all mounting hardware.



ACCESSORIES & SPARES

- KX0225 Propstand Kit.**
- KX8612 Light Guards.** One pair, compatible with the Q road range.
-  **P00270 360 Degree Swivel Hitch.** Compatible with the Q5e off road (not approved for road use).
- P0567 Jockey Wheel.** 35mm diameter, an option for the Q*e range.
- C40190 Alloy Mudguard.**



REAR DOORS ISUZU

KX0491A	Aluminium Door & Window. Compatible with the V491 canopy.
KX0419A	Aluminium Door & Window. Compatible with the V523 canopy.
KX0525A	Aluminium Door & Window. Compatible with the V524 & V525 canopies.
KX0528A	Aluminium Door & Window. Compatible with the V527 & V528 canopies (suitable for Isuzu D-Max, 2012 onwards models for canopies manufactured since January 2016).
KX0419	Mesh Tailgate. Compatible with the V491 & V523 canopies.
KX0525	Mesh Tailgate. Compatible with the V524 & V525 canopies.
KX0528	Mesh Tailgate. Compatible with the V527 & V528 canopies (suitable for Isuzu D-Max, 2012 onwards models for canopies manufactured since January 2016).

LAND ROVER

KX0379A	Aluminium Door & Window. Compatible with the V379, V381, V382 & V383 canopies.
KX0380A	Aluminium Door & Window. Compatible with the V380 & V386 canopies.
KX0379	Mesh Tailgate. Compatible with the V379, V381, V382 & V383 canopies.
KX0380	Mesh Tailgate. Compatible with the V380, & V386 canopies.

MAZDA / FORD

KX0387A	Aluminium Door & Window. Compatible with the V387, V388, V389, V395, V397, V398 & V399 canopies.
KX0419A	Aluminium Door & Window. Compatible with the V484, V485 & V486 canopies.
KX0398	Mesh Tailgate. Compatible with the V387, V388, V389, V395, V397, V398 & V399 canopies.
KX0419	Mesh Tailgate. Compatible with the V484, V485 & V486 canopies.

MITSUBISHI

KX0404A	Aluminium Door & Window. Compatible with the V404, V405, V406, V409 & V415 canopies.
KX0472A	Aluminium Door & Window. Compatible with the V411 canopy.
KX0412A	Aluminium Door & Window. Compatible with the V412 canopy.
KX0413A	Aluminium Door & Window. Compatible with the V413 canopy.
KX0414A	Aluminium Door & Window. Compatible with the V414 canopy.
KX0530A	Aluminium Door & Window. Compatible with the V530 canopy.
KX0404	Mesh Tailgate. Compatible with the V404, V405, V406, V409 & V415 canopies.
KX0472	Mesh Tailgate. Compatible with the V411 canopy.
KX0412	Mesh Tailgate. Compatible with the V412 canopy.
KX0413	Mesh Tailgate. Compatible with the V413 canopy.
KX0414	Mesh Tailgate. Compatible with the V414 canopy.
KX0530	Mesh Tailgate. Compatible with the V530 canopy.

NISSAN

KX0344A	Aluminium Door & Window. Compatible with the V344 canopy.
KX0345A	Aluminium Door & Window. Compatible with the V345, V346 & V424 canopies.
KX0417A	Aluminium Door & Window. Compatible with the V347, V348, V417 & V418 canopies.
KX0419A	Aluminium Door & Window. Compatible with the V419, V420, V421 & V422 canopies.
KX0417	Mesh Tailgate. Compatible with the V347, V348, V417 & V418 canopies.
KX0419	Mesh Tailgate. Compatible with the V419, V420, V421 & V422 canopies.
KX0344	Mesh Tailgate. Compatible with the V344 canopy.
KX0345	Mesh Tailgate. Compatible with the V345, V346 & V424 canopies.



TOYOTA

KX0419A	Aluminium Door & Window. Compatible with the V469, V4692, V4693 & V4694 canopies.
KX0462A	Aluminium Door & Window. Compatible with the V463, V466 & V467 canopies.
KX04691A	Aluminium Door & Window. Compatible with the V4691 canopy.
KX0412	Mesh Tailgate. Compatible with the V4691 canopy.
KX0419	Mesh Tailgate. Compatible with the V469, V4692, V4693 & V4694 canopies.
KX0462	Mesh Tailgate. Compatible with the V463, V466 & V467 canopies.

VOLKSWAGEN

KX0469A	Aluminium Door & Window. Compatible with the V499 canopy.
KX0469	Mesh Tailgate. Compatible with the V499 canopy.

ACCESSORIES

KX0480	Canopy Lock Kit. For Aluminium doors only, the kit includes 2 way rod lock and mounting plate, chrome locking handle and all fittings. This kit is a distributor supply & fit only.
KX0484	Gas Strut Assistor Kit. Compatible with mesh and aluminium doors on the V379, V381 & V383 Landrover canopies. The Kit includes 2 gas struts, gas strut brackets and all fittings. This kit is a distributor supply & fit only.
KX0485	Gas Strut Assistor Kit. Compatible with mesh and aluminium doors on all other canopy models. The Kit includes 2 gas struts, gas strut brackets and all fittings. This kit is a distributor supply & fit only.
KX0487	Canopy Side Door Kit. Can be fitted either side between the channels. This kit is a distributor supply & fit only.

SPARES

AS5094	Door Stay.
P1023	Door Stay Holder. Holds the door stay in place when not in use.
C11902	Antiluce Plate.
P1003D	Antiluce Fastener.
P1280	Rubber Washer / Antiluce Pad.
1 CP00172	Grab Handle.
CP00570	Grab Handle Spacer. 2 required per grab handle.
2 P1304	Rubber Seal. Sold per metre.
3 P1309	Rubber Seal. Sold per metre.
P1214	Safety Glass. For the rear aluminium doors.
P1326	Rubber Seal. Used to seal the safety glass in place. Sold per metre.
P1327	Rubber Filler Strip. Used with P1326. Sold per metre.
F1401Z	Hook Bolt. M8 x 60.
F1402Z	Hook Bolt. M8 x 70.
F1404Z	Hook Bolt. M8 x 90.
F1132Z	Coil Spring Washer.
F1089Z	Wing Nut. M8.



SIDE PANELS HB403 & HB506

1992mm x 1405mm x 12mm.

CP00256-01B	Silver.
CP00256-04B	Red.
CP00256-05B	White.
CP00256-06D	Bala Blue.
CP00256-08A	Black.
CP00256-12B	Graphite.

SIDE PANELS HB511

2206mm x 1405mm x 12mm.

CP00257-01B	Silver.
CP00257-04B	Red.
CP00257-05B	White.
CP00257-06D	Bala Blue.
CP00257-08A	Black.
CP00257-12B	Graphite.

FRONT LEFT HAND PANELS HB403 & HB506

With cut out for inspection door.

CP00264-01B	Silver.
CP00264-04B	Red.
CP00264-05B	White.
CP00264-06D	Bala Blue.
CP00264-08A	Black.
CP00264-12B	Graphite.

FRONT RIGHT HAND PANELS HB403 & HB506

With cut out for inspection door.

CP00265-01B	Silver.
CP00265-04B	Red.
CP00265-05B	White.
CP00265-06D	Bala Blue.
CP00265-08A	Black.
CP00265-12B	Graphite.

FRONT LEFT HAND PANELS HB511

With cut out for inspection door.

CP00267-01B	Silver.
CP00267-04B	Red.
CP00267-05B	White.
CP00267-06D	Bala Blue.
CP00267-08A	Black.
CP00267-12B	Graphite.

FRONT RIGHT HAND PANELS HB511

With cut out for inspection door.

CP00268-01B	Silver.
CP00268-04B	Red.
CP00268-05B	White.
CP00268-06D	Bala Blue.
CP00268-08A	Black.
CP00268-12B	Graphite.

INSPECTION DOOR PANELS HB403, HB506 & HB511

CP00269-01B	Silver.
CP00269-04B	Red.
CP00269-05B	White.
CP00269-06D	Bala Blue.
CP00269-08A	Black.
CP00269-12B	Graphite.

FRONT RAMP PANELS HB403 & HB506

988mm x 1525mm x 18mm.

CP00258-01B	Silver.
CP00258-04B	Red.
CP00258-05B	White.
CP00258-06D	Bala Blue.
CP00258-08A	Black.
CP00258-12B	Graphite.

FRONT RAMP PANELS HB511

1145mm x 1525mm x 18mm.

CP00259-01B	Silver.
CP00259-04B	Red.
CP00259-05B	White.
CP00259-06D	Bala Blue.
CP00259-08A	Black.
CP00259-12B	Graphite.

REAR RAMP PANELS HB403

1149mm x 1525mm x 18mm.

CP00260-01B	Silver.
CP00260-04B	Red.
CP00260-05B	White.
CP00260-06D	Bala Blue.
CP00260-08A	Black.
CP00260-12B	Graphite.

REAR RAMP PANELS HB506

1523mm x 1525mm x 18mm.

CP00261-01B	Silver.
CP00261-04B	Red.
CP00261-05B	White.
CP00261-06D	Bala Blue.
CP00261-08A	Black.
CP00261-12B	Graphite.

REAR RAMP PANELS HB511

1651mm x 1525mm x 18mm.

CP00262-01B	Silver.
CP00262-04B	Red.
CP00262-05B	White.
CP00262-06D	Bala Blue.
CP00262-08A	Black.
CP00262-12B	Graphite.



SIDE PANELS HB401 & HB505

1525mm x 2073mm x 12mm.

C992161	Silver.
C992163	Green.
C992164	Red.
C992166	Blue.
C992168	Black.

SIDE PANELS HB510

1525mm x 2292mm x 12mm.

C992051	Silver.
C992053	Green.
C992054	Red.
C992056	Blue.
C992058	Black.

FRONT LEFT HAND PANELS HB401 & HB505

445mm x 1525mm x 12mm.

C992081	Silver.
C992083	Green.
C992084	Red.
C992086	Blue.
C992088	Black.

FRONT LEFT HAND PANELS HB510

660mm x 1525mm x 12mm.

C992071	Silver.
C992073	Green.
C992074	Red.
C992076	Blue.
C992078	Black.

INSPECTION DOOR PANELS

604mm x 1434mm x 12mm.

C992061	Silver.
C992063	Green.
C992064	Red.
C992066	Blue.
C992068	Black.

FRONT RAMP PANELS HB401 & HB505

1525mm x 988mm x 18mm.

C992381	Silver.
C992383	Green.
C992384	Red.
C992386	Blue.
C992388	Black.



FRONT RAMP PANELS HB510

1525mm x 1145mm x 18mm.

C992201	Silver.
C992203	Green.
C992204	Red.
C992206	Blue.
C992208	Black.

REAR RAMP PANELS HB401

1525mm x 1098mm x 18mm.

C992211	Silver.
C992213	Green.
C992214	Red.
C992216	Blue.
C992218	Black.

REAR RAMP PANELS HB505

1525mm x 1513mm x 18mm.

C992391	Silver.
C992393	Green.
C992394	Red.
C992396	Blue.
C992398	Black.

REAR RAMP PANELS HB510

1525mm x 1620mm x 18mm.

C992551	Silver.
C992553	Green.
C992554	Red.
C992556	Blue.
C992558	Black.



BEAVERTAIL RANGE

C69501B	Finply Floor. LT/LM146B2 (3 sheets) 1220mm x 1965mm x 18mm.
C695011B	Finply Floor. LT/LM146B2 (1 sheet) 588mm x 1965mm x 18mm.
C69501B	Finply Floor. LT/LM166B2 (3 sheets) 1220mm x 1965mm x 18mm.
C695022B	Finply Floor. LT/LM166B2 (1sheet) 1155mm x 1965mm x 18mm.
C695136B	Finply Floor. LT/LM147B2 (3 sheets) 1220mm x 2235mm x 18mm.
C695139B	Finply Floor. LT/LM147B2 (1sheet) 558mm x 2235mm x 18mm.
C695136B	Finply Floor. LT/LM167B2 (4 sheets) 1220mm x 2235mm x 18mm.

BOX VAN RANGE

C61615	Profiled Finply Floor. BV64e.
C60965	Profiled Finply Floor. BV84G.
C60966	Profiled Finply Floor. BV85G.
C60969	Profiled Finply Floor. BV105G.
C60969 & C695121B	Profiled Finply Floor. Additional rear panel also required. BV125G.
C60968	Profiled Finply Floor. BV106G.
C60968 & C69565B	Profiled Finply Floor. Additional rear panel also required. BV126G.

EUROLIGHT RANGE

C69460B	Finply Floor. EL071-2012 & EL101-2012. 1250mm x 2025mm x 12mm.
C69461B	Finply Floor. EL071-2512, EL101-2512 & EL142- 2512. 1250mm x 2525mm x 12mm.
C69471B	Finply Floor. EL101-2515, EL141-2515, EL142- 3015 & EX202-3015. 1525mm x 2525mm x 15mm.
C69472B	Finply Floor. EL142-3015 & EX202-3015. 1525mm x 3025mm x 15mm.
C69473B	Finply Floor. EL142-3615 & EX202-3615. 1525mm x 3625mm x 15mm.

FLATBED RANGE

C60932	Finply Floor. LM/LT85G. (1sheet).
C60933	Finply Floor. LM/LT105G. (1sheet).
C60934	Finply Floor. LM/LT125G. (1 sheet).
C69501B	Finply Floor. LM/ LT106G. (2 sheets) 1220mm x 1965mm x 18mm.
C695011B	Finply Floor. LM/LT106G. (1 sheet) 588mm x 1965mm x 18mm.
C69501B	Finply Floor. LM/ LT126G. (2 sheets) 1220mm x 1965mm x 18mm.
C695020B	Finply Floor. LM/LT126G. (1 sheet)1175mm x 1965mm x 18mm.
C69501B	Finply Floor. LM/ LT146G. (3 sheets) 1220mm x 1965mm x 18mm.
C695012B	Finply Floor. LM/LT146G. (1 sheet) 572mm x 1965mm x 18mm.
C69501B	Finply Floor. LM166G. (3 sheets) 1220mm x 1965mm x 18mm.
C695015B	Finply Floor. LM166G. (1 sheet) 1188mm x 1965mm x 18mm.
C69501B	Finply Floor. LM186G. (4 sheets) 1220mm x 1965mm x 18mm.
C695013B	Finply Floor. LM186G. (1 sheet) 593mm x 1965mm x 18mm.
C695136B	Finply Floor. LM127G. (3 sheets) 1220mm x 2235mm x 18mm.
C695132B	Finply Floor. LM147G (1sheet) 572mm x 2235mm x 18mm.
C695136B	Finply Floor. LM147G. (3 sheets) 1220mm x 2235mm x 18mm.
C695134B	Finply Floor. LM167G (1sheet) 1188mm x 2235mm x 18mm.
C695136B	Finply Floor. LM167G. (3 sheets) 1220mm x 2235mm x 18mm.
C695133B	Finply Floor. LM187G (1sheet) 593mm x 2235mm x 18mm.
C695136B	Finply Floor. LM187G. (4 sheets) 1220mm x 2235mm x 18mm.
C695124B	Finply Floor. LM208 (5 sheets) 1220mm x 2460mm x 18mm.

GENERAL DUTY RANGE

C695074B	Finply Floor. GD64G Metric. 1245mm x 1885mm x 18mm.
C695073B	Finply Floor. GD84G Metric. 1245mm x 2500mm x 18mm.
C69507B	Finply Floor. GD85G Metric. 1570mm x 2500mm x 18mm.
C695071B	Finply Floor. GD105G Metric. 1570mm x 3115mm x 18mm.
C695072B	Finply Floor. GD125G Metric. 1570mm x 3730mm x 18mm.
C695051B	Finply Floor. GD106G Metric. 1765mm x 3115mm x 18mm.
C695052B	Finply Floor. GD126G Metric. 1765mm x 3730mm x 18mm.

GH RANGE

C69591B	Finply Floor. GH64. 1220mm x 2745mm x 24mm.
C69592B	Finply Floor. GH94 (Flatbed) 1300mm x 2745mm x 24mm.
C695921B	Finply Floor. GH94BT (Main floor sheet), 1300mm x 2150mm x 24mm.
C695922B	Finply Floor. GH94BT (Beavertail sheet), 1300mm x 560mm x 24mm.
C695675B	Finply Floor. GH1054 (Main floor sheet), 1616mm x 2500mm x 24mm.
C695676B	Finply Floor. GH1054 (Beavertail sheet), 1616mm x 465mm x 24mm.

GP RANGE

C69510B	Finply Floor. GP106 (2 sheets required) 1525mm x 1774mm x 21mm.
C69510B	Finply Floor. GP126. (2 sheets required).
C695102B	Finply Floor. GP126. (1 sheet required) 1525mm x 1774mm x 21mm.
C69510B	Finply Floor. GP146 (1 sheet required).
C695672B	Finply Floor. GP146 (1 sheet required) 2750mm x 1775mm x 21mm.
C69511B	Finply Floor. GP127. (2.5 sheets required) 1525mm x 1930mm x 21mm.
C69511B	Finply Floor. GP147. (1 sheet required).
C695113B	Finply Floor. GP147. (1 sheet required) 1716mm x 1930mm x 21mm.
C695114B	Finply Floor. GP147. (1 sheet required) 1039mm x 1930mm x 21mm.

GX RANGE

C695081B	Finply floor. GX84. 1250mm x 2425mm x 18mm.
C695661B	Finply Floor. GX85. 1575mm x 2425mm x 21mm.
C69566B	Finply Floor. GX105. 1575mm x 3025mm x 21mm.
C69570B	Finply Floor. GX125HD. 1575mm x 3675mm x 21mm.
C69568B	Finply Floor. GX106. 1840mm x 3025mm x 21mm.
C69569B	Finply Floor. GX126. 1840mm x 3675mm x 21mm.

TB TILTBED RANGE

C695032B	Finply Floor. TB4021-302 & TB4021-352. 1464mm x 3935mm x 18mm.
C69503B	Finply Floor. TB4621-302 & TB4621-352. 1464mm x 4508mm x 18mm.
C695084B	Finply Floor. TB5021-352 & TB5021-353. 1464mm x 4964mm x 18mm.
C695085B	Finply Floor. TB5521-353. 1464mm x 471mm x 18mm.
C695084B	Finply Floor. TB5521-353. 1464mm x 4964mm x 18mm.

CT TILTBED RANGE

C69501B	Finply Floor. CT166 (3 Sheets) 1220mm x 1965mm x 18mm.
C695022B	Finply Floor. CT166 (1 Sheet) 1155mm x 1965mm x 18mm.
C695136B	Finply Floor. CT167 (3 Sheets) 1220mm x 2235mm x 18mm.
C695137B	Finply Floor. CT167 (1 Sheet) 1155mm x 2235mm x 18mm.

Q RANGE SOFTWOOD PLANKS

C59051	Softwood Plank. Q5 (5 per trailer).
C59050	Softwood Plank. Q6 (6 per trailer).
C59052	Softwood Plank. Q7 (6 per trailer).
C59053	Softwood Plank. Q8 (7 per trailer).

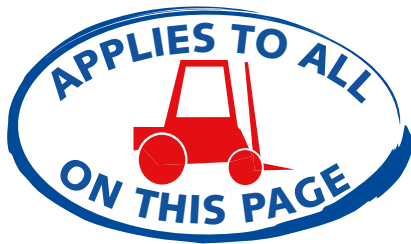

BEAVERTAIL RANGE

C49486	Treadplate. LT/LM146B2. 1960mm x 2990mm x 2mm.
C49505	Treadplate. LT/LM146B2. 1219mm x 1965mm x 2mm.
C49485	Treadplate. LM166B2. 1960mm x 3600mm x 2mm.
C49505	Treadplate. LM166B2. 1219mm x 1965mm x 2mm.
C49503	Treadplate. LM147B2 (3.5 sheets) 1219mm x 2438mm x 2mm.
C49503	Treadplate. LM167B2 (4 sheets) 1219mm x 2438mm x 2mm.

BOX VAN RANGE

C49496B	Treadplate. Cut to shape and size for the BV84G & BV85G. Please specify model of trailer when ordering.
C49495B	Treadplate. BV105G.
C49500	Treadplate. Cut to shape and size for the BV125G & BV126G. Please specify model of trailer when ordering.
C49490B	Treadplate. BV106G.

EUROLIGHT RANGE

KX3380	Treadplate. EL071-2012 & EL101-2012.
KX3382	Treadplate. EL071-2515, EL101-2512 & EL142-2512.
KX3384	Treadplate. EL101-2515, EL141-2515, EL142-2515, & EX202-2515.
KX3386	Treadplate. EL142-3015 & EX202-3015.
KX3388	Treadplate. EL142-3615 & EX202-3615.

FLATBED RANGE

C49497B	Treadplate. LT/LM85G. 1535mm x 2495mm x 2mm.
C49488	Treadplate. LT/LM105G. 1653mm x 2990mm x 2mm.
C49487	Treadplate. LT/LM125G. 1653mm x 3600mm x 2mm.
C49486	Treadplate. LT/LM106G. 1960mm x 2990mm x 2mm.
C49485	Treadplate. LM126G. 1960mm x 3600mm x 2mm.
C49489	Treadplate. LT/LM146G. 1960mm x 4215mm x 2mm.
C49485	Treadplate. LT/LM166G. 1960mm x 3600mm x 2mm.
C49505	Treadplate. LM166G. 1219mm x 1965mm x 2mm.
C49489	Treadplate. LM186G. 1960mm x 4215mm x 2mm.
C49505	Treadplate. LM186G. 1219mm x 1965mm x 2mm.
C49503	Treadplate. LM127G (3 sheets) 1219mm x 2438mm x 2mm.
C49503	Treadplate. LM147G (3.5 sheets) 1219mm x 2438mm x 2mm.
C49503	Treadplate. LM167G (4 sheets) 1219mm x 2438mm x 2mm.
C49503	Treadplate. LM187G (4.5 sheets) 1219mm x 2438mm x 2mm.
C495035	Treadplate. LM208. (5 sheets) 1219mm x 2480mm x 2mm

GENERAL DUTY RANGE

KX0658	Treadplate. GD64G Metric.
KX0659	Treadplate. GD84G Metric.
C49545	Treadplate. GD85G Metric. 1570mm x 2500mm x 2mm.
C49546	Treadplate. GD105G Metric. 1570mm x 3115mm x 2mm.
C495465	Treadplate. GD125G Metric. 1570mm x 3730mm x 2mm.

GH RANGE

KX35326	Treadplate. GH64.
KX35323	Treadplate. GH94.
KX35325	Treadplate. GH94BT.
KX35324	Treadplate. GH1054.

LIVESTOCK RANGE

C49505	Treadplate. P6G. 1219mm x 1965mm x 2mm.
C49503	Treadplate. P8G. 1219mm x 2438mm x 2mm.
C49497B	Treadplate. TA5G 8'. 1535mm x 2495mm x 2mm.
C49496B	Treadplate. TA5G 10'. 1535mm x 3110mm x 2mm.
C49495B	Treadplate. TA5G 12'. 1535mm x 3725mm x 2mm.
C49491B	Treadplate. TA510G 10'. 1765mm x 3110mm x 2mm.
C49490B	Treadplate. TA510G 12'. 1765mm x 3725mm x 2mm.
C49500	Treadplate. TA510G 14'. 1765mm x 4340mm x 2mm.
C49486	Treadplate. DP120G 10'. 1960mm x 2990mm x 2mm.
C49485	Treadplate. DP120G 12'. 1960mm x 3600mm x 2mm.
C49489	Treadplate. DP120G 14'. 1960mm x 4215mm x 2mm.

GP RANGE

C49491B	Treadplate. GP106. 1765mm x 3110mm x 2mm.
C49490B	Treadplate. GP126. 1765mm x 3725mm x 2mm.
C494895	Treadplate. GP127. 1930mm x 4270mm x 2mm.
C49500	Treadplate. GP146. 1765mm x 4340mm x 2mm.
C494895	Treadplate. GP147. 1930mm x 4270mm x 2mm.

GX RANGE

C494932	Treadplate. GX84. 1250mm x 2425mm x 2mm.
C494872	Treadplate. GX85. 1575mm x 2425mm x 2mm.
C494871	Treadplate. GX105. 1575mm x 3025mm x 2mm.
C494853	Treadplate. GX125HD. 1575mm x 3675mm x 2mm.
C494851	Treadplate. GX106. 1840mm x 3025mm x 2mm.
C494852	Treadplate. GX126. 1840mm x 3675mm x 2mm.

P*B, Q & UNBRAKED RANGE

C49502	Treadplate. P5 & Q5. 1020mm x 1520mm x 2mm.
C49505	Treadplate. P6 & Q6. 1219mm x 1965mm x 2mm.
C49506	Treadplate. P7 & Q7. 1219mm x 2195mm x 2mm.
C49510	Treadplate. P8 & Q8. 1449mm x 2495mm x 2mm.

CT TILTBED

C49485	Treadplate. CT166. 1960mm x 3600mm x 2mm.
C49505	Treadplate. CT166. 1219mm x 1965mm x 2mm.
C49503	Treadplate. CT167 (4 sheets) 1219mm x 2438mm x 2mm.

TT TIPPER RANGE – ALUMINIUM FLOORS

AS4445	Aluminium Floor Assembly. TT2515.
AS4446	Aluminium Floor Assembly. TT3017.
AS4447	Aluminium Floor Assembly. TT3621.

TRAILER IDENTIFICATION PLATES – FOR TRAILERS PRODUCED SINCE SEPTEMBER 2012

Your trailer will have two or three identification plates which are typically attached to the right hand side of the drawbar. These plates contain important information including the trailers serial number (also known as VIN number) and its max gross weight.

For trailers produced on or before Sept 2012, there will still be a VIN Plate, which carries the serial number in the same format as the new trailers. (There may not however be a Drawbar approval plate fitted)

STANDARD EC APPROVAL VIN PLATE

1	EC approval number	1
	VIN Number	2
	Gross vehicle weight	3
	Permissible mass on a single axle	4
	Permissible mass on a double axle	5
	Permissible mass on a triple axle	6
	Internal description	7

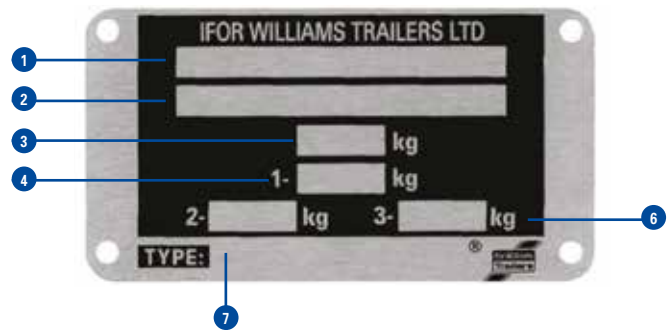

DRAWBAR APPROVAL PLATE

2	Trailer manufacturer	1
	Trailer model	2
	Drawbar variant code	3
	Maximum gross weight that can be fitted to this model of drawbar	4
	Theoretical horizontal reference force	5
	Max static load	6
	EC approval number	7

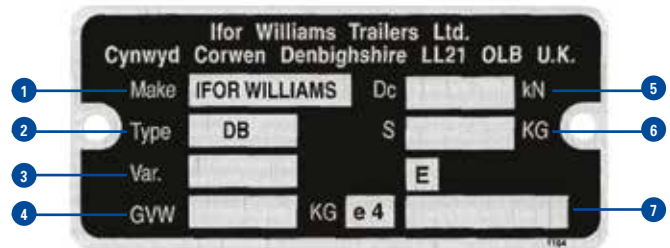

DOWN RATED TRAILER WEIGHT VIN PLATE

(Occasionally trailers are down rated (normally if the driver has not got B1 and E) towing entitlements. If it has been downrated this plate will be present.)

3	EC down-rated approval number - Country specific	1
	VIN Number	2
	Gross vehicle weight	3
	Permissible mass on axle 1	4
	Permissible mass on axle 2	5
	Internal description	6

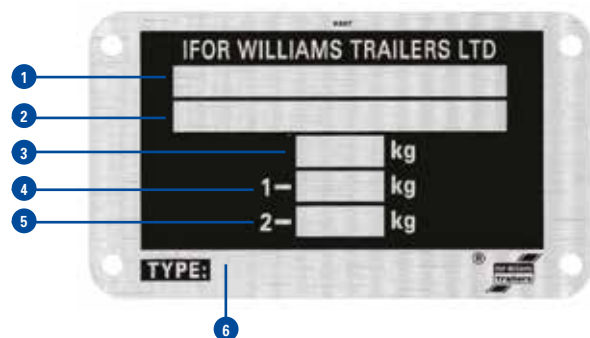

When ordering certain types of spare parts you will need to supply us with the serial number of the trailer. This identifies the age and batch reference of the trailer, which informs us of any changes to product specification around the date of manufacture. If you are ordering spares for more than one trailer, you will need to identify which serial number the parts are intended for.

HOW TO FIND YOUR SERIAL NUMBER

Every trailer we manufacture is fitted with a type plate (plate 2 – Standard EC approval VIN plate), this will have a unique serial number printed on it by multi-dot punching. An example of a standard type plate is shown opposite. All Ifor Williams Trailers serial numbers begin with the prefix SCK. This example is printed with the full 17 digit VIN (Vehicle Identification Number). The last 6 or 7 digits represent the serial number depending on the age and model of your trailer. Some models may be fitted with a slightly smaller plate; however, the serial number will still be present and easily recognisable.



BRAKED TRAILERS

For trailers with 'A Frame' drawbars the plate is located on the outside of the right hand drawbar member. On trailers with adjustable height couplings the plate is located on the right hand section of the supporting structure that the drawbar/coupling unit is clamped to.

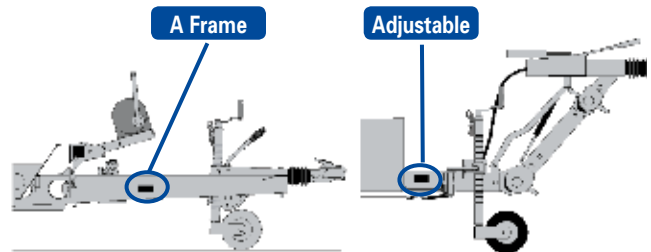

UNBRAKED TRAILERS

On P5/6/7e (unbraked) models the plate is fitted to the front panel of the trailer, or is sometimes attached to the drawbar mounting bracket. On BV64e boxvan models the plate is fitted to the right hand side of the rear cross member.

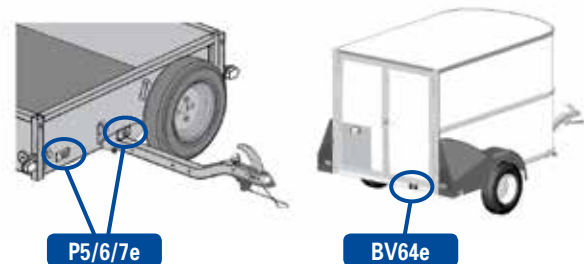

HB403 – SINGLE HORSEBOX

Unlike all other horsebox models, the HB403 has its plates fitted to the outer face on the right hand side directly below the front ramp.

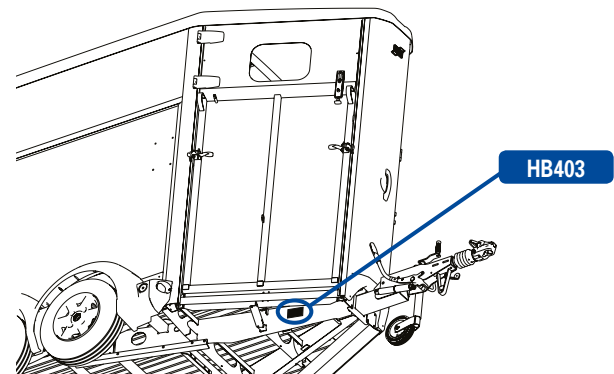

IDENTIFYING COUPLING TYPES

The coupling units fitted to your Ifor Williams trailer may be from one of several different manufacturers, when ordering spares for a coupling or brake linkage it is important to identify the manufacturer and model. Typically an overrun (brake control) coupling unit will be fitted with its own type plate, usually on the top or side of the main shaft housing. The example shown here is from Knott KF13 overrun coupling.

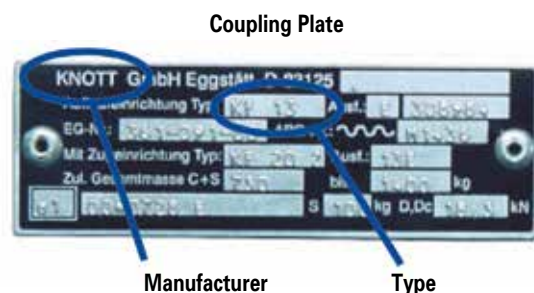

The Ifor Williams Trailers Distributor network maintains a large stock of spares and accessories and they will provide knowledgeable advice and information to assist you with identifying the correct spare part for your requirement.

The UK and Ireland Distributor network is shown overleaf.

For International inquiries, please contact the relevant local distributor via our website, www.iwt.co.uk/distributors

You can also order spares direct from Ifor Williams Trailers by emailing spares@iwt.co.uk or phoning **0845 4082 505**. Please note that heavy or bulky items, marked with the Forklift symbol, cannot be ordered directly from Ifor Williams Trailers Ltd. These items must be ordered through one of our distributors.



Our standard carriage cost is **£9.95*** inc VAT for UK mainland. Parcels weighing more than 20kg or exceeding 120cm in length will incur an additional carriage charge

* Northern Ireland, Irish Republic, Scottish Highlands & Islands, Isle of Man and Channel Islands, carriage prices in request.

When Ordering please note that the following:

Specification

Product design, descriptions, colours, specifications etc. correct at time of going to press. We constantly strive to improve our products, and from time to time this may result in changes to our range or to individual products. Please check that design, description, colours, specifications described in the catalogue are still valid at the time of placing an order. If in doubt as to the specification of your trailer and/or suitability of advertised spares or accessories please visit one of our distributors for advice. Our distributors have extensive product knowledge and will be pleased to offer assistance to customers seeking spare parts.

Availability

If any item ordered has become unobtainable our staff will make every effort to obtain a suitable alternative. However in the case of parts for very old or specially built trailers this may take extra time to process. If the part that you require is not listed or appears to be unavailable please telephone our spares department for advice. In some cases modifications are available which allow alternative parts to be fitted.



IFOR WILLIAMS TRAILERS DISTRIBUTORS - UK & IRELAND

Northern England

- 1 **Barlow Trailers Ltd**
Leyland (01772 600395)
sales@barlowtrailers.co.uk
- 2 **Guy Machinery Ltd**
Clitheroe (01200 445555)
parts@guymachinery.co.uk
- 3 **Alan Tuer Ltd**
Carlisle (01228 672407)
alantuer@btconnect.com
- 4 **Tony Sharp**
Broughton in Furness
(01229 716445)
tsharptrailers@btconnect.com
- 5 **Swillington Trailer Centre Ltd**
Leeds (0113 287 1463)
swillingtontc@btconnect.com
- 6A **Ripon Trailer Centre**
Ripon (01765 698948)
ripontc@riponfarmservices.co.uk
- 6B **Ripon Farm Services**
Hull (01964 622351)
ripontc@riponfarmservices.co.uk
- 6C **Ripon Farm Services**
Stockton (01740 630254)
ripontc@riponfarmservices.co.uk
- 7 **JG Paxton & Sons Ltd**
Pity Me, Durham (0191 3847111)
info@paxtons.co.uk
- 8A **Thomas Sherriff & Co Ltd**
Alnwick (01665 603555)
donaldj@thomassherriff.co.uk
- 8B **Thomas Sherriff & Co Ltd**
Berwick (01289 306697)
donaldj@thomassherriff.co.uk

Central England

- 9 **Barnwell Trailers Ltd**
Peterborough (01832 272218)
Giles@barnwelltrailers.co.uk
- 10 **HFB Trailers Leek Ltd**
Leek (01538 306212)
sales@hfbtrailers.com
- 11 **Norfolk Trailers Ltd**
Norwich (01603 404302)
sales@norfolktrailers.co.uk
- 12 **Morris Bufton & Co Ltd**
Ludlow (01584 872244)
john@morrisbufton.co.uk
- 13 **Ross Farm Machinery Ltd**
Ross on Wye (01989 768811)
postroom@rossfarm.co.uk
- 14 **Scott Trailers**
Walcott (01526 860317)
office@scott-trailers.co.uk
- 15 **T & A Trailers**
Aldridge (01922 452456)
mail@tatrailers.co.uk
- 16 **Whitehall Trailers**
Stockton (01926 812088)
whitehalltrailer@aol.com

South West England

- 17 **Boulter Mead Ltd**
North Petherton (01278 661586)
sales@boultermead.com
- 18 **Devizes Trailer Centre**
Devizes (01380 721758)
info@devizestailers.com
- 19 **CJ Cox Ltd**
Sturminster Newton
(01258 473176)
cjcoxstores@btconnect.com
- 20 **Winston Pincombe**
Chulmleigh (01769 580900)
winston.pincombe@btconnect.com
- 21 **P R J Engineering Ltd**
Launceston (01566 782794)
sales@prjengineering.co.uk
- 22 **Vincent Tractors Ltd**
St Columb (01726 860332)
stores@vincenttractors.co.uk

Central South England

- 23 **T H White Ltd**
Reading (01189 760088)
trailerspares@thwhite.co.uk
- 24 **Cotswold Trailers Ltd**
Cheltenham (01451 851007)
cotswold.trailer@outlook.com
- 25 **Blains Trailers & Tyres Ltd**
Hemel Hempstead (01442 842419)
blainstrailers@aol.com
- 26 **New Forest Farm Machinery Ltd**
Ringwood (01425 472572)
Parts@newforestfarm.com

South East England

- 27 **Agriservices**
Blackmore (01277 822516)
sales@agriservices.co.uk
- 28 **John Page Trailers**
Ashford (01580 291088)
contact@johnpagetrailers.co.uk
- 29 **Universal Trailers**
Billingshurst (01403 782862)
info@universal-trailers.co.uk
- 30 **G T Towing Ltd**
Hatfield (01707 262526)
sales@gttowing.co.uk
- 31 **Agroco Trailers Ltd**
Ipswich (01473 657571)
info@agrocotrailers.co.uk

Wales

- 32A **Ifor Williams Trailers Ltd**
Corwen (01490 412527)
sales@iwt.co.uk
- 32B **Ifor Williams Trailers Ltd**
Deeside (01244 281888)
sales@iwtdeeside.co.uk
- 33 **J & C Griffiths and Son**
Talgarth (01874 711317)
sales@jandcgriffithsandson.co.uk
- 34A **Riverlea Tractors Ltd**
Cowbridge (01446 775602)
parts.la@riverlea.co.uk
- 34B **Riverlea Tractors Ltd**
Whitland (01994 240644)
parts.wh@riverlea.co.uk
- 35 **Ross Farm Machinery Ltd**
Raglan (01291 690205)
postroom@rossfarm.co.uk
- 36 **Mason Bros**
Bridgend (01656 723655)
info@masonbros.co.uk

Scotland

- 37A **T H Jenkinson**
Castle Douglas (01556 504133)
tom@thjenkinson.co.uk
- 37B **T H Jenkinson**
Whitefordhill (01292 619193)
ayr@thjenkinson.co.uk
- 38 **Stirling Trailer Centre**
Stirling (01786 833424)
parts@stirlingtrailercentre.co.uk
- 39A **Thomas Sherriff & Co Ltd**
Coldstream (01890 840550)
donaldj@thomassherriff.co.uk
- 39B **Thomas Sherriff & Co Ltd**
Haddington (01620 823132)
donaldj@thomassherriff.co.uk
- 39C **Thomas Sherriff & Co Ltd**
Stow (01578 730282)
stow@thomassherriff.co.uk
- 39D **Thomas Sherriff & Co Ltd**
Dunbar (01368 862736)
sherriff.dunbar@thomassherriff.co.uk
- 40 **Duncan McIntosh Trailers Ltd**
Brechin (01356 624600)
spares@duncanmcintosh.co.uk
- 41A **D & R Alexander & Son**
Inverness (01463 248268)
sales@dralexanderson.co.uk
- 41B **D & R Alexander & Son**
Thurso (01847 811365)
sales@dralexanderson.co.uk
- 42A **Balgownie Ltd**
Inverurie (01467 621493)
info@balgownieltd.co.uk
- 42B **Balgownie Ltd**
Turrieff (01888 530800)
info@balgownieltd.co.uk

Northern Ireland

- 43A **A J C Lamont Trailers**
Coleraine (028 7034 3563)
info@lamonttrailers.com
- 43B **A J C Lamont Trailers**
Lisburn (028 9266 6804)
info@lamonttrailers.com
- 44 **THJenkinson & Co**
Armagh (028 3756 8484)
sales@jenkinsontrailers.co.uk

Ireland

- 45 **Westwood Trailers Ltd**
Naas 00353 (0)45 876053
parts@westwoodtrailers.com



IFOR WILLIAMS TRAILERS

Cynwyd, Corwen, Denbighshire LL21 0LB

TERMS AND CONDITIONS OF SALE

CONSUMER TERMS

These conditions apply when you are purchasing Goods from us as a Consumer.

PLEASE NOTE THAT THESE CONDITIONS CONTAIN TERMS WHICH EXCLUDE OR LIMIT OUR LIABILITY TO YOU.

1. DEFINITIONS AND INTERPRETATION

In these terms and conditions the following terms have the following meanings:

"Associate" means, in relation to us, any company that is our holding company, subsidiary or a subsidiary of our holding company and the expressions **"subsidiary"** and **"holding company"** shall have the same meaning as in Sections 736 and 736A of the Companies Act 1985 (as amended from time to time);

"Conditions" means these terms and conditions;

"Consumer" means any natural person who purchases Goods other than in the course of his or her business, trade or profession or for use in his or her business, trade or profession;

"Contract" means any contract for the sale by us and purchase by you of Goods;

"Delivery" means delivery of the Goods to you or, as the case may be, the Goods being ready for collection by you, and **"Deliver"** should be interpreted accordingly;

"Goods" means any goods to be sold and supplied by us to you;

"Price" means all sums payable by you to us for the Goods;

"us", "our" or "we" refers to the seller of Goods under a Contract which may be either Ifor Williams Limited or any of its Associates as named or identified in any acceptance of your order; and

"you" or "your" means the customer buying the Goods from us.

2. OUR CONTRACT WITH YOU

2.1 These are the Conditions on which we supply Goods to you.

2.2 Please ensure you read these Conditions carefully and check the details of your Contract are complete and accurate before you sign the Contract. If you think there is a mistake, please contact us to discuss. Where you do not sign the Contract your order of goods shall constitute an offer to purchase the Goods in accordance with these Conditions. You are responsible for ensuring that the terms of your order and any applicable specification submitted by you are complete and accurate.

2.3 These Conditions will become binding on you and us when we either (i) issue you with a written acceptance of the Contract; or (ii) we deliver the Goods to you. The processing of your payment and acknowledgement of your order does not constitute acceptance of your order.

2.4 This is not a sale by sample. Any showroom models, samples, drawings, descriptive matter or advertising shown to you or produced by us and any descriptions or illustrations contained on our website or in our catalogues or brochures are produced for the sole purpose of giving an approximate idea of the Goods referred to in them. They shall not form part of the Contract nor have any contractual force.

2.5 It is always possible that despite our best efforts, some of the Goods we sell may be incorrectly priced. We will normally check prices as part of our despatch procedures so that, where the Goods' correct price is less than our stated price, we will charge you the lower amount when dispatching the Goods to you. If the Goods' correct price is higher than the price stated on our website or in our catalogue or brochure we will contact you to tell you and ask for your instructions. If the pricing error is obvious and unmistakable and could have reasonably been recognised by you as a mispricing we do not have to provide the Goods to you at the incorrect (lower) price.

2.6 If you request amendments to the Goods ("Bespoke Goods") we will make the amendments according to the instructions you give us. We cannot accept the return of Bespoke Goods if the reason for return is because you provided us with incorrect amendments. This will not affect your legal rights as a consumer in relation to Bespoke Goods that are faulty or not as described.

2.7 We are a company registered in England and Wales. Our company registration number is 01206036 and our address is set out at the start of these conditions. Our registered VAT number is VAT GB162990737

2.8 If you have any questions or if you have any complaints, please contact us. You can contact us by telephoning our customer service team at +44 (0)843 216 7447 or by e-mailing us at customer.care@iwt.co.uk

2.9 If you wish to contact us in writing, or if any clause in these Terms requires you to give us notice in writing (for example, to cancel the contract), you can send this to us by e-mail, by hand, or by pre-paid post to our address set out at the start of these conditions. We will confirm receipt of this by contacting you in writing. If we have to contact you or give you notice in writing, we will do so by e-mail, by hand, or by pre-paid post to the address you provide to us in the order.

3. SECOND-HAND GOODS

In relation to second-hand or used Goods which we sell to you such Goods are sold "as seen". We make no representations and gives no warranties as to the quality, condition, state or description of the Goods, or their fitness or suitability for any purpose. All implied statutory or common law terms, conditions and warranties as to the Goods are excluded to the fullest extent permitted by law. Upon request we will permit you to inspect the Goods for the purpose of assessing whether they are of satisfactory quality or not, you will be deemed to have carried out a reasonable examination of them before the Contract is made, whether or not you have actually taken the opportunity to do so.

4. CANCELLATION

4.1 In the case of contracts made by telephone, mail order, email, facsimile or on the internet you may cancel the Contract by giving us notice in writing at any time on or before the expiry of fourteen days from the day after the date of delivery by us or collection by you of the Goods. Where you exercise this right of cancellation you must promptly return the Goods to us and pay the cost of doing so. Pending your return of the Goods to us, you must take reasonable care of the Goods and retain possession of them.

4.2 If you cancel your Contract pursuant to clause 4.1 we will refund you the price you paid for the Goods. However, please note we are permitted by law to reduce your refund to reflect any reduction in the value of the goods, if this has been caused by your handling them in an unreasonable way or in a way which would not be permitted in a showroom. If we refund you the price paid before we are able to inspect the goods and later discover you have handled them in an unacceptable way, you must pay us an appropriate amount.

4.3 We may have to cancel a Contract before the Goods are delivered, due to an Event Outside Our Control or the unavailability of stock. If this happens:

- we will promptly contact you to let you know;
- If you have made any payment in advance for Goods that have not been delivered we will refund those amounts to you.

5. PRICE AND PAYMENT

5.1 The Price is exclusive of VAT which is payable by you in addition to the Price

5.2 If you pay by credit or debit card we are entitled to charge an additional amount which is limited to the additional charges we will incur.

5.3 Except where payment is made by you at the time of entering into a Contract, you will pay us for the Goods in accordance with any terms we have notified to you before the Contract is made. If we have not provided you with any such notification, the Price will be payable on Delivery.

5.4 Either you or we (as appropriate) will have the right to charge the other interest on any overdue amounts from the date payment falls due until the day immediately prior to the date payment is made (whether before or after judgment) at the rate of 8% above the Bank of England base rate from time to time. Such interest will accrue on a daily basis and be compounded annually.

5.5 If you fail to pay the Price on the date on which payment becomes due we will be entitled (without prejudice to any other right or remedy we may have) to suspend any further Delivery to you under the same or any other Contract until actual payment is made in full.

6. DELIVERY AND RISK

6.1 If we deliver the Goods to you we will charge you for the cost of delivery in addition to the Price and in accordance with our published terms for such costs in force at the time the Contract is made. The costs of delivery will be as told to you during the order process.

6.2 We will use our reasonable endeavours to Deliver the Goods on the date agreed between you and us or, if no date is agreed, within a reasonable time. However, our obligation to deliver the Goods to you is suspended for such period of time during which we are prevented, hindered or delayed in doing so due to unforeseen events or circumstances beyond our reasonable control. When we are no longer prevented, hindered or delayed in making Delivery of any Goods to you then we will Deliver them to you as soon as reasonably possible.

6.3 If we delay Delivery of any Goods (either due to our fault or where our obligation to Deliver is suspended) for a period of 30 days or more then you are entitled by written notice to cancel the Contract in respect of those Goods affected by the delay. However, you may not cancel in respect of any Goods which we Deliver prior to your sending us such notice.

6.4 If the Contract requires you to collect the Goods, the risk of loss or damage to them passes to you on collection. If the Contract requires us to deliver the Goods to you, risk passes to you on handover of the Goods at the agreed delivery address.

7. EVENTS OUTSIDE OUR CONTROL

7.1 We will not be liable or responsible for any failure to perform, or delay in performance of, any of our obligations under these Conditions that is caused by an Event Outside Our Control.

7.2 An "Event Outside Our Control" means any act or event beyond our reasonable control, including without limitation strikes, lock-outs or other industrial action by third parties, civil commotion, riot, invasion, terrorist attack or threat of terrorist attack, war (whether declared or not) or threat or preparation for war, fire, explosion, storm, flood, earthquake, subsidence, epidemic or other natural disaster, or failure of public or private telecommunications networks.

7.3 If an Event Outside Our Control takes place that affects the performance of our obligations under these Conditions:

- we will contact you as soon as reasonably possible to notify you; and
- our obligations under these Conditions will be suspended and the time for performance of our obligations will be extended for the duration of the Event Outside Our Control. Where the Event Outside Our Control affects Our delivery of Goods to you, We will arrange a new delivery date with you after the Event Outside Our Control is over.

7.4 You may cancel the contract if an Event Outside Our Control takes place and you no longer wish us to provide the Goods.

8. IF THE GOODS ARE FAULTY

8.1 As a consumer, you have legal rights in relation to Goods that are faulty or not as described. Advice about your legal rights is available from your local Citizens' Advice Bureau or Trading Standards office. Nothing in these Terms will affect these legal rights.

8.2 We warrant that on delivery and for a period of 12 months from delivery, the Goods shall be free from material defects. However, this warranty does not apply in the circumstances described in clause 8.3.

8.3 This warranty does not apply to any defect in the Goods arising from:

- fair wear and tear;
- wilful damage, abnormal storage or working conditions, accident;
- negligence by you or by any third party;
- if you fail to operate or use the Goods in accordance with the user instructions;
- any alteration or repair by you or by a third party who is not one of our authorised repairers; and
- any specification provided by you.

8.4 This warranty is in addition to, and does not affect, your legal rights in relation to the Goods that are faulty or not as described.

8.5 During the warranty period we will (at our option) do any of the following: refund all or any of the Price, repair or replace the Goods or any part of them (or procure such repair or replacement) to the extent that the Goods or part do not comply with the Contract as at the date of Delivery.

8.6 To take advantage of the Warranty you or any subsequent owner of the Goods in question must notify us at the address shown in the invoice promptly and in any event within twenty-eight (28) days of the relevant problem being discovered and permit us to inspect the Goods. If we do not receive notice of the problem within this timeframe then we will have no obligations under the warranty in respect of that problem.

8.7 Following notification of such problem we will use our reasonable efforts to inspect and/or repair and/or replace the relevant Goods or part within a reasonable time. If you arrange for a third party to carry out any repairs or work (subject to the exception just mentioned) then we will have no further obligations to repair or replace in respect of the applicable problem under this Warranty unless you have informed us in advance and we have consented to the work being done.

9. OWNERSHIP OF GOODS

Ownership of and title to the Goods passes to you only when we receive payment in full in cleared funds of the Price together with any VAT, delivery and other charges under the Contract.

10. NOTIFICATION OF PROBLEMS

If any of the Goods are faulty or damaged then you must notify us as soon as practicable after the fault or damage is discovered. Your notice must describe the fault or damage in question.

11. LIMITATION OF LIABILITY

11.1 We will not be liable for any loss or damage caused by any breach of the Contract by us except to the extent that such loss or damage is a reasonably foreseeable consequence of the breach. What is foreseeable is determined at the time the Contract is entered into. However, this limitation on our liability does not apply to personal injury or death caused by our negligence or to fraudulent representations, acts or omissions.

11.2 We are supplying the Goods on the basis that they are for domestic and private use only and will not be used for any commercial, business or re-sale purpose; as such, we shall have no liability to you for any loss of profit, loss of business, business interruption or loss of business opportunity.

11.3 We do not exclude or limit in any way our liability for:

- death or personal injury caused by our negligence or the negligence of our employees, agents or subcontractors;
- fraud or fraudulent misrepresentation;
- breach of the terms implied by section 12 of the Sale of Goods Act 1979 (title and quiet possession);
- breach of the terms implied by sections 13,14 and 15 of the Sale of Goods Act 1979 (description, satisfactory quality, fitness for purpose and samples); and
- defective products under the Consumer Protection Act 1987.

12. THIRD PARTY RIGHTS

No term of the Contract will be enforceable by virtue of the Contracts (Rights of Third Parties) Act 1999 by any person that is not a party to the Contract.

13. LAW

The Contract will be governed by and construed in accordance with the laws of England and you and we submit to the non-exclusive jurisdiction of the English courts.

IFOR WILLIAMS TRAILERS

Cymwyd, Corwen, Denbighshire LL21 0LB

TERMS AND CONDITIONS OF SALE

BUSINESS SALES

These conditions apply when you are purchasing Goods from us other than as a Consumer.

1. DEFINITIONS AND INTERPRETATION

1.1 In these terms and conditions the following terms have the following meanings:

"Associate" means, in relation to us, any company that is our holding company, subsidiary or a subsidiary of our holding company and the expressions **"subsidiary"** and **"holding company"** shall have the same meaning as in Sections 736 and 736A of the Companies Act 1985 (as amended from time to time);

"Authorised Distributor" means a distributor who has been authorised by us or any Associate to sell, maintain and repair the Goods;

"Conditions" means these terms and conditions for the sale and purchase of Goods;

"Consumer" means any natural person who purchases Goods other than in the course of his or her business, trade or profession or for use in their business, trade or profession;

"Contract" means any contract for the sale by us and purchase by you of Goods;

"Delivery" means delivery of the Goods by us to the applicable place of destination or, as the case may be, the Goods being ready for collection by you;

"Goods" means any goods to be supplied by us to you;

"Price" means all sums payable by you to us for the Goods;

"us", **"our"** or **"we"** refers to the seller of the Goods under a Contract which is Ifor Williams Trailers Limited or any of its Associates which is named or identified as seller in any acceptance of your order or otherwise in the course of formation of the Contract in question; and

"Trailer" means Goods comprising any trailer, transporter, horsebox container or pick-up canopies or similar, but excluding spare parts and accessories, which are manufactured or assembled in volume by us or any of our Associates or in accordance with specifications and production standards provided by us or any of our Associates;

"you" or **"your"** refers to the customer buying the Goods from us.

1.2 In these Conditions, unless otherwise stated:

- the singular includes the plural and vice versa;
- cognate expressions derived from the above definitions shall be construed accordingly; and
- "in writing" includes emails.

1.3 Where you are an Authorised Distributor the Contract is also subject to the terms of your distributor agreement.

2 APPLICATION OF CONDITIONS AND FORMATION OF CONTRACT

2.1 These Conditions apply to all Contracts where you are purchasing other than as a Consumer and exclude and supersede all other terms and conditions (including without limitation any terms or conditions which you purport to apply under any purchase order, confirmation of order or other document or through any course of dealing).

2.2 In the case of your order for a Trailer, the Contract between you and us is formed only when we allocate a serial number for a Trailer so ordered on our electronic order processing system and, in the case of any other Goods, only when we record your order as a confirmed order on that system.

2.3 The images of the Goods on our website or in our catalogue or brochure are for illustrative purposes only. Your Goods may vary slightly from those images.

2.4 It is always possible that despite our best efforts, some of the Goods we sell may be incorrectly priced. We will normally check prices as part of our despatch procedures so that, where the Goods' correct price is less than our stated price, we will charge you the lower amount when dispatching the Goods to you. If the Goods' correct price is higher than the price stated on our website or in our catalogue or brochure we will contact you to tell you and for your instructions. If the pricing error is obvious and unmistakable and could have reasonably been recognised by you as a mispricing we do not have to provide the Goods to you at the incorrect (lower) price.

3 PRICE AND PAYMENT

3.1 The Price is exclusive of VAT which is payable by you in addition to the Price.

3.2 Except where payment is made by you immediately on entering into the Contract, you will pay us for the Goods in accordance with any terms we have notified to you before the Contract is made. If we have not provided you with any such notification, the Price will be payable not later than the date of Delivery.

3.3 Unless we expressly agree otherwise, you must pay all invoices by BACS direct payment or by such other means of electronic funds transfer as we approve to such bank account as we have notified or may notify to you for this purpose from time to time.

3.4 Without prejudice to any other rights or remedies to which we may be entitled, we will have the right to charge you interest on any overdue amounts from the date payment falls due until the day immediately prior to the date payment is made (whether before or after judgment) at the rate of 8% above the Bank of England base lending rate. Such interest will accrue on a daily basis and be compounded annually.

3.5 If you fail to pay the Price on the date on which payment becomes due we and our Associates will be entitled (in addition to any other remedies we may have) to suspend any further Delivery to you under the Contract in question or any other contract until actual payment is made in full.

4 DELIVERY AND RISK

4.1 We will deliver the Goods to you to an agreed place of destination.

4.2 We will charge you for the cost of delivery in addition to the Price (if not included within the price) in accordance with our published terms for such costs in force when the Contract is made.

4.3 Subject to Condition 4.4, risk passes to you on Delivery.

4.4 Where the agreed place of destination is your premises, you must ensure that safe, adequate and accessible unloading and discharging facilities (including manual labour) and arrangements are available at the delivery address for unloading the Goods upon their arrival and, without prejudice to the generality of the foregoing, must ensure that such unloading and discharging facilities and arrangements comply with any applicable health and safety legislation, rules and/or regulations in force from time to time. You will be responsible for and bear the risk of any damage caused to the Goods or the property of any person and/or any injury suffered by any person during off-loading of the Goods at that place.

4.5 If we delay in delivering any Goods to you for a period of not less than 30 days then following expiry of that period you are entitled by not less than 5 days' written notice to cancel the Contract in respect of those Goods affected by the delay, but you are not otherwise entitled to cancel for delay. However, you may not cancel in respect of any Goods which we Deliver prior to your sending us such notice or the expiry of such notice.

4.6 We shall not be liable to you for any loss caused by late Delivery of the Goods.

4.7 Immediately upon the Goods being Delivered to you, you must carry out with reasonable care and diligence a visual examination thereof and promptly report to us any damage, defect or failure to comply with the Contract which is disclosed by such examination. Such report must be made so as to be received by us on the same day on which Delivery is made. Except to the extent of such report, the Goods will be deemed free from such damage, defect or lack of compliance as is or ought reasonably to be apparent upon examination being carried out in accordance with this Condition.

5 OWNERSHIP OF THE GOODS

5.1 Ownership of the Goods does not pass to you unless and until we receive payment in full in cleared funds of the Price together with any VAT, delivery and other charges under the Contract and of any other sums which are due by you under any other contract between us and you. We may maintain an action for the Price of Goods supplied to you notwithstanding that the property in and title to them has not passed to you.

5.2 Until title to the Goods passes to you, you:

- must at your expense insure the Goods for their full replacement value against all usual risks;
- must keep the Goods safe and in good condition, stored separately and clearly identifiable as our property; and
- must not sell or part with possession or control of the Goods other than a sale of them in good faith and in the ordinary course of your business. Your right to possession of the Goods will terminate immediately on notice from us which we may serve if you are in default under the Contract or on termination of the Contract by us or automatically if any of the events referred to in Condition 10 occurs in respect of you.

5.3 If we lawfully terminate your right to possession of the Goods then, in addition to any other remedies we may have, we or any person authorised by us will have the right to enter upon any premises occupied by you where the Goods are or may be stored in order to inspect the Goods or take possession of them and you hereby irrevocably authorise us and/or our authorised representative to enter upon your premises for such purposes.

6 WARRANTY

6.1 Providing the Goods are sold as new, the Supplier warrants that on delivery, and for a period of 12 months from the date of delivery ("warranty period" except to the extent the Customer is an Authorised Distributor in which case the "warranty period" shall have the meaning given in clause 6.7), then the Goods shall:

- conform in all material respects with the description given for them by the Supplier; and
- be free from material defects in design, material and workmanship.

6.2 Subject to clause 6.3, if:

- the Customer gives notice in writing to the Supplier during the warranty period within seven (7) days of discovery that some or all of the Goods do not comply with the warranty set out in clause 6.1;
- the Supplier is given a reasonable opportunity of examining such Goods; and
- the Customer (if asked to do so by the Supplier) returns such Goods to the Supplier's place of business at the Customer's cost, the Supplier shall, at its option, repair or replace the defective Goods, or refund the price of the defective Goods in full.

6.3 The Supplier shall not be liable for Goods' failure to comply with the warranty set out in clause 6.1 in any of the following events:

- the Customer fails to notify the Supplier of the defect within seven (7) days of its discovery;
- the Customer makes any further use of such Goods after giving notice in accordance with clause 6.2;
- the defect arises because the Customer failed to follow the Supplier's oral or written instructions as to the storage, commissioning, installation, use and maintenance of the Goods or (if there are none) good trade practice regarding the same;
- the defect arises as a result of the Supplier following any drawing, design or Specification supplied by the Customer;
- the Customer alters or repairs such Goods without the written consent of the Supplier;
- the defect arises as a result of fair wear and tear, wilful damage, negligence, or abnormal storage or working conditions; or
- the Goods differ from their description as a result of changes made to ensure they comply with applicable statutory or regulatory requirements.

6.4 Except as provided in this clause 6.4, the Supplier shall have no liability to the Customer in respect of the Goods' failure to comply with the warranty set out in clause 6.1.

6.5 The terms implied by sections 13 to 15 of the Sale of Goods Act 1979 are, to the fullest extent permitted by law, excluded from the Contract.

6.6 These Conditions shall apply to any repaired or replacement Goods supplied by the Supplier.

6.7 The warranty period in the case of purchases by Authorised Distributors shall be the period commencing on the date of Delivery and which ends on the earlier of (i) the expiry of twelve (12) months from the date of delivery to the customer who is the end user of the Goods for their intended purpose upon resale of the Goods to that customer by the Authorised Distributor or any subsequent intermediary or (ii) the expiry of eighteen (18) months commencing on the date of Delivery.

6.8 Unless we have expressly agreed otherwise with you in writing, we do not warrant that the Goods comply with the legal requirements as to quality or technical standards and/or performance of any jurisdiction other than those type D1 and type O2 trailers which comply with the relevant European Whole Vehicle Type Approval regulations as applied in the United Kingdom to the extent that those legal requirements would otherwise impose obligations on us under the Contract which are different, more strict or more onerous than those imposed on us by reference to the legal requirements of the United Kingdom and/or the Republic of Ireland as at the date of Delivery. Accordingly, we will not be liable for any loss or damage caused to you or any other person due to the Goods not complying to that extent with such legal requirements.

7 SECOND-HAND GOODS

In relation to second-hand or used Goods which we sell to you such Goods are sold "as seen". The Supplier makes no representations and gives no warranties as to the quality, condition, state or description of the Goods, or their fitness or suitability for any purpose. All implied statutory or common law terms, conditions and warranties as to the Goods are excluded to the fullest extent permitted by law. Upon request we will permit you to inspect the Goods for the purpose of assessing whether they are of satisfactory quality or not, you will be deemed to have carried out a reasonable examination of them before the Contract is made, whether or not you have actually taken the opportunity to do so.

8 EXCLUSIONS AND LIMITATION OF LIABILITY

8.1 Nothing in these Conditions excludes or limits our liability:

- for death or personal injury caused by our negligence or the negligence of any our employees while acting in the course of their employment;
- for any matter which it would be illegal for us to exclude or attempt to exclude our liability; or
- fraud or fraudulent misrepresentation; or
- breach of the terms implied by section 12 of the Sale of Goods Act 1979; and
- breach of section 2 of the Consumer Protection Act 1987;

8.2 Subject to clause 8.1

- our total liability in contract, tort (including without limitation negligence or breach of statutory duty), misrepresentation, restitution or otherwise, arising out of or in connection with our performance of or our failure to perform the Contract will be limited to the Price; and
- we shall not under any circumstances whatever be liable, whether in contract, tort (including negligence) or restitution, or for breach of statutory duty or misrepresentation, or otherwise, for any loss of profit, or loss of goodwill, or loss of business, or loss of business opportunity, or loss of anticipated saving, or loss or corruption of data or information; or special, indirect or consequential damage

9 FORCE MAJEURE

If we are prevented, hindered or delayed in performing any of our obligations under the Contract by reason of any unforeseen event or circumstance beyond our reasonable control (including for example and without limitation non-availability of materials or necessary inputs from our suppliers), such failure will not be a breach of our obligations and we will be entitled to suspend performance of those obligations for such period of time during which we are prevented, hindered or delayed in doing so. When we are no longer prevented, hindered or delayed then we will resume performance of our obligations so far as reasonably practicable at that time and as soon as reasonably possible.

10 TERMINATION

Without prejudice to any other rights or remedies which we may have, if you:

- materially breach any of the provisions of the Contract and, where the breach is remediable, fail to remedy it within 5 working days of receipt of a notice from us requiring its remediation;
- fail to pay the Price or any other sums due to us by the due date for payment and fail to remedy such non-payment within 10 working days of receipt of a notice from us requiring such payment;
- are a sole trader, partnership or company and you (or any partner if a partnership) become unable to pay your debts (within the meaning of Section 123 of the Insolvency Act 1986 or Section 268 of the Insolvency Act 1986 as the case may be) or are liquidated, wound up or have a petition for winding up presented against you or pass a resolution for winding up or a petition for the appointment of an administrator be presented against you or have any receiver or administrative receiver appointed in respect of all or any of your undertaking or assets or are subject to an interim order or commit any act of bankruptcy or make any arrangement or otherwise compound with your creditors;
- suffer or allow any execution, whether legal or equitable, to be levied on its property or obtained against it; or
- have entered into any other contract or agreement with us and a right of termination in relation to that contract or agreement has arisen including without limitation where you are an Authorised Distributor and have entered into a distribution agreement with us, we will have the right immediately to terminate the Contract on giving you notice of such termination in writing.

11 GENERAL

11.1 Subject to Condition 1.3, the Contract constitutes the entire agreement between you and us and cancels and supersedes any and all previous agreements (whether oral or written, express or implied) between you and us relating to the subject matter of the Contract. Except for the express written terms of the Contract, you and we acknowledge and agree that in entering into the Contract neither you nor we have relied on or been induced by any warranty, statement or representation of the other or any other person relating to the Contract. Nothing in the Contract will affect any liability of you or us for fraudulent misrepresentation.

11.2 If any provision of the Contract is found by any court, tribunal or administrative body of competent jurisdiction to be wholly or partly illegal, invalid, void, voidable, unenforceable or unreasonably it will to the extent of such illegality, invalidity, voidness, voidability, unenforceability or unreasonableness be deemed severable and the remaining provisions of the Contract and the remainder of such provision will continue in full force and effect.

11.3 Failure or delay by us in enforcing or partially enforcing any provision of the Contract will not be construed as a waiver of any of our rights under the Contract.

11.4 No term of the Contract will be enforceable by virtue of the Contracts (Rights of Third Parties) Act 1999 by any person that is not a party to the Contract.

11.5 If you sell or dispose of the Goods you can assign the terms of the Warranty provided that the sale is on an arm's length basis and is a bona fide transaction. Except as provided in this Condition 11.5 you are not entitled to assign all or any part of this Contract.

12 LAW

The Contract will be governed by and construed in accordance with the laws of England and you and we submit to the non-exclusive jurisdiction of the English courts.

A

Aluminium Floors

HB403, HB506, HB511	90
HB401, HB505, HB510	96
TT2515, TT3017, TT3621	123

Aluminium Mudguards

GP	133
Q	144

Antiluce Fasteners

	64
--	----

Axles

	39, 40
--	--------

B

Backplates

Alko	33
Knott	31,32

Back Rails

	109
--	-----

Batteries

	124
--	-----

Battery for Trailer Cam

	28
--	----

Bearings

	37, 38, 40
--	------------

Bellows

Alko	52
Bradley	53
Knott	48,49,50,51

Body Clamp CT

	118
--	-----

Brakes

Alko	33
Knott	31,32

Brake Cables

	34,35
--	-------

Brake Rods

	34
--	----

Breakaway Cables

Bradley	53
Knott	48,49,50,51
Bump Stops	40
Bushes	65

Breast/ Breeching Bars

HB511	85
HB506	86
HB510	93
HB505	94

Bucket Rests

GP	133
GX	128 - 132

C

Camera

	27,28
--	-------

Canopies

	145
--	-----

Cargo Straps

	58
--	----

Centre Partitions

Eventa	100
HB511	85
HB506	86
HB510	93
HB505	94
HB510XL, HB610	98
Livestock	104

Clothing

	26
--	----

Coiled Springs

	61
--	----

Compensator Rocker/ Beam

	34
--	----

Couplings

Alko	52
Bradley	53
Knott	48,49,50,51
Unbraked	47

Coupling Lock

	57
--	----

Cross Division

	105,144
--	---------

Cross Division spares

	106
--	-----

D

Dampers

Alko	52
Bradley	53
Knott	48,49,50,51

Door Stays

	62
--	----

Door Stops

	65
--	----

Drawbars

CT166, CT167	118
CT177	135
GX	128 - 131
Flatbed	115
TT105G, TT126	126
Unbraked	140,141,142

Dropside Kits and Components

Beavertail	117
CT166, CT167	118
Eurolight	116
Flatbed	112
TB Range	119, 120
TT2515, TT3017, TT3621	123
TT85G, TT105G, TT126	126



F

Flooring	148, 149
Footplates	
Boxvan	139
HB401, HB505 & HB510	97
Livestock	103
Front Panel Kits	90

G

Gas Springs	60, 95, 99
Gift Ideas	29
GRP Nosecones	98
GRP Panels	137
GRP Roof Panels	97
GRP Wind Deflectors	110

H

Haynet Rails	91
Headboards	
Beavertail	117
CT166, CT167	118
Flatbed	113
TB Range	119
TT2515, TT3017, TT3621	122
TT85G, TT105G, TT126	126
Hinges	60, 107, 137, 138
Hinge Pins	60

Horsebox Panels	146, 147
Hubs	37, 38
Hub Caps	37, 38, 40
Hydraulic Power Packs	
Fenner/ SPX	127
Fluidlink	127
Savery	125
Hydraulic Rams	
TB Range	120
Tipper Range	124

I

Inspection Door Fittings	63, 95, 98, 137
Inspection Door Kits	
Box van	139
HB	89
Livestock	102

J

Jockey Wheels	54
----------------------	----

K

Kickboard	87, 96, 98
------------------	------------

L

Ladder Racks	
Beavertail	117
General Duty	111

Flatbed	113
GX	128 - 131
TT2515, TT3017, TT3621	123
Unbraked	141, 143

Lashing Ring Kits	58, 116
--------------------------	---------

Leaf Springs	40
---------------------	----

Linch Pins	64
-------------------	----

Lighting

Accessories	73
Fog lamps	69
Interior lamps	72
Lighting Kits	72
Light Leads	73
Marker Lamps	70, 71
Number Plate Lamps	69
Rear Combination Lamps	67
Rear lamp lenses	68
Reflectors	72
Reverse lamps	69

Light Guards

TT2515, TT3017, TT3621	123
Unbraked	141, 142

Loading Skids

Beavertail	117
CT177	135
Eurolight	116
Flatbed	113
GH	134
GP	133
GX	128 - 132
TT2515, TT3017, TT3621	123

Locking Wheel Bolts	41
----------------------------	----



M		R		Roof Kits	90
Manual Pump	118,124	Rainflaps	45	Roof / Roof Rack – Q	144
Matting	90,96	Ramps		Roof Sheets	
Mesh Side Kits & Components		Beavertail	117	Boxvan	137
Beavertail	117	General Duty	111	Horsebox	97
CT166, CT167	118	GH	134	Livestock	102
General Duty	111	GP	133	Rope Hooks	58
Flatbed	114	GX	128 - 132	Rubber Matting	
GP	133	Flatbed	113	Eventa	99
Q Range	144	TB Range	119	HB403, HB506 & HB511	90
TB Range	119	Ramp Fasteners	62	HB401, HB505 & HB510	96
TT2515, TT3017, TT3621	121	Ramp Gates	109	HB510XL, HB610	98
TT85G, TT105G, TT126	126	Ramp Gate Extensions	109		
Unbraked	141,142,143	Ramp Hinge Tubes / kits	60	S	
Mudguards	44,45,84	Ramp Planks	101	Savery Pump	125
GX	128 - 131	Ramp Spares	88,95,98,101, 138	Seals	
Mudguard Brackets	44,45	Ramp Springs	61, 100,101	Box Van	137
Mudflaps	44,45	Rear Corner Pillars		Canopy	145
		Livestock	101	Horsebox	95,125
		Rear Doors	88	Oil	38
P		Rear Protection Brackets – Boxvan	139	Suspension Axles	40
Padding	87	Receiver Tracks	58	Seal Kits	120,124,127
Parking Socket	140	Remote Controls	125,127	Security Lock	57
Propstands	54,55,91,123	Roller Shutters	138	Sheep Deck Components	107
		Roof Channels	102	Sheep Deck Barriers	108
				Shoring Poles	58



Skid Storage	
Beavertail	117
Eurolight	116
TT2515, TT3017, TT3621	123
Solid Side Kits	
TT2515, TT3017, TT3621	121
Q range	144
Spacers	65
Spare Wheel Brackets	43
Spare Wheel Covers	43, 100
Spare Wheel Kits	43, 134
Spring Bolts	62
Sump Tanks	110
Suspension Components	40
Suspension Cross Members	
Flatbed	115
Swivel Hitch	47, 144

T

Tailboards	
Beavertail	117
CT166, CT167	118
General Duty	111
Flatbed	113
TB Range	119
TT2515, TT3017, TT3621	122
TT85G, TT105G, TT126	126

Unbraked	141, 142, 143
Tack Packs	91
Tarpaulins	141
Toolboxes	123, 134
Trailer Aid	25,41
Trailer Cam	27,28
Trailer Covers	25, 92, 100
Trailer Toys	29
Treadplates	149
Tyres	41

U

U Bolts	40
Umbrella	29
Unbraked Couplings	47

V

Vent Gap Kits	103
Vents	
Horsebox	87, 95
Livestock	102

W

Washers	65
Wheel Assemblies	42
Wheel Centres	42
Wheel Chock Kits	
CT115,136	136
TB Range	119
Wheel Bolts	41
Wheel Trims	41
Wheel Wrench	41
Winches	
Mechanical Winches	79,81,82
Superwinch	78
Winch Brackets	77
Winch Kits	77
Winch Spares	78, 80,81
Windows	87, 99
Wiring Looms	73



IFOR WILLIAMS TRAILERS LTD
Cynwyd, Corwen, Denbighshire LL21 0LB
Tel: 0845 4082505

spares@iwt.co.uk
www.iwt.co.uk

Distributors throughout the UK & Europe

